



SEMY

ENGINEERING & CONSULTING GMBH

 **IZELTAS**[®]

2024 CATALOGUE



GRAND MASTER

WORKSHOP TROLLEY

251 Pcs.

Size: 470x1224x964

Code: 13000005434



 **ZELTAS**[®]

A - INCLUDED CASES

1. Products used in accord with normal use conditions but found to have production or material errors will be repaired or if this is not possible replaced immediately under lifetime warranty.

B - EXCLUDED CASES

Products used under any of the conditions listed below are excluded from the warranty scope and cannot be replaced with new ones:

1. Products used outside the intended purpose or instructions of use;
2. Products deformed or broken due to excessive forcing, pipe attachment or hammer impact;
3. Products whose original form is altered by the user by stoning, grinding, perforation or welding;
4. Products which lost their function due to being left in dusty, moist or muddy environments without necessary protective maintenance after use;
5. Products which became rusted or corroded due to being stored in unsuitable, moist environments for extended periods of time;
6. Products which are used for a long period of time or which have completed their useful life and accordingly have become old, worn out and deformed.

RULES FOR SAFE AND CORRECT USE OF HAND TOOL

A - PRACTICAL RULES:

1. Make sure size of the wrench is appropriate for the work piece.
2. Make sure the tool is positioned correctly during use.
3. Frequently control the tool. Replace worn or damaged tools.
4. Use the tool in accord with instructions of use. Do not place too much load on the tool.
5. Especially beware of the point that the impact surface of a hammer must be larger than the impacted surface.
6. Always use appropriate accessories for pneumatic tools. (Also make sure the pneumatic system is properly lubricated.)
7. Use personal protection equipment appropriate for work conditions.
8. Always make sure to lock lids and moving parts of wheeled set cabinets before moving them.
9. Make sure to lock brakes of the wheeled set cabinets before working on them.
10. Use VDE certified products made in accord with TS EN IEC 60900 Standard in high voltage work environments.
11. Make sure to dry and lightly lubricate tools after use in moist and wet environments.

B- ACTIONS TO AVOID:

1. In case of use with extensions like pipes, etc. do not exceed the specified torque value (especially in case of all wrenches).
2. Do not use any tool outside of its intended purpose (e.g. do not use a screwdriver as a lever or a chisel).
3. To not force the tool (e.g. wrenches and screwdrivers) by using excessive force (by pipe attachment or hammer impact).
4. Never use the tool to hit another object harder than the tool (e.g. hammer and chisels).
5. Do not alter the tools (in form or partially).
6. Do not use metric sized wrenches on inch sized bolts or vice-versa.
7. Do not use worn out or faulty tools.
8. Do not leave multiple drawers open when using the wheeled set cabinet and do not move the cabinet while the drawers are open.
9. Do not perform grinding, stoning, welding, etc. on the tool in order to improve its function.
10. Do not expose the tool to conditions that might result in loss of paint or coating during use. Otherwise corrosion resistance of the tool will be affected.
11. Never use VDE certified products with damaged or worn isolation or handle in high voltage work environments.
12. Never attempt to dismantle the internal assembly of the tester. Testers are suitable for use in the 110 – 250 VAC operation range.
13. Always use the right tool for the right job and follow the conditions and rules of correct usage detailed above.

Half a century of reliability

Faith is the essential step on the journey to achieve utmost quality.

As the first and largest hand tool manufacturer of Turkey, İZELTAŞ, had this faith as it started its journey in 1968 in İzmir, the beautiful city in the Aegean region. Its establishment, consisting of 100% national capital, İZELTAŞ has grown in years into an industrial giant with huge facilities equipped with state-of-the-art technologies and over 4500 products. Exporting to more than 40 countries, the company is a prominent contributor to not only the Turkish economy but also the community.

Along with manufacturing hand tools, İZELTAŞ produces forged steel parts for various industries like automotive, construction, maritime, mining, aviation, defence, agriculture and infrastructure.

Newer and better

İZELTAŞ is one of the few fully integrated factories in the world that consists of die tooling, forging, processing, heat processing, chrome-nickel plating, dyeing, pvc coating, plastic injection and marking departments. Every stage of the production is tested for quality assurance using physical, metallurgical, chemical and electrical methods. R&D and innovation are the key words that empower İZELTAŞ as a company which embraces development and improvement as its main philosophy.

İZELTAŞ is an accredited R&D Center by the Ministry of Science, Industry and Technology and has been certified with the following: ISO 9001 Quality Management System, ISO/IEC 27001 Informationsecurity Management System, OHSAS 18001 Occupational Health and Safety Management System, ISO 14001 Environment Management System, ISO 50001 Energy Management System certification, TSE, TSEK and VDE GS product certification.

Safety before production

Humans are the most significant factors of any industry and their labour is precious. Health and safety awareness is the fundamental policy of İZELTAŞ. The company continuously organizes training programs on occupational health and safety which emphasise that safety comes first and it is not possible to fix humans by changing the damaged organs with spare ones.

Customer satisfaction

Another fundamental policy of İZELTAŞ is the customer satisfaction. The company is dedicated to serve its customers and protect their rights as consumers.

Hence...

- We are the first brand that comes to mind in the hand tools industry
- We are valued almost as a part of the families of our consumer
- We have proved ourselves worthy of the statement "Made in Turkey"
- We have been the first choice of the consumers for durability over the years















Our power, enthusiasm and faith are derived from our distinguished dealers and consumers.

We are proud to have become a world brand with our 850 employees who strive everyday to contribute to the productivity of the company, creating an added value for the economy and our community.

To many successful years to come!



*"We don't just produce hand tools;
we build everything with hand tools."*

| | | |
|---|---------|---|
| Tool Trolleys, Tool Boxes | 6-69 |  |
| Wrenches | 70-92 |  |
| Sockets and Rim Wrenches | 93-120 |  |
| Air Pressured Sockets and Rim Wrenches | 121-129 |  |
| Pipe Wrenches and Pliers | 130-150 |  |
| 1000V Product Group | 151-159 |  |
| Screwdrivers and Hex Key Wrenches | 160-184 |  |
| Chiseles and Hammers | 185-192 |  |
| General Hand Tools | 193-205 |  |
| Utility Knives | 206-210 |  |
| Shears | 211-218 |  |
| Pullers | 219-225 |  |
| Spare Parts | 227-231 |  |
| Commercial Display Stands | 233-236 |  |
| Technical Information | 237-247 |  |

TOOL TROLLEYS, TOOL BOXES AND HAND TOOL SETS

Tool Cabinets
Tool Boxes
Service Tables
Tool Sets
Lockers



Grand Master Series Workshop Trolley (7 Drawers)



● 18 mm solid wood top



● Ergonomic handle



● %100 extendable telescopic slides



● 2 swivel castors with brake
2 fixed castors ø 150mm



● Central lock
● Handgrip Lock system
● Anti tilt system



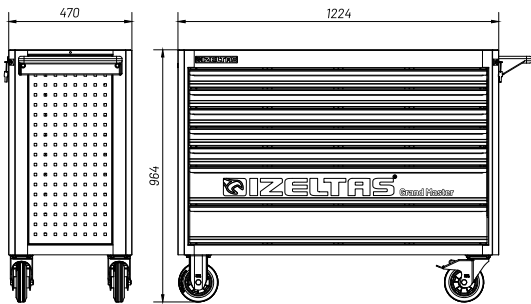
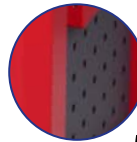

● High strength electrostatic powder coating.



Size: 470x1224x964 mm

Made of sheet metal, Electrostatic paint

| CODE | DRAWERS |  1098x400x60 |  1098x400x135 |  Kg | COLORS |
|------|---------|---|--|--|--------|
|------|---------|---|--|--|--------|

| | | | | | |
|------------------------------|---|----|----|-------|---|
| 8246 32 1007 | 7 | 5X | 2X | 125.7 | |
| 13000 005434 Full 251 Pcs | 7 | 5X | 2X | 125.7 | <div style="background-color: black; color: white; padding: 2px;">RAL 9005 GOF</div> <div style="background-color: red; color: white; padding: 2px;">RAL 3020 GOF</div> |



1. Drawer



Left Side

Code 13000 005590

| CODE | CONTENTS |  |
|------|---|---|
| 0330 | Combination Werench Long Pattern 6 - 7 - 8 - 9 - 10 - 11 - 12 - 13 - 14 - 15 - 16 - 17 - 18 - 19 - 20 - 21 - 22 - 23 - 24 - 25 - 26 - 27 - 28 mm | 23 |

Right Side

Code 13000 005589

| CODE | CONTENTS |  |
|------|--|---|
| 0330 | Combination Werench Long Pattern 29 - 30 - 32 - 34 - 36 - 41 mm | 6 |

2. Drawer

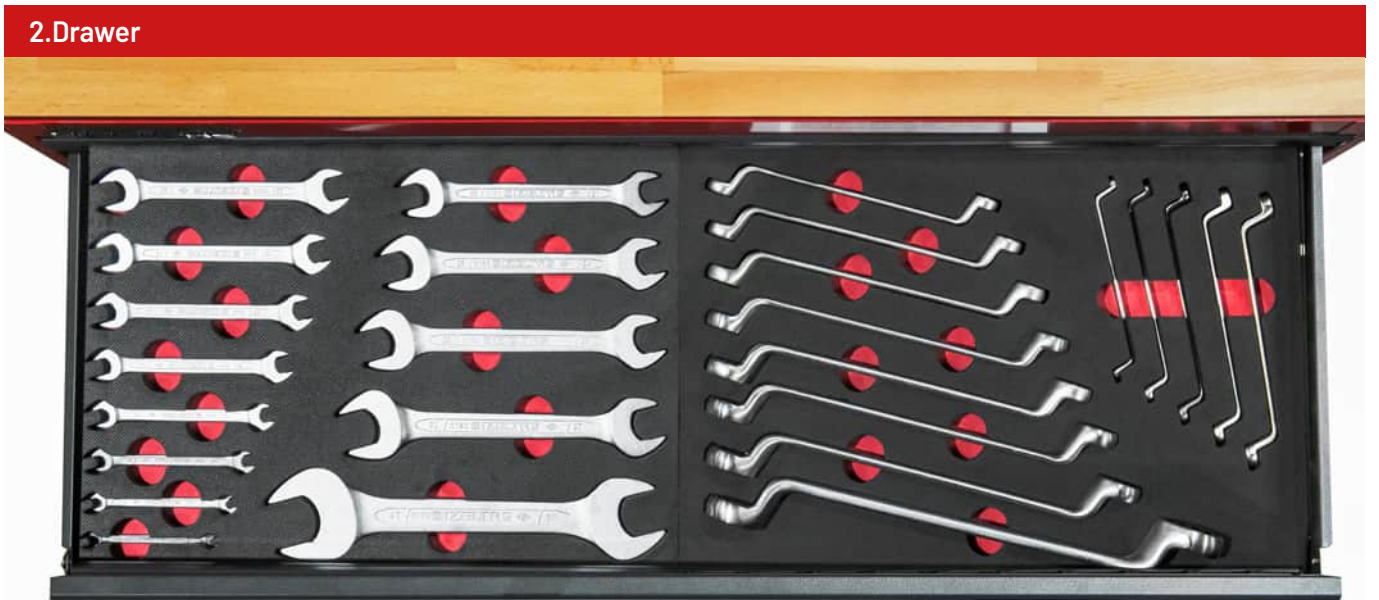

Left Side

Code 13000 005591

| CODE | CONTENTS |  |
|------|--|---|
| 0130 | Double Ended Open Jaw Wrench Long Pattern 6x7 - 8x9 - 10x11 - 12x13 - 14x15 - 16x17 - 18x19 - 20x22 - 21x23 - 24x26 - 25x28 - 27x32 - 36x41 mm | 13 |

Right Side

Code 13000 005592

| CODE | CONTENTS |  |
|------|--|---|
| 0430 | Double Ended Ring Wrench 6x7 - 8x9 - 10x11 - 12x13 - 14x15 - 16x17 - 18x19 - 20x22 - 21x23 - 24x26 - 25x28 - 27x32 - 36x41 mm | 13 |

3.Drawer



Left Side

Code 13000 005594

| CODE | CONTENTS | |
|------|---|---|
| 3301 | Circlip Pliers, External (Flat) 180 - 295 mm | 2 |
| 3311 | Circlip Pliers, External (Bent) 170 - 275 mm | 2 |
| 3321 | Circlip Pliers, Internal (Flat) 180 - 310 mm | 2 |
| 3331 | Circlip Pliers, Internal (Bent) 170 - 290 mm | 2 |

Right Side

Code 13000 005593

| CODE | CONTENTS | |
|-------|--------------------------------------|---|
| 0600 | Adjustable Wrench 12" | 1 |
| 2400 | Waterpump Pliers Universal 240 mm | 1 |
| 2500 | Universal Grip 250 mm | 1 |
| 3020 | Combination Pliers 180 mm | 1 |
| 3220 | Long Nose Pliers | 1 |
| 3700 | Side Cutting Pliers 180 mm | 1 |
| 3425 | Hose Clamp Pliers 235mm | 1 |
| 07415 | Hand Brush (Wooden Handle) | 1 |
| 6380 | Oil Filter Wrench With Double Chain | 1 |
| 6820 | Tinman's Snip 250mm | 1 |



4. Drawer

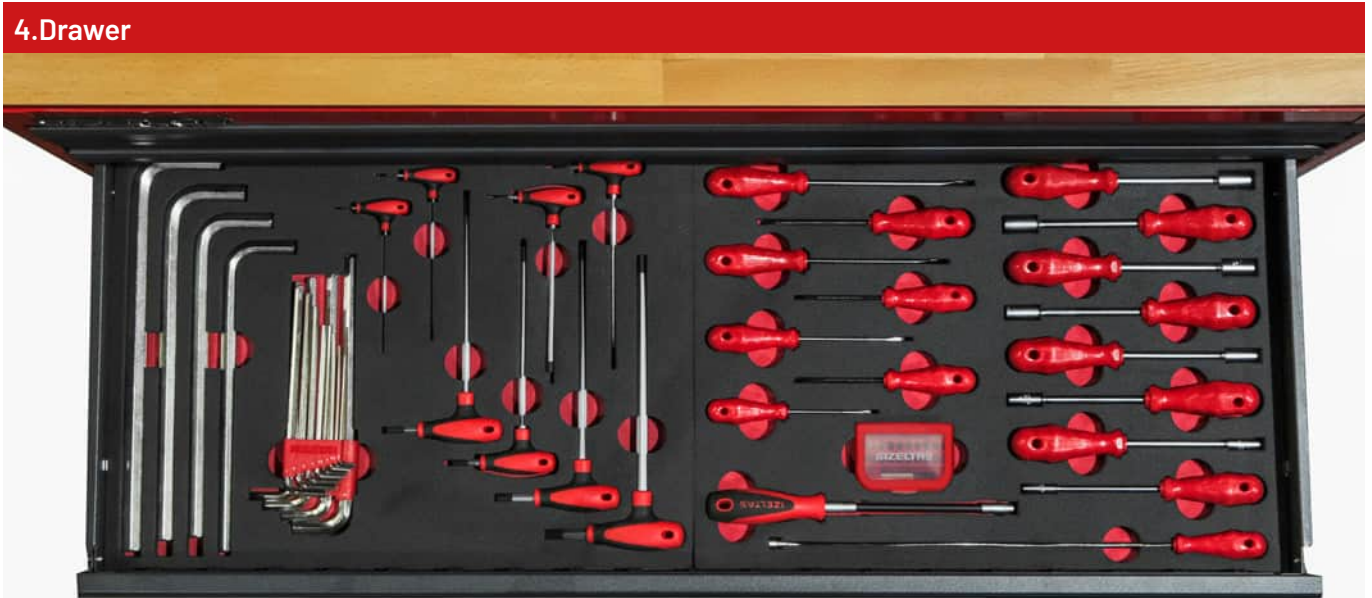

Left Side

Code 13000 005595

| CODE | CONTENTS |  |
|------|---|---|
| 4903 | Hex Key Wrench Set Long Pattern | 12 |
| 4903 | Hex Key Wrench Long Pattern 14 - 16 - 17 - 19 mm | 4 |
| 4920 | Hex Key Wrench T Handle Set | 8 |

Right Side

Code 13000 005596

| CODE | CONTENTS |  |
|------|---|---|
| 4300 | Screwdriver, Opak, Flat 3x80 - 4x80 - 4x100 - 5x125 - 6x150 mm | 5 |
| 4320 | Screwdriver, Opak, Phillips 4.5x80 - 6x100 mm | 2 |
| 4770 | Nut Spinner 6 - 7 - 8 - 9 - 10 - 11 - 12 - 13 mm | 8 |
| 4780 | Screwdriver, Magnetic Bit Holder (Long) | 1 |
| 4800 | 6.3 x 120 | 31 |
| 6220 | Flexible Magnet Holder 1000 gr | 1 |

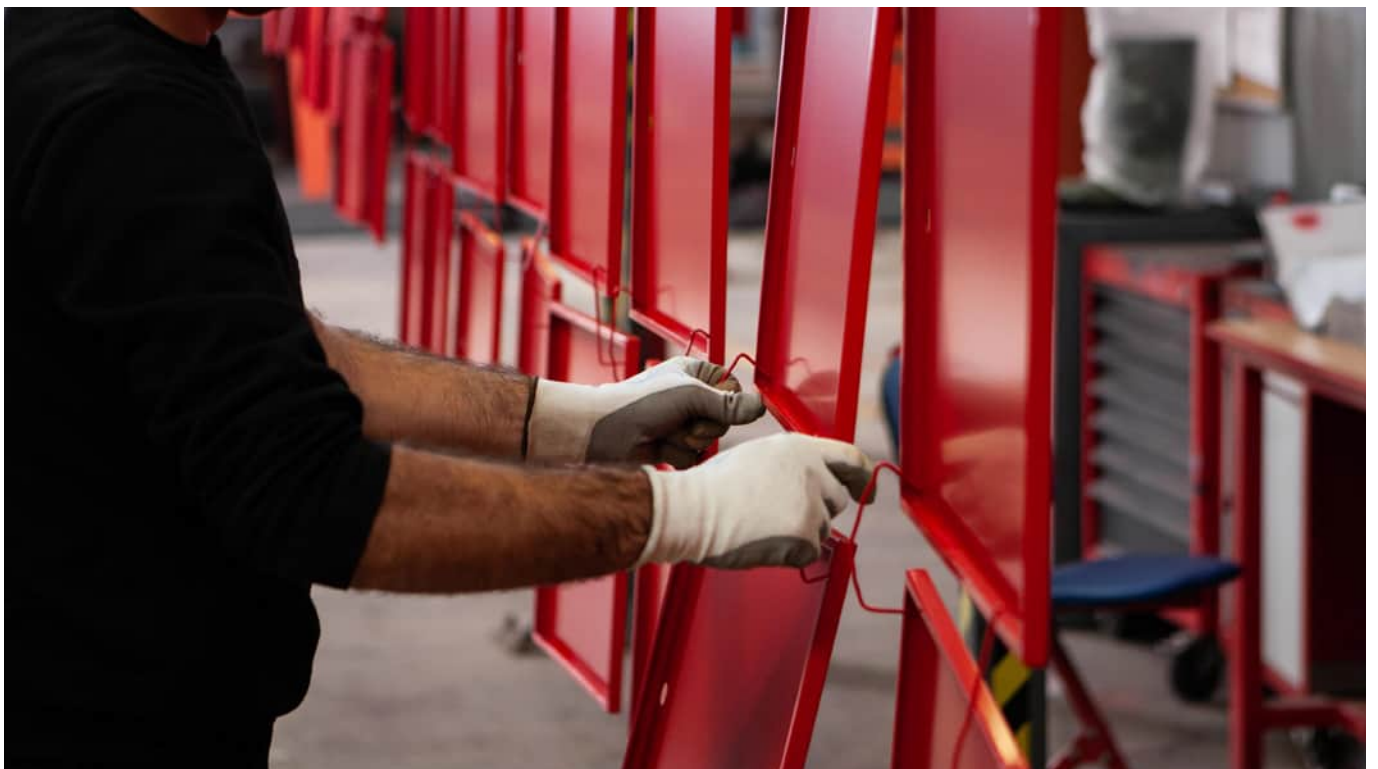

5.Drawer



Left Side

Code 13000 005598

| CODE | CONTENTS | |
|------|--|----|
| 0340 | 1/2" Combination Wrench With Ratchet 10 - 13 - 17 - 19 mm | 4 |
| 1113 | Socket Wrench 6 Points 10 - 11 - 12 - 13 - 14 - 15 - 16 - 17 - 18 - 19 - 21 - 22 - 23 - 24 26 - 27 - 28 - 30 - 32 mm | 19 |
| 1113 | 1/2" Hexagonal Bit Socket Wrench 5 - 6 - 7 - 8 - 10 - 12 - 14 mm | 7 |
| 1113 | 1/2" Star Torx® Bit Socket Wrench T25 - T27 - T30 - T40 - T45 - T50 - T55 - T60 | 8 |
| 1513 | 1/2" Ratchet Handle 250mm | 1 |
| 1513 | 1/2" Extension Bar 125 - 250 mm | 2 |
| 1513 | 1/2" Sliding T Handle 250mm | 1 |
| 1513 | 1/2" Universal Joint 70mm | 1 |
| 1513 | 1/2" Fx3/4"M. Adapter | 1 |
| 1519 | 3/4" Fx1/2"M Adapter | 1 |

Right Side

Code 13000 005597

| CODE | CONTENTS | |
|------|--|----|
| 1113 | 1/2" Impact Socket Wrench 6 Points 10 - 11 - 12 - 13 - 14 - 15 - 16 - 17 - 18 - 19 - 21 - 22 - 24 - 27 - 30 - 32 mm | 16 |
| 1513 | 1/2" Fx3/4"M Impact Socket Adapter | 1 |
| 1513 | 1/2" Impact Socket Extension Bar 125mm | 1 |
| 1513 | 1/2" Impact Socket Universal Joint 75mm | 1 |
| 1119 | 3/4" Impact Socket Wrench 6 Points 19 - 21 - 22 - 24 - 27 - 30 - 32 - 34 - 36 - 41 - 46 mm | 11 |
| 1519 | 3/4" Impact Socket Extension Bar 250mm | 1 |
| 1519 | 3/4" Impact Socket Universal Joint 108mm | 1 |
| 1519 | 3/4" F x 1/2"M Impact Socket Adapter | 1 |



6.Drawer



Left Side

Code 13000 005600

| CODE | CONTENTS |  |
|-------|------------------------------------|---|
| 5010 | Wood Chisel 22mm | 1 |
| 5800 | Machinist Hammer 2000 - 500 gr | 2 |
| 5850 | Plastic Hammer | 1 |
| 05881 | Plastic Steel Case Measuring Tapes | 1 |
| | Prybar 400mm | 1 |
| 5500 | Flat Cold Chisel 250mm | 1 |
| | Antifreeze tester | 1 |

Right Side

Code 13000 005599

| CODE | CONTENTS |  |
|------|--|---|
| 1119 | 3/4" Socket Wrench 6 Points 22 - 24 - 27 - 30 - 32 - 34 - 36 - 41 - 46 - 50 - 55 - 60 mm | 12 |
| 1519 | 3/4" Ratchet Handle 510mm | 1 |
| 1519 | 3/4" Extension Bar 200 - 400 mm | 2 |
| 1519 | 3/4" Sliding T Handle 500mm | 1 |

7.Drawer

Grease Gun



Hose for Grease Gun



Tyre Lever, Bent



| CODE | CONTENTS |  |
|------|----------------------------|---|
| 6230 | Grease Gun | 1 |
| 6230 | Hose for Grease Gun | 1 |
| 6360 | Tyre Lever, Bent 600 mm | 2 |



Premium Series Workshop Trolley (5-7 Drawers)



- Resistant and solid top cover having 6 divisions

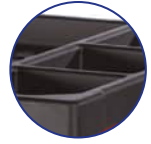

- %100 extendable telescopic slides



- Central lock
- Handgrip Lock system
- Anti tilt system



- 2 swivel castors with brake
- 2 fixed castors ø 125mm



- Standard handle



- Plastic corner protection



- High strength electrostatic powder coating

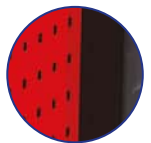

- Paper Roll Holder x1
- Bottle & Tins Holder x2
- Hanger x1

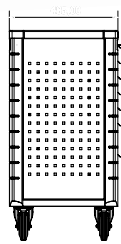
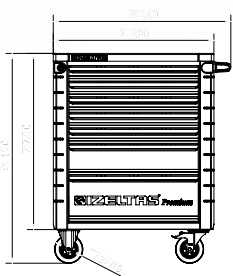

Size: 485x717x944 mm
Made of sheet metal, Electrostatic paint

RAL 9005 GOF
RAL 3020 GOF

| CODE | DRAWERS | 400x548x63 | 400x548x132 | 400x548x202 | |
|------------------------------|---------|------------|-------------|-------------|----|
| 8245 32 1005 | 5 | 2X | 1X | 2X | 64 |
| 8245 32 1007 | 7 | 5X | 1X | 1X | 70 |
| 8245 00 7096 Full 250 Pcs | 7 | 5X | 1X | 1X | |

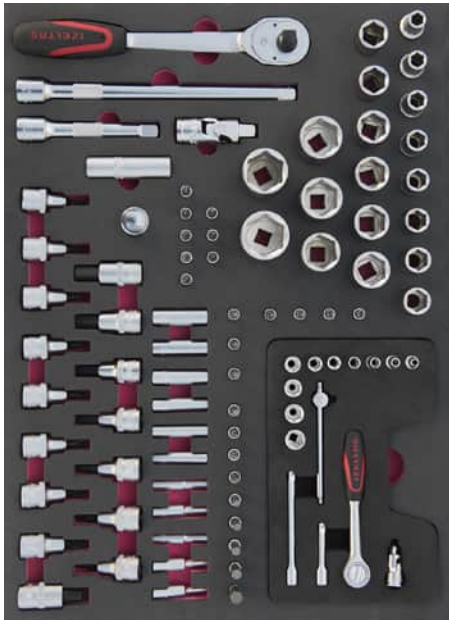
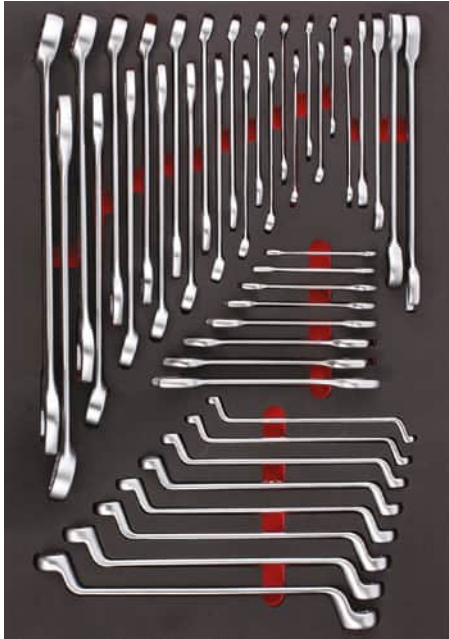

| 1.Drawer | | Code 8245001042 |
|----------|--|--------------------------|
| CODE | CONTENTS | <input type="checkbox"/> |
| 0100 | D/E Open Jaw Wrenches Short Pattern 6x7-8x9-10x11-12x13-14x15-16x17-18x19-20x22 | 8 |
| 0320 | Combination wrenches Short Pattern 6-7-8-9-10-11-12-13-14-15-16-17-18-19-20-21-22-24-27-30-32 | 21 |
| 0430 | Ring Wrenches 6x7-8x9-10x11-12x13-14x15-16x17-18x19-20x22 | 8 |
| 0340 | Combination Wrench With Ratchet 8-10-13-17-19 | 5 |

| 2.Drawer | | Code 8245002094 |
|----------|---|--------------------------|
| CODE | CONTENTS | <input type="checkbox"/> |
| 1107 | 1/4" Hexagonal Bits Socket 2,5-3-4-5-6-7-8-10 | 8 |
| 1107 | 1/4"/ Torx Bits Socket T8-T9-T10-T15-T20-T25-T27-T30-T40 | 9 |
| 1107 | 1/4" Phillips Bits Socket 1/4" PH1-PH2-PH3 | 3 |
| 1107 | 1/4" Slotted Bits Socket 3-4-5,5-6,5 | 4 |
| 1107 | 1/4" Deep Socket Wrench 6 Point 4-5-5,5-6-7-8-9-10-11-12-13 | 11 |
| 1113 | 1/4" Hexagonal Bits Socket 5-6-7-8-10-12-14 | 7 |
| 1113 | 1/2" Torx Bits Socket T20-T25-T27-T30-T40-T45-T50-T55-T60 | 9 |
| 1107 | 4 - 5 - 6 7 - 8 - 9 - 10 11 - 12 - 13 Six Points | 15 |
| 1113 | 1/2" Socket Wrench Set 1/4" Ratchet Handle 1/4" Universal Joint 1/4" Sliding T Handle 1/4" Extension Bar 50-100 mm | 1 |
| 1113 | 1/2" Spark Plug Socket With Rubber 16 mm | 1 |
| 1113 | 10 - 11 - 12 - 13 - 14 15 - 16 - 17 - 18 - 19 21 - 22 - 23 - 24 26 - 27 - 28 - 30 - 32 Six Points | 24 |
| | 1/2" Socket Wrench Set 1/2" Ratchet Handle 1/2" Universal Joint 1/2" Sliding T Handle Adapter 1/2" Extension Bar 125-250 mm | |

| 3.Drawer | | Code 8245003014 |
|----------|---|--------------------------|
| CODE | CONTENTS | <input type="checkbox"/> |
| 3700 | Side Cutting Pliers 160 mm | 1 |
| 3020 | Combination Pliers 180 mm | 1 |
| 3220 | Nose Pliers Flat 180 mm | 1 |
| 4300 | Screwdriver, Flat 3x80-5x125-7x150 | 3 |
| 4320 | Screwdriver, Philips 3x60-4.5x80-6x100-8x150 | 4 |
| 3301 | Circlip Pliers, External Flat 140-180mm | 2 |
| 3321 | Circlip Pliers, Internal Flat 140-180mm | 2 |



4. Drawer Code 8245004043

| CODE | CONTENTS |  |
|------|---|---|
| 4770 | Nutspinner 6-7-8-9-10-13 | 6 |
| 4910 | Torx Key Wrench Set T9-T10-T15-T20-T25-T27-T30-T40 | 8 |
| 4900 | Hex Key Wrench Set 2-2.5-3-3.5-4-5-6-7-8-9-10-12 | 12 |
| 4906 | Hex key Wrench Ballpoint Long Pattern Set 1.5-2-2.5-3-4-5-6-8-10 | 9 |
| 4920 | T Type Hex Key Wrench 2.5-3-4-5-6-7-8-10 | 8 |



5. Drawer Code 8245005043

| CODE | CONTENTS |  |
|-------|--|---|
| 4565 | Car Voltage Tester 135mm | 1 |
| 07415 | Hand Brush 4 Rows | 1 |
| 2400 | Waterpump Pliers Universal 240 mm | 1 |
| 2500 | Universal Grip 250 mm | 1 |
| 0600 | Adjustable Wrench 10" | 1 |
| 4780 | Screwdriver, Magnetic Bit Holder 6.3x120 | 1 |
| 4800 | Bits Set in plastic case | 31 |
| 4110 | Screwdriver, Stubby, Flat 6.5x25 | 1 |
| 4130 | Screwdriver, Stubby, Phillips 6x25 | 1 |
| 5500 | Flat Cold Chisel 150 mm | 1 |
| 5800 | Machinist's Hammer 300-1500 gr | 2 |
| 6350 | Tyre Lever 500 mm | 1 |



6. Drawer Code 8245006009

| CODE | CONTENTS |  |
|-------|---|---|
| 1840 | Swivel Handle With Sliding T 1/2" | 1 |
| 6230 | Grease Gun 500cc | 1 |
| 06375 | Adjustable Slot Type Oil Filter Wrench | 1 |
| 6225 | Oiler With Flexible Spout 200cc | 1 |
| 1113 | Impact Socket Wrench 6 Points (mm) 10-13-17-19-21-24 | 6 |
| 1108 | 6 Point Impact Socket Wrench, Long Type (mm) 10-13-17-19-21-24 | 6 |



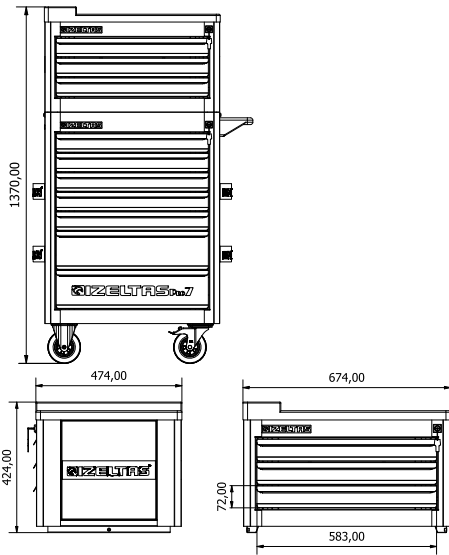

Pro Series Workshop Trolley Top Unit With 3 Drawers



- Handgrip Lock System and Antitilt System
- Telescopic Slides Which Are %100 extendable
- Central Lock System
- Durable ABS Worktop With 9 Divisions
- 2 Side Holders
- 10 Drawer Separators
- 1 Back Holder

Size: 474x674x424 mm
 Made of sheet metal, Electrostatic paint

| CODE | DRAWERS |  3.5 kg |  Kg | COLORS |
|--------------|---------|--|--|---|
| 13000 005279 | 3 | 400x548x68 | 29.2 | <div style="background-color: #cccccc; padding: 2px;">RAL 7035 GOF</div> <div style="background-color: #cc0000; color: white; padding: 2px;">RAL 3020 GOF</div> |

Pro Series Workshop Trolley (5-6-7-8 Drawers)



● Central lock system, handgrip lock system and antitilt system



● Telescopic slides which are %100 extendable



● 9 durable ABS worktop with divisions



● 2 swivel castors with brake, 2 fixed castors Ø 125mm



● High strength electrostatic powder coating



● 6 tool holders

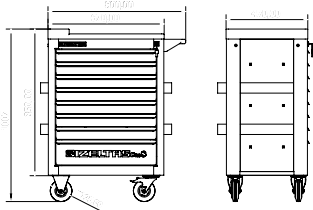

Size: 470x670x1007 mm

Made of sheet metal, Electrostatic paint





RAL 7035 GOF
RAL 3020 GOF

RAL 7035 GOF
RAL 5003 GOF

RAL 7035 GOF
RAL 7016 GOF

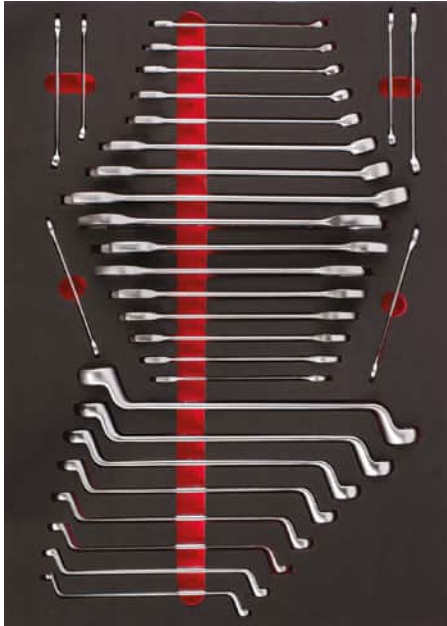
| CODE | DRAWERS | 35 kg | 35 kg | 35 kg | Kg | COLORS |
|--------------|---------|------------|-------------|-------------|----|--------------|
| | | 400x548x68 | 400x548x143 | 400x548x218 | | |
| 8241 32 1005 | 5 | 1X | 4X | -- | 59 | |
| 8241 32 1006 | 6 | 4X | 1X | 1X | 62 | RAL 7035 GOF |
| 8241 32 1007 | 7 | 5X | 2X | -- | 65 | RAL 3020 GOF |
| 8241 32 1008 | 8 | 7X | 1X | -- | 67 | |
| 8241 32 2005 | 5 | 1X | 4X | -- | 59 | |
| 8241 32 2006 | 6 | 4X | 1X | 1X | 62 | RAL 7035 GOF |
| 8241 32 2007 | 7 | 5X | 2X | -- | 65 | RAL 5003 GOF |
| 8241 32 2008 | 8 | 7X | 1X | -- | 67 | |
| 8241 32 3005 | 5 | 1X | 4X | -- | 59 | |
| 8241 32 3006 | 6 | 4X | 1X | 1X | 62 | RAL 7035 GOF |
| 8241 32 3007 | 7 | 5X | 2X | -- | 65 | RAL 7016 GOF |
| 8241 32 3008 | 8 | 7X | 1X | -- | 67 | |
| Full 206 Pcs | 8 | 7X | 1X | -- | | |



| 1.Drawer | | Code 8241001030 |
|----------|---|---|
| CODE | CONTENTS |  |
| 0130 | D/E Open Jaw Wrench Long Pattern 6x7 - 8x9 - 10x11 - 12x13 14x15 - 16x17 - 18x19 - 20x22 21x23 - 24x26 | 10 |
| 0330 | Combination Wrench Long Pattern 6 - 7 - 8 - 9 - 10 - 11 - 12 - 13 14 - 17 - 19 - 22 | 12 |
| 0430 | D/E Ring Wrench 6x7 - 8x9 - 10x11 - 12x13 14x15 - 16x17 18x19 - 20x22 | 8 |



| 2.Drawer | | Code 8241002072 |
|----------|---|---|
| CODE | CONTENTS |  |
| 1107 | 1/4" Socket Wrench Set 4 - 5 - 6 7 - 8 - 9 - 10 11 - 12 - 13 Six Point 1/4" Ratchet Handle 1/4" Universal Joint 1/4" Sliding T Handle 1/4" Extension Bar 50-100 mm | 15 |
| 1113 | 1/2" Socket Wrench Set 10 - 11 - 12 13 - 14 - 15 16 - 17 - 18 19 - 21 - 22 23 - 24 - 26 27 - 28 - 30 32 1/2" Ratchet Handle 1/2" Universal Joint 1/2" Sliding T Handle Adapter 1/2" Extension Bar 125-250 mm | 24 |
| 1113 | 1/2" Hexagonal Bits Sockets H5-H6-H7-H8-H10-H12-H14 | 7 |
| 1113 | 1/2" Star Bits Socket T20-T25-T27-T30-T40-T45-T50-T55-T60 | 9 |
| 0330 | Combination Wrench Long 16-18 | 2 |
| 4900 | Hex Key Wrench Set 2-2.5-3-3.5-4-5-6-7-8-9-10-12 | 12 |



| 3.Drawer | | Code 8241003051 |
|----------|---|---|
| CODE | CONTENTS |  |
| 07415 | Hand Brush 3 Rows | 1 |
| 6350 | Tyre Lever 400 mm | 1 |
| 6220 | Flexible Magnet Holder 500 gr | 1 |
| 4110 | Screwdriver , Stubby, Flat 6.5x25 | 1 |
| 4130 | Screwdriver , Stubby, Phillips 6x25 | 1 |
| 4770 | Nutspinner 6-7-8-9-10-13 | 6 |
| 4780 | Screwdriver, Magnetic Bit Holder 6.3x120 | 1 |
| 4905 | Hexkey Wrench Ballpoint Set 2-2,5-3-4-5-6-8-10 | 8 |
| 4800 | Bits Set in Plastic Case | 31 |



4. Drawer Code 8241004027

| CODE | CONTENTS | <input type="checkbox"/> |
|------|--|--------------------------|
| 0340 | Combination Wrench With Ratchet 10-13-17-19 | 4 |
| 4909 | Torx Allen Key T type T9-T10-T15-T20-T25-T27-T30-T40 | 8 |
| 1108 | 1/2" Deep Socket Wrench, six points 10-11-12-13-14-15-16-17-18-19 | 10 |
| 1113 | 1/2" Impact Socket Wrench 13-17-18-19-24 | 5 |



5. Drawer Code 8241005010

| CODE | CONTENTS | <input type="checkbox"/> |
|------|---------------------------------------|--------------------------|
| 3331 | Circlip Pliers, Internal, Bent 170 mm | 1 |
| 3321 | Circlip Pliers, Internal, Flat 180 mm | 1 |
| 3311 | Circlip Pliers, External, Bent 170 mm | 1 |
| 3301 | Circlip Pliers, External, Flat 180 mm | 1 |
| 3700 | Side Cutting Pliers, 160 mm | 1 |
| 3220 | Nose Pliers, 200 mm | 1 |
| 3020 | Combination Pliers, 180 mm | 1 |
| 2510 | Special Grip 250 mm | 1 |
| 0600 | Adjustable Jaw Wrench 10" | 1 |
| 2400 | Waterpump Pliers Universal 240 mm | 1 |



6. Drawer Code 8241006018

| CODE | CONTENTS | <input type="checkbox"/> |
|------|---|--------------------------|
| 4300 | Opak Screwdriver, Flat 4x100-5x125-6x150-8x175 | 4 |
| 4320 | Opak Screwdriver, Phillips 4.5x80-6x100 | 2 |
| 5800 | Mechanist Hammer 300 gr | 1 |
| 5850 | Plastic Hammer ø30 | 1 |
| 5545 | Drift Punch 5 mm | 1 |
| 5550 | Split Pin Punch 5 mm | 1 |
| 5540 | Center Punch 5x120 | 1 |
| 5500 | Flat Cold Chisel 150 mm | 1 |
| 4920 | T Type Hex Key Wrench 3-4-5-6-7-8 | 6 |

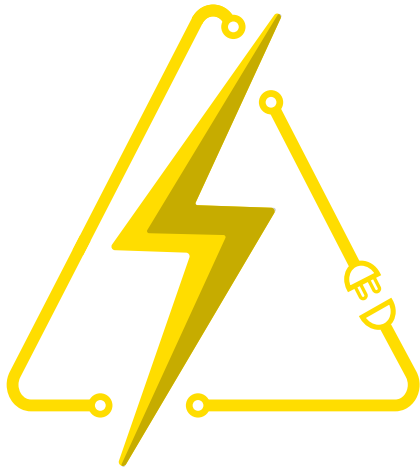

ELEKTRO



ELECTRO SERIES

Electro Series Workshop Trolley (7 Drawers)



- Resistant and solid top cover having 7 divisions

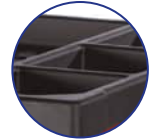

- %100 extendable telescopic slides



- Central lock
- Handgrip Lock system
- Anti tilt system



- 2 swivel castors with brake
- 2 fixed castors ø 125mm



- Standard handle



- Plastic corner protection

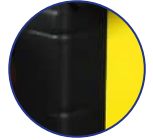

- High strength electrostatic gofrato powder coating

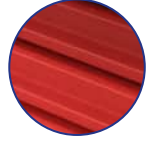

- Paper Roll Holder x1
- Bottle & Tins Holder x2
- Hanger x1



- Magnet Warning Sticker



- Perforated Panel for Hand Tools

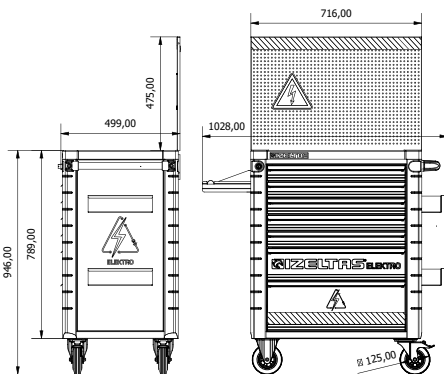

Size: 500x715x945 mm
Made of sheet metal, Electrostatic paint

RAL 9005 GOF
RAL 3020 GOF
RAL 1016

| CODE | DRAWERS | 35 kg | 35 kg | 35 kg | Kg |
|--------------------------|---------|------------------|-------------------|-------------------|----|
| 13000 005547 | 7 | 400x548x63 5X | 400x548x132 1X | 400x548x202 1X | |
| 13000 005548 Full 94 Pcs | 7 | 5X | 1X | 1X | |



| 1.Drawer | | Code 13000 005568 |
|--------------|--|---|
| CODE | CONTENTS |  |
| 0255 01 0010 | 10 mm / Single Ended Open Jaw Wrench Super Insulated | 1 |
| 0255 01 0011 | 11 mm / Single Ended Open Jaw Wrench Super Insulated | 1 |
| 0255 01 0012 | 12 mm / Single Ended Open Jaw Wrench Super Insulated | 1 |
| 0255 01 0013 | 13 mm / Single Ended Open Jaw Wrench Super Insulated | 1 |
| 0255 01 0014 | 14 mm / Single Ended Open Jaw Wrench Super Insulated | 1 |
| 0255 01 0017 | 17 mm / Single Ended Open Jaw Wrench Super Insulated | 1 |
| 0255 01 0019 | 19mm / Single Ended Open Jaw Wrench Super Insulated | 1 |
| 0255 01 0022 | 22 mm / Single Ended Open Jaw Wrench Super Insulated | 1 |
| 0255 01 0024 | 24 mm / Single Ended Open Jaw Wrench Super Insulated | 1 |
| 0435 03 0010 | 10 mm / Single Ended Ring Wrench Super Insulated | 1 |
| 0435 03 0011 | 11 mm / Single Ended Ring Wrench Super Insulated | 1 |
| 0435 03 0012 | 12 mm / Single Ended Ring Wrench Super Insulated | 1 |
| 0435 03 0013 | 13 mm / Single Ended Ring Wrench Super Insulated | 1 |
| 0435 03 0014 | 14 mm / Single Ended Ring Wrench Super Insulated | 1 |
| 0435 03 0017 | 17 mm / Single Ended Ring Wrench Super Insulated | 1 |
| 0435 03 0019 | 19mm / Single Ended Ring Wrench Super Insulated | 1 |
| 0435 03 0022 | 22 mm / Single Ended Ring Wrench Super Insulated | 1 |
| 0435 03 0024 | 24 mm / Single Ended Ring Wrench Super Insulated | 1 |



| 2.Drawer | | Code 13000 005569 |
|--------------|--------------------------------------|---|
| CODE | CONTENTS |  |
| 13000 005148 | 1000V 1/2" 10mm Socket Wrech 6 Point | 1 |
| 13000 005149 | 1000V 1/2" 11mm Socket Wrech 6 Point | 1 |
| 13000 005150 | 1000V 1/2" 12mm Socket Wrech 6 Point | 1 |
| 13000 005151 | 1000V 1/2" 13mm Socket Wrech 6 Point | 1 |
| 13000 005152 | 1000V 1/2" 14mm Socket Wrech 6 Point | 1 |
| 13000 005153 | 1000V 1/2" 15mm Socket Wrech 6 Point | 1 |
| 13000 005154 | 1000V 1/2" 16mm Socket Wrech 6 Point | 1 |
| 13000 005155 | 1000V 1/2" 17m Socket Wrech 6 Point | 1 |
| 13000 005156 | 1000V 1/2" 19mm Socket Wrech 6 Point | 1 |
| 13000 005157 | 1000V 1/2" 22mm Socket Wrech 6 Point | 1 |
| 13000 005158 | 1000V 1/2" 24mm Socket Wrech 6 Point | 1 |
| 13000 005159 | 1000V 1/2" 27mm Socket Wrech 6 Point | 1 |
| 13000 005277 | 1000V 1/2" Ratchet Handle | 1 |
| 13000 005262 | 1000V 1/2" 75mm Extension Bar | 1 |
| 13000 005264 | 1000V 1/2" 260mm Extension Bar | 1 |
| 13000 005541 | 1000V 1/2" Sliding T Bar | 1 |



| 3.Drawer | | Code 13000 005570 |
|--------------|--|---|
| CODE | CONTENTS |  |
| 2400 11 6240 | 1000V Insulated Type Waterpump Pliers Universal 240 mm | 1 |
| 3020 12 6160 | 1000V Insulated Electrician Type Combination Pliers 160 mm | 1 |
| 3220 13 6180 | 1000V Insulated Electrician Type Nose Pliers 180 mm | 1 |
| 3700 16 6160 | 1000V Insulated Electrician Type Side Cutter 160 mm | 1 |
| 3715 16 6165 | 1000V Insulated Cable Cutter 165 mm | 1 |
| 13000 005519 | 1000V Insulated Electrician Type Multi Function Spring Wrench 200 mm | 1 |
| 0600 01 0010 | 1000V Insulated Electrician Type Adjustable Wrench 10" | 1 |
| 03753 50 026 | Insulated Mechanical Cable Stripper 0.2-6mm | 1 |



| 4.Drawer | | Code 13000 005571 |
|--------------|---|---|
| CODE | CONTENTS |  |
| 4140 17 2575 | 1000 Insulated Electrician Type Flat Screwdriver 2.5 x 75 | 1 |
| 4140 17 4100 | 1000V Insulated Electrician Type Flat Screwdriver 4 x 100 | 1 |
| 4140 17 5512 | 1000V Insulated Electrician Type Flat Screwdriver 5.5 x 126 | 1 |
| 4140 17 6515 | 1000V Insulated Electrician Type Flat Screwdriver 6.5 x 125 | 1 |
| 4145 18 0360 | 1000V Insulated Electrician Type Phillips Screwdriver 6.5 x 150 | 1 |
| 4145 18 4580 | 1000V Insulated Electrician Type Phillips Screwdriver 3 x 60 | 1 |
| 4145 18 6100 | 1000V Insulated Electrician Type Phillips Screwdriver 4.5 x 80 | 1 |
| 4773 19 0040 | 1000V Insulated Electrician Type Nut Spinner 6 x 100 | 1 |
| 4773 19 0050 | 1000V Insulated Electrician Type Nut Spinner 4mm | 1 |
| 4773 19 0055 | 1000V Insulated Electrician Type Nut Spinner 5mm | 1 |
| 4773 19 0060 | 1000V Insulated Electrician Type Nut Spinner 5.5 mm | 1 |
| 4773 19 0070 | 1000V Insulated Electrician Type Nut Spinner 6mm | 1 |
| 4773 19 0080 | 1000V Insulated Electrician Type Nut Spinner 7mm | 1 |
| 4773 19 0090 | 1000V Insulated Electrician Type Nut Spinner 8mm | 1 |
| 4773 19 0100 | 1000V Insulated Electrician Type Nut Spinner 9mm | 1 |
| 4773 19 0110 | 1000V Insulated Electrician Type Nut Spinner 10mm | 1 |
| 4773 19 0120 | 1000V Insulated Electrician Type Nut Spinner 11mm | 1 |
| 4773 19 0130 | 1000V Insulated Electrician Type Nut Spinner 12mm | 1 |
| 4773 19 0140 | 1000V Insulated Electrician Type Nut Spinner 13mm | 1 |
| 4783 19 6120 | 1000V Insulated Magnetic Bit Holder 14mm | 1 |
| 4800 00 8131 | 1000V Bit Set in Plastic Case | 31 |



Garage Series Workshop Trolley (5-6-7-8 Drawers)



● Ergonomic handle



● 9 durable ABS worktop with divisions



● Paper Roll Holder x1
● Bottle & Tins Holder x2
● Hanger x1



● 100% extendable telescopic slides



● Central locking system
● Handgrip lock system
● Antitilt system



● 2 swivel castors with brake
● 2 fixed castors
● Ø 125 mm



● High strength electrostatic powder coating



Size: 470x670x1010 mm
Made of sheet metal, Electrostatic paint

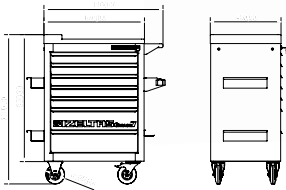

RAL 9005 GOF
RAL 3020 GOF

RAL 9005 GOF
RAL 5003 GOF

RAL 9005 GOF
RAL 7035 GOF

| CODE | DRAWERS | 400x548x68 | 400x548x143 | 400x548x218 | Kg | COLORS |
|-------------------------------|---------|------------|-------------|-------------|----|--------------|
| ★ 8242 32 1005 | 5 | 1X | 4X | -- | 59 | |
| ★ 8242 32 1006 | 6 | 4X | 1X | 1X | 62 | RAL 9005 GOF |
| ★ 8242 32 1007 | 7 | 5X | 2X | -- | 65 | RAL 3020 GOF |
| ★ 8242 32 1008 | 8 | 7X | 1X | -- | 67 | |
| ★ 8242 32 2005 | 5 | 1X | 4X | -- | 59 | |
| ★ 8242 32 2006 | 6 | 4X | 1X | 1X | 62 | RAL 9005 GOF |
| ★ 8242 32 2007 | 7 | 5X | 2X | -- | 65 | RAL 5003 GOF |
| ★ 8242 32 2008 | 8 | 7X | 1X | -- | 67 | |
| ★ 8242 32 3005 | 5 | 1X | 4X | -- | 59 | |
| ★ 8242 32 3006 | 6 | 4X | 1X | 1X | 62 | RAL 9005 GOF |
| ★ 8242 32 3007 | 7 | 5X | 2X | -- | 65 | RAL 7035 GOF |
| ★ 8242 32 3008 | 8 | 7X | 1X | -- | 67 | |
| ★ 8242 00 1142 Full 139Pcs | 7 | 5X | 2X | -- | | |
| ★ 8242 00 8142 Full 139Pcs | 8 | 7X | 1X | -- | | |

★ It is Limited by Stocks.



| 1.Drawer | | Code 8242001030 |
|----------|--|---|
| CODE | CONTENTS |  |
| 0130 | D/E Open Jaw Wrench Long Pattern 6x7 - 8x9 - 10x11 - 12x13 14x15 - 16x17 - 18x19 - 20x22 - 21x23 - 24x26 | 10 |
| 0330 | Combination Wrenches Long Pattern 6 - 7 - 8 - 9 - 10 - 11 - 12 - 13 - 14 - 17 - 19 - 22 | 12 |
| 0430 | Ring Wrench 6x7 - 8x9 - 10x11 - 12x13 - 14x15 - 16x17 - 18x19 - 20x22 | 8 |



| 2.Drawer | | Code 8242002072 |
|----------|--|---|
| CODE | CONTENTS |  |
| 1113 | Hexagonal Bits Socket H5-H6-H7-H8-H10-H12-H14 | 7 |
| 1113 | 1/2 Star Bits Socket T20-T25-T27-T30-T40-T45-T50-T55-T60 | 9 |
| 0330 | Combination Pliers Long 16-18 | 2 |
| 4900 | Hex Key Wrench Set 2-2.5-3-3.5-4-5-6-7-8-9-10-12 | 12 |
| 1107 | Socket Wrench Set 4 - 5 - 6 7 - 8 - 9 - 10 11 - 12 - 13 Six Points Ratchet Handle Universal Joint Sliding T Handle Extension Bar 50 -100 mm | 15 |
| 1113 | Socket Wrench Set 10 - 11 - 12 13 - 14 - 15 16 - 17 - 18 19 - 21 - 22 23 - 24 - 26 27 - 28 - 30 32 Six Points Ratchet Handle Universal Joint Sliding T Handle Adapter Extension Bar 125-250 mm | 24 |



3. Drawer

Code 8242003010

| CODE | CONTENTS |  |
|------|---------------------------------------|---|
| 3331 | Circlip Pliers Internal (Bent) 170 mm | 1 |
| 3321 | Circlip Pliers Internal (Flat) 180 mm | 1 |
| 3311 | Circlip Pliers External (Bent) 170 mm | 1 |
| 3301 | Circlip Pliers External (Flat) 180 mm | 1 |
| 3700 | Side Cutting Pliers 160 mm | 1 |
| 3220 | Nose Pliers (Flat) 200 mm | 1 |
| 3020 | Combination Pliers 180 mm | 1 |
| 2510 | Special 250 mm | 1 |
| 0600 | Adjustable Wrench 10" | 1 |
| 2400 | Waterpump Pliers Universal 240 mm | 1 |



4 .Drawer

Code 8242004018

| CODE | CONTENTS |  |
|------|--|---|
| 4300 | Screwdriver, Opak Flat 4x100-5x125-6x150-8x175 | 4 |
| 4320 | Screwdriver, Opak Philips 4.5x80-6x100 | 2 |
| 5800 | Machinist's Hammer 300 gr | 1 |
| 5850 | Plastic Hammer ø30 | 1 |
| 5545 | Drift Punch 5 mm | 1 |
| 5550 | Split Pin Punch 5 mm | 1 |
| 5540 | Center Punch 5x120 | 1 |
| 5500 | Flat Cold Chisel 150 mm | 1 |
| 4920 | Hex Key Wrench 3-4-5-6-7-8 | 6 |



5. Drawer

Code 8242005011

| CODE | CONTENTS |  |
|-------|----------------------------------|---|
| 07415 | Hand Brush 3 Raws | 1 |
| 6350 | Tyre Lever, Straight 400 mm | 1 |
| 6220 | Flexible Magnet Holder 500 gr | 1 |
| 4110 | Screwdriver Stubby Flat 6.5x25 | 1 |
| 4130 | Screwdriver Stubby Phillips 6x25 | 1 |
| 4770 | Nut Spinner 6-7-8-9-10-13 | 6 |





ELITE SERIES

Elite Series Workshop Trolley (7 Drawers)



- Ergonomic handle



- 9 durable ABS worktop with divisions



- Paper Roll Holder x1
● Bottle & Tins Holder x2
● Hanger x1



- 100% extendable telescopic slides



- Central locking, system handgrip lock system antitilt system



- 2 swivel castors with brake
● 2 fixed castors Ø 125 mm



- High strength electrostatic powder coating

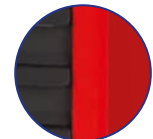

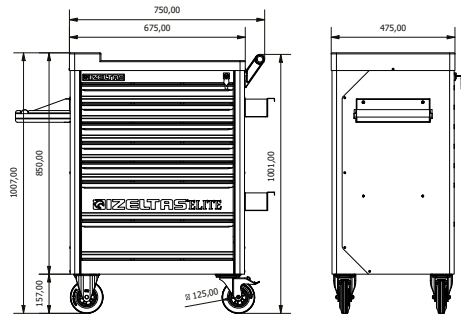

- 100% Extendable Telescopic Ball Bearing Rail with Tipping Safety System
- Central Lock System And Handgrip Lock System
- 1 Piece 4 Compartment Sturdy and Durable ABS Top Table
- 2 Pieces of Handyman
- 1 Piece Towel Holder
- 1 Piece Aluminum Handle
- 2 Fixed, 2 Movable Castors with Brake ø125 mm

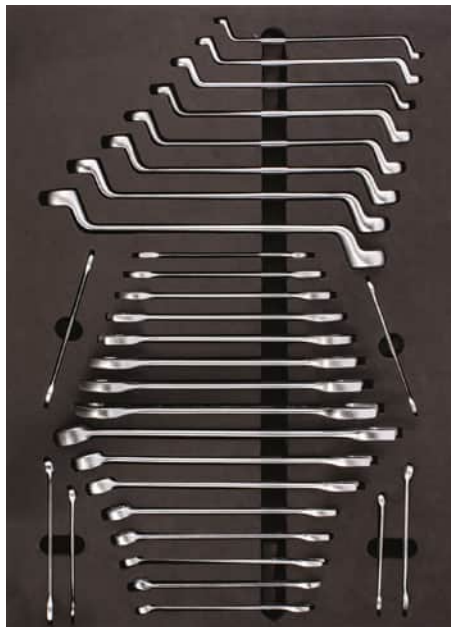

Size: 475x675x1007 mm
Made of sheet metal, Electrostatic paint

| CODE | DRAWERS | 35 kg | 35 kg | 35 kg | Kg | COLORS |
|------------------------------|---------|------------|-------------|-------------|----|--------------|
| 13000 005563 | 7 | 400x548x68 | 400x548x143 | 400x548x218 | 61 | RAL 9005 G0F |
| 13000 005572 Full 139 Pcs | 7 | 5X | 2X | - | - | RAL 3020 G0F |



| 1.Drawer | | Code 13000 005573 |
|----------|--|---|
| CODE | CONTENTS |  |
| 0130 | D/E Open Jaw Wrench Long Pattern 6x7 - 8x9 - 10x11 - 12x13 14x15 - 16x17 - 18x19 - 20x22 - 21x23 - 24x26 | 10 |
| 0330 | Combination Wrenches Long Pattern 6 - 7 - 8 - 9 - 10 - 11 - 12 - 13 - 14 - 17 - 19 - 22 | 12 |
| 0430 | Ring Wrench 6x7 - 8x9 - 10x11 - 12x13 - 14x15 - 16x17 - 18x19 - 20x22 | 8 |

| 2.Drawer | | Code 13000 005574 |
|----------|--|---|
| CODE | CONTENTS |  |
| 1113 | Hexagonal Bits Socket H5-H6-H7-H8-H10-H12-H14 | 7 |
| 1113 | / 1/2 Star Bits Socket T20-T25-T27-T30-T40-T45-T50-T55-T60 | 9 |
| 0330 | Combination Pliers Long 16-18 | 2 |
| 4900 | Hex Key Wrench Set 2-2.5-3-3.5-4-5-6-7-8-9-10-12 | 12 |
| 1107 | 1/4" Socket Wrench Set 4 - 5 - 6 7 - 8 - 9 - 10 11 - 12 - 13 Six Points 1/4" Ratchet Handle 1/4" Universal Joint 1/4" Sliding T Handle 1/4" Extension Bar 50 -100 mm | 15 |
| 1113 | Socket Wrench Set 10 - 11 - 12 13 - 14 - 15 16 - 17 - 18 19 - 21 - 22 23 - 24 - 26 27 - 28 - 30 32 Six Points Ratchet Handle Universal Joint Sliding T Handle Adapter Extension Bar 125-250 mm | 24 |





| 3.Drawer | | Code 13000 005575 |
|----------|---------------------------------------|---|
| CODE | CONTENTS |  |
| 3331 | Circlip Pliers Internal (Bent) 170 mm | 1 |
| 3321 | Circlip Pliers Internal (Flat) 180 mm | 1 |
| 3311 | Circlip Pliers External (Bent) 170 mm | 1 |
| 3301 | Circlip Pliers External (Flat) 180 mm | 1 |
| 3700 | Side Cutting Pliers 160 mm | 1 |
| 3220 | Nose Pliers (Flat) 200 mm | 1 |
| 3020 | Combination Pliers 180 mm | 1 |
| 2510 | Special 250 mm | 1 |
| 0600 | Adjustable Wrench 10" | 1 |
| 2400 | Waterpump Pliers Universal 240 mm | 1 |



| 4.Drawer | | Code 13000 005576 |
|----------|--|---|
| CODE | CONTENTS |  |
| 4300 | Screwdriver, Opak Flat 4x100-5x125-6x150-8x175 | 4 |
| 4320 | Screwdriver, Opak Philips 4.5x80-6x100 | 2 |
| 5800 | Machinist's Hammer 300 gr | 1 |
| 5850 | Plastic Hammer ø30 | 1 |
| 5545 | Drift Punch 5 mm | 1 |
| 5550 | Split Pin Punch 5 mm | 1 |
| 5540 | Center Punch 5x120 | 1 |
| 5500 | Flat Cold Chisel 150 mm | 1 |
| 4920 | Hex Key Wrench 3-4-5-6-7-8 | 6 |



| 5.Drawer | | Code 13000 005577 |
|----------|----------------------------------|---|
| CODE | CONTENTS |  |
| 07415 | Hand Brush 3 Raws | 1 |
| 6350 | Tyre Lever, Straight 400 mm | 1 |
| 6220 | Flexible Magnet Holder 500 gr | 1 |
| 4110 | Screwdriver Stubby Flat 6.5x25 | 1 |
| 4130 | Screwdriver Stubby Phillips 6x25 | 1 |
| 4770 | Nut Spinner 6-7-8-9-10-13 | 6 |



Partner Series Workshop Trolley Top Unit With 3 Drawers

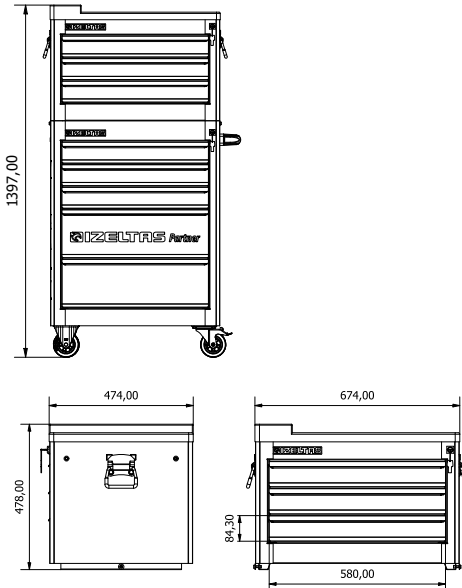

- Telescopic Slides Which Are %100 Extendable
- Central Lock System And Handgrip Lock System
- Durable ABS Worktop With 9 Divisions

Size: 474x674x478 mm
Made of sheet metal, Electrostatic paint

| CODE | DRAWERS |  35 kg |  Kg | COLORS |
|------|---------|---|--|--------|
| | | 400x548x74 | | |

13000 005561

3

3X

32.40

RAL 3020 GOF

8235

PARTNER SERIES

Partner Workshop Trolley (5 Drawers)



● Central lock system and handgrip lock system



● Telescopic slides which are %100 extendable.



● 9 Durable ABS worktop with divisions



● 2 swivel castors with brake
2 fixed castors ø100 mm



● High strength electrostatic powder coating



İZELTAS YOUTUBE

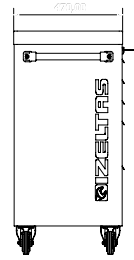
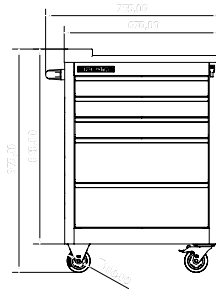

RAL 3020 GOF



RAL 5003 GOF



RAL 9005 GOF

Size: 470x670x975 mm
Made of sheet metal, Electrostatic paint

| CODE | DRAWERS | 3.5 kg | 3.5 kg | Kg | COLORS |
|------------------------------|---------|------------|-------------|----|--------|
| | | 397x549x74 | 397x549x182 | | |
| 8235 32 6005 | 5 | 3X | 2X | 56 | |
| 8235 32 5005 | 5 | 3X | 2X | 56 | |
| 8235 32 7005 | 5 | 3X | 2X | 56 | |
| 8235 00 6121 118 Full Pcs | 5 | 3X | 2X | | |



| CODE | CONTENTS | |
|------|---|----|
| | 1/4" Socket Wrench Set | |
| | Ratchet Handle | |
| 1107 | 4 - 5 - 6 7 - 8 - 9 - 10 11 - 12 - 13 Six Points | 15 |
| | Universal Joint | |
| | Sliding T Handle | |
| | Extention Bar 50-100 mm | |
| | 1/2" Socket Set | |
| | Ratchet Handle | |
| 1113 | 10 - 11 - 12 13 - 14 - 15 16 - 17 - 18 19 - 21 - 22 23 - 24 - 26 27 - 28 - 30 - 32 | 24 |
| | Universal Joint | |
| | Sliding T Handle Adapter | |
| | Extention Bar 125-250 mm | |
| 1507 | Spindle Handle | 1 |
| 4900 | Hex Key Wrench Set 2-2.5-3-3.5-4-5-6-7-8-9-10-12 mm | 12 |
| 4910 | Torx Key Wrench T9-T10-T15-T20-T25-T27-T30-T40 | 8 |
| 1108 | Deep Socket Wrench 6 Point 10-13-16-17-18-19 mm | 6 |
| 1113 | Spark Plug Socket With Rubber | 1 |
| 2400 | Waterpump Pliers, Universal | 1 |
| 2500 | Universal Grip | 1 |



2. Drawer

Code 8235002031

| CODE | CONTENTS | |
|------|---|----|
| 0100 | Double Ended Open Jaw Wrench Short Pattern 6x7 - 8x9 - 10x11 - 12x13 14x15 - 16x17 - 18x19 - 20x22 21x23 - 24x26 - 25x28 - 30x32 | 12 |
| 0320 | Combination Wrench Short Pattern 8 - 9 - 10 - 11 - 12 - 13 14 - 15 - 16 - 17 - 19 - 22 | 12 |
| 0430 | Ring Wrench 8x9 - 10x11 - 12x13 - 14x15 - 16x17 18x19 - 20x22 | 7 |



3. Drawer

Code 8235003017

| CODE | CONTENTS | |
|------|---|---|
| 4300 | Screwdriver, Opak Flat 3x80-4x80-4x100-5x125-6x150 | 5 |
| 4320 | Screwdriver, Opak Philips 4.5x80-6x100 | 2 |
| 3700 | Side Cutting Pliers 160 mm | 1 |
| 3020 | Combination Pliers 180 mm | 1 |
| 3220 | Nose Pliers Flat 200 mm | 1 |
| 4770 | Nut Spinner 6-7-8-10-13 | 5 |
| 5500 | Flat Cold Chisel 150 mm | 1 |
| 5800 | Machinist's Hammer 500 gr | 1 |



Eco Series Workshop Trolley (3-5-7 Drawers)

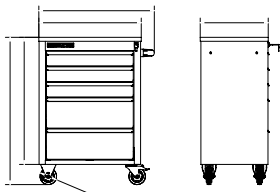

IZELTAS YOUTUBE

Made of sheet metal, Electrostatic paint



● Central locking



● %100 extendable telescopic slides

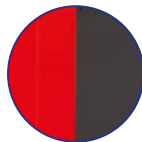

● High strength electrostatic powder coating









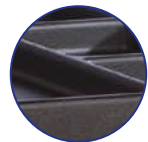



● Handle with anodised aluminum



● 2 swivel castors with brake
2 fixed castors ø 100 mm



● Resistant and solid top cover with 4 divisions

| CODE | DRAWERS |  35 kg |  35 kg | DISASSEMBLED SHELF |  Kg | COLORS |
|-------------------------------|---------|---|---|--------------------|--|---|
| | | 350x503x82 | 350x503x176 | | | |
| ★ 8243 32 1003 | 3 | 3X | -- | | 44.1 |  |
| ★ 8243 32 1005 | 5 | 3X | 2X | -- | 46.1 |  |
| ★ 8243 32 1007 | | 7X | -- | -- | 51.9 | |
| ★ 8243 32 2005 | 5 | 3X | 2X | -- | 46.1 |  |
| ★ 8243 32 2007 | | 7X | -- | -- | 51.9 |  |
| ★ 8243 32 3005 | 5 | 3X | 2X | -- | 46.1 |  |
| ★ 8243 32 3007 | | 7X | -- | -- | 51.9 |  |
| ★ 8243 00 1096 Full 93 Pcs | 5 | 3X | 2X | -- | |  |
| ★ 8243 00 7096 Full 93 Pcs | | 7X | -- | -- | |  |



1. Drawer Code 8243001030

| CODE | CONTENTS | ☐ |
|------|----------|---|
|------|----------|---|

| | | |
|------|---|----|
| 0100 | D/E Open Jaw Wrench Short Pattern 6x7 - 8x9 - 10x11 - 12x13 14x15 - 16x17 - 18x19 - 20x22 - 21x23 - 24x26 | 10 |
| 0320 | Combination Wrench Short Pattern 8 - 9 - 10 - 11 - 12 - 13 - 14 - 15 - 16 - 17 - 19 - 22 | 12 |
| 0430 | Ring Wrench 6x7 - 8x9 - 10x11 - 12x13 - 14x15 - 16x17 18x19 - 20x22 | 8 |



2. Drawer Code 8243002052

| CODE | CONTENTS | ☐ |
|------|----------|---|
|------|----------|---|

| | | |
|------|--|----|
| 1113 | Socket Wrench Set 1/2" mm 10 - 11 - 12 - 13 - 14 - 15 - 17 - 19 22 - 24 - 27 - 30 - 32 250 - 250 - 70 | 17 |
| | Sliding T Handle Adapte | |
| 1107 | Socket Wrench Set 1/4" mm 4 - 5 - 6 - 7 - 8 - 9 - 10 - 11 - 12 - 13 140 - 115 - 100 - 50 - 38 | 15 |
| 4900 | Hex Key Wrench Set 2 - 2.5 - 3 - 3.5 - 4 - 5 - 6 - 7 - 8 - 9 - 10 - 12 | 12 |
| 4770 | Nutspinners 6 - 7 - 8 - 10 - 13 | 5 |



3. Drawer Code 8243003013

| CODE | CONTENTS | ☐ |
|------|----------|---|
|------|----------|---|

| | | |
|------|---|---|
| 4320 | Opak Screwdriver, Phillips 4,5x80-6x100 | 2 |
| 4300 | Opak Screwdriver, Flat 4x100-5x125-6x150-8x175 | 4 |
| 3700 | Side Cutting Pliers 160 mm | 1 |
| 3020 | Combination Pliers 180 mm | 1 |
| 3220 | Nose Pliers, Flat 160 mm | 1 |
| 5500 | Flat Cold Chisel 150 mm | 1 |
| 5800 | Machinist's Hammer 300 gr | 1 |
| 2510 | Special Grip 250 mm | 1 |
| 2400 | Waterpump Pliers Universal 240 mm | 1 |



● Resistant and solid top cover with 4 divisions



● %100 extendable telescopic slides



● Central locking



● 2 swivel castors with brake
2 fixed castors ø 100 mm



● High strength electrostatic powder coating





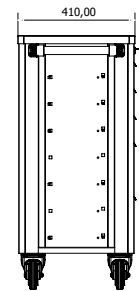
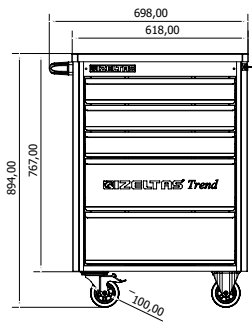

Size: 410x618x894 mm

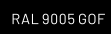

İZELTAS YOUTUBE

Made of sheet metal, Electrostatic paint

| CODE | DRAWERS |  25 kg 350x503x82 |  25 kg 350x503x176 |  Kg | COLORS |
|-----------------------------|---------|---|--|--|---|
| 13000 005562 | 3 | 3X | -- | 38.2 | |
| 8244 32 1005 | 5 | 3X | 2X | 40.7 | |
| 8244 32 1007 | 7 | 7X | -- | 44.4 | |
| 8244 00 5096 Full 93 Pcs | 5 | 3X | 2X | |  |
| 8244 00 7096 Full 93 Pcs | 7 | 7X | -- | |  |



1. Drawer Code 8244001030

| CODE | CONTENTS |  |
|------|---|---|
| 0100 | D/E Open Jaw Wrench Short Pattern 8x7 - 8x9 - 10x11 - 12x13 14x15 - 16x17 - 18x19 - 20x22 - 21x23 - 24x26 | 10 |
| 0320 | Combination Wrench Short Pattern 8 - 9 - 10 - 11 - 12 - 13 - 14 - 15 - 16 - 17 - 19 - 22 | 12 |
| 0430 | Ring Wrench 6x7 - 8x9 - 10x11 - 12x13 - 14x15 - 16x17 18x19 - 20x22 | 8 |



2. Drawer Code 8244002052

| CODE | CONTENTS |  |
|------|---|---|
| 1113 | Socket Wrench Set 1/2" mm 10 - 11 - 12 - 13 - 14 - 15 - 17 - 19 22 - 24 - 27 - 30 - 32 250 - 250 - 70 Sliding T Handle Adapte | 17 |
| 1107 | Socket Wrench Set 1/4" mm 4 - 5 - 6 - 7 - 8 - 9 - 10 - 11 - 12 - 13 140 - 115 - 100 - 50 - 38 | 15 |
| 4900 | Hex Key Wrench Set 2 - 2.5 - 3 - 3.5 - 4 - 5 - 6 - 7 - 8 - 9 - 10 - 12 | 12 |
| 4770 | Nutspinners 6 - 7 - 8 - 10 - 13 | 5 |



3. Drawer Code 8244003013

| CODE | CONTENTS |  |
|------|---|---|
| 4320 | Opak Screwdriver, Phillips 4.5x80-6x100 | 2 |
| 4300 | Opak Screwdriver, Flat 4x100-5x125-6x150-8x175 | 4 |
| 3700 | Side Cutting Pliers 160 mm | 1 |
| 3020 | Combination Pliers 180 mm | 1 |
| 3220 | Nose Pliers, Flat 160 mm | 1 |
| 5500 | Flat Cold Chisel 150 mm | 1 |
| 5800 | Machinist Hammer 300 gr | 1 |
| 2510 | Special Grip 250 mm | 1 |
| 2400 | Waterpump Pliers Universal 240 mm | 1 |

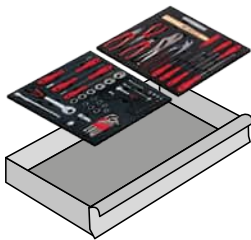

Size: 470x1224x964 mm

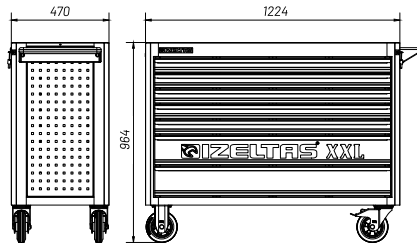

Each drawer can fit Two (2) of these tool inserts.

- 1.Premium Series Drawer Code 8245001042
- 2.Premium Series Drawer Code 8245002094
- 3.Premium Series Drawer Code 8245003014
- 14.Premium Series Drawer Code 8245004043
- 5.Premium Series Drawer Code 8245005043
- 6.Premium Series Drawer Code 8245006009
- 1.Pro Series Drawer Code 8241001030
- 2.Pro Series Drawer Code 8241002072
- 3.Pro Series Drawer Code 8241003051
- 4.Pro Series Drawer Code 8241004027
- 5.Pro Series Drawer Code 8241005010
- 6.Pro Series Drawer Code 8241006018
- 1. Elite Series Drawer Code 13000 005573
- 2. Elite Series Drawer Code 13000 005574
- 3.Elite Series Drawer Code 13000 005575
- 4. Elite Series Drawer Code 13000 005576
- 5.Elite Series Drawer Code 13000 005577
- 1.Partner Series Drawer Code 8235001072
- 2.Partner Series Drawer Code 8235002031
- 3.Partner Series Drawer Code 8235003017

● 18 mm solid wood top



● %100 extendable telescopic slides



● Central lock
● Handgrip Lock system
● Anti tilt system



● Ergonomic handle





● 2 swivel castors with brake
2 fixed castors ø 150mm

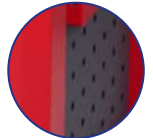

● High strength electrostatic powder coating.



Made of sheet metal, Electrostatic paint

| CODE | DRAWERS |  |  |  | COLORS |
|--------------|---------|---|---|---|------------------------------|
| 8246 32 1007 | 7 | 1098x400x60 | 1098x400x135 | 125.7 | RAL 9005 GOF RAL 3020 GOF |

8246 32 1007

7

5X

2X

125.7

RAL 9005 GOF

RAL 3020 GOF

8247 32 1007

Workbench Series Workshop Trolley (7 Drawers)

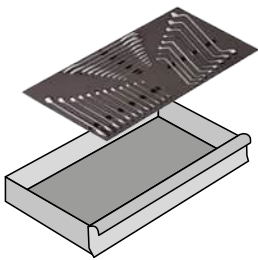

Size: 500x1150x991 mm

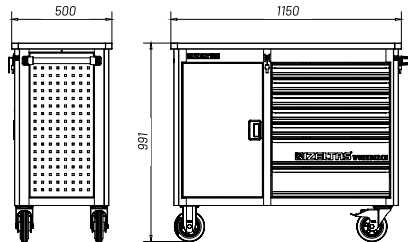

Each drawer can fit One (1) of these tool inserts.

- 1.Premium Series Drawer
- 2.Premium Series Drawer
- 3.Premium Series Drawer
- 14.Premium Series Drawer
- 5.Premium Series Drawer
- 6.Premium Series Drawer
- 1.Pro Series Drawer
- 2.Pro Series Drawer
- 3.Pro Series Drawer
- 4.Pro Series Drawer
- 5.Pro Series Drawer
- 6.Pro Series Drawer
- 1. Elite Series Drawer
- 2. Elite Series Drawer
- 3.Elite Series Drawer
- 4. Elite Series Drawer
- 5.Elite Series Drawer
- 1.Partner Series Drawer
- 2.Partner Series Drawer
- 3.Partner Series Drawer

- Code 8245001042
- Code 8245002094
- Code 8245003014
- Code 8245004043
- Code 8245005043
- Code 8245006009
- Code 8241001030
- Code 8241002072
- Code 8241003051
- Code 8241004027
- Code 8241005010
- Code 8241006018
- Code 13000 005573
- Code 13000 005574
- Code 13000 005575
- Code 13000 005576
- Code 13000 005577
- Code 8235001072
- Code 8235002031
- Code 8235003017

● 30 mm solid wood top

● %100 extendable telescopic slides

● Central lock
● Handgrip Lock system
● Anti tilt system

● Standard handle

● 2 swivel castors with brake
2 fixed castors ø 150mm

● High strength electrostatic powder coating

● 4 Short, 2 long separators

Made of sheet metal, Electrostatic paint

| CODE | DRAWERS | 35 kg | 35 kg | | COLORS |
|--------------|---------|------------|-------------|-------|------------------------------|
| 8247 32 1007 | 7 | 400x548x60 | 400x548x134 | 102.7 | RAL 9005 GOF RAL 3020 GOF |

8247 32 1007

7

5X

2X

102.7

RAL 9005 GOF

RAL 3020 GOF



Premium

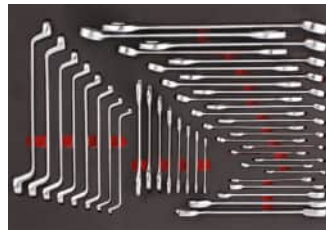
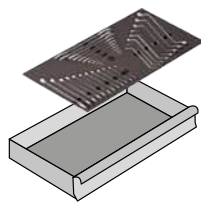

1.Drawer

Code 8245001042

Page 14



Pro

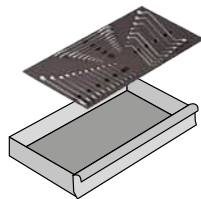

2.Drawer

Code 8245002094

Page 14



Elite

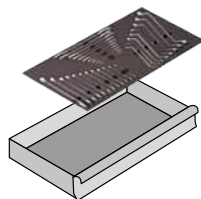

3.Drawer

Code 8245003014

Page 14



Partner

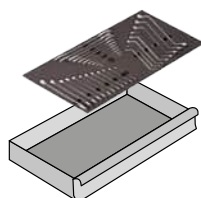

4.Drawer

Code 8245004043

Page 15



Workbench

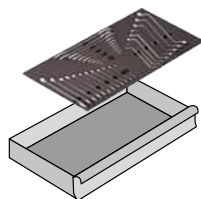

5.Drawer

Code 8245005043

Page 15



XXL

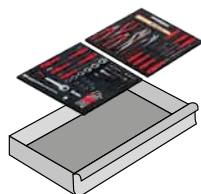

6.Drawer

Code 8245006009

Page 15

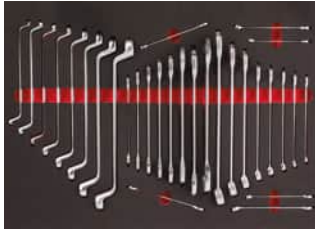

Drawer 1
Pro Series
 Code 8241001030
 Page 18

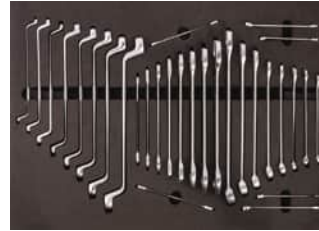

Drawer 1
Elite Series
 Code 13000 005573
 Page 30



Drawer 2
Pro Series
 Code 8241002072
 Page 18



Drawer 2
Elite Series
 Code 13000 005574
 Page 30



Drawer 3
Pro Series
 Code 8241003051
 Page 18



Drawer 3
Elite Series
 Code 13000 005575
 Page 31

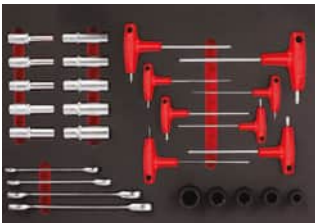

Drawer 4
Pro Series
 Code 8241004027
 Page 18



Drawer 4
Elite Series
 Code 13000 005576
 Page 31



Drawer 5
Pro Series
 Code 8241005010
 Page 19



Drawer 5
Elite Series
 Code 13000 005577
 Page 31



Drawer 6
Pro Series
 Code 8241006018
 Page 19

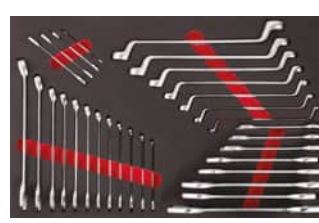

Drawer 2
Partner Series
 Code 8235002031
 Page 35



Drawer 1
Partner Series
 Code 8235001072
 Page 34



Drawer 3
Partner Series
 Code 8235003017
 Page 35

TROLLEY CONTENTS

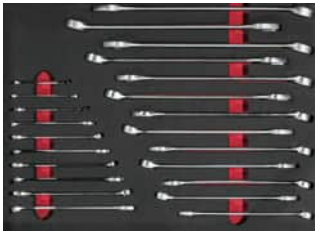

Grand Master Drawer 1- Left
Code 13000 005590
Page 7

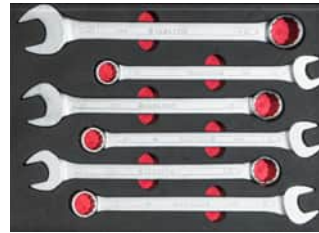

Grand Master Drawer 1 - Right
Code 13000 005589
Page 7

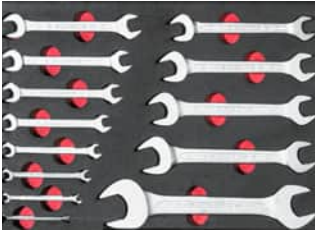

Grand Master Drawer 2- Left
Code 13000 005591
Page 7

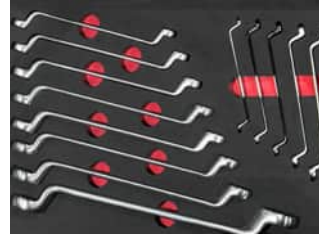

Grand Master Drawer 2 - Right
Code 13000 005592
Page 7



Grand Master Drawer 3-Left
Code 13000 005594
Page 8



Grand Master Drawer 3 - Right
Code 13000 005593
Page 8



Grand Master Drawer 4-Left
Code 13000 005595
Page 9

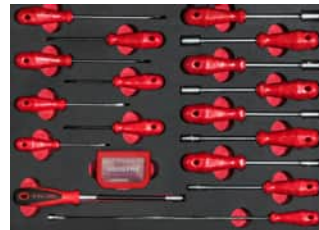

Grand Master Drawer 4 - Right
Code 13000 005596
Page 9



Grand Master Drawer 5-Left
Code 13000 005598
Page 10



Grand Master Drawer 5 - Right
Code 13000 005597
Page 10



Grand Master Drawer 6-Left
Code 13000 005600
Page 11



Grand Master Drawer 6 - Right
Code 13000 005599
Page 11



Wagon Series Workshop Trolley



● Durable ABS worktop with divisions



● Locked T-handle



● 2 swivel castors with brake 2 fixed castors
ø 125 mm



● High strength electrostatic powder coating



● 2x adaptable shelves with separator 10 pcs



● Standard handle



● 2X tin holder

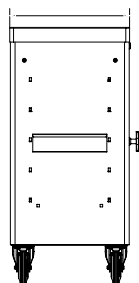
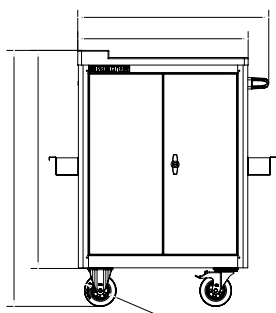

Made of sheet metal, Electrostatic paint

| CODE | SIZE (mm) | Kg | COLORS |
|------|-----------|----|--------|
|------|-----------|----|--------|

8210 32 6001

474x670x1020

45

RAL 9005 GOF
RAL 3020 GOF

8160 32 6001

Tool Cabinet



● Locked T-handle



● %100 extendable telescopic slides



● 4 swivel castors with brake ø 50 mm



● High strength electrostatic powder coating

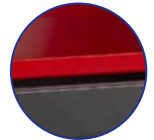

● Bottle and tins holder x2



● Hanger x4



● Special hanger x4



● Hanger for wrenches x1

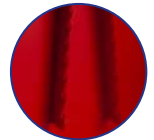

● Special tin holder x1



● Drill bits holder x1



Made of sheet metal, Electrostatic paint

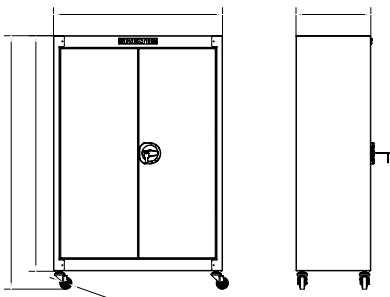

| CODE |  | SIZE (mm) |  Kg | COLORS |
|------|---|-----------|--|--------|
| | 228x567x58 | | | |

8160 32 6001

3x

310x700x1050

35

RAL 9005 GOF

RAL 3020 GOF



- 120 degree openable cover
- 10 kg shelf carrying capacity
- Single door, 2 shelves, 3 compartments
- Premium sheet metal construction
- High strength electrostatic powder coating
- 4 clothes hangers
- Padlockable locking mechanism
- Ventilation grilles
- Plastic leg that provide balance and do not scratch the floor
- Hidden hinge
- Impact resistant support sheets used on the side surfaces
- Easy to assemble together

RAL 9005 60F

RAL 7035 60F

Width 300 mm
Depth 400 mm
Height 1800 mm

CODE

SIZE (mm)



Kg

13000 00 5399 300x400x1800 24.20

Made of sheet metal, Electrostatic paint



13000 005400

Wide Locker



- 120 degree openable cover
- 10 kg shelf carrying capacity
- Single door, 2 shelves, 3 compartments
- Premium sheet metal construction
- High strength electrostatic powder coating
- 4 clothes hangers
- Padlockable locking mechanism
- Ventilation grilles
- Plastic leg that provide balance and do not scratch the floor
- Hidden hinge
- Impact resistant support sheets used on the side surfaces
- Easy to assemble together

RAL 9005 G0F

RAL 7035 G0F

Width 400 mm
Depth 400 mm
Height 1800 mm

| CODE | SIZE (mm) |  Kg |
|------|-----------|--|
|------|-----------|--|

13000 00 5400 400x400x1800 26.20

Made of sheet metal, Electrostatic paint

13000 005566

Medium Locker Thin

13000 005567

Medium Locker Wide



- 120 degree openable cover
- 10 kg shelf carrying capacity
- Single door, 1 shelves, 2 compartments
- Premium sheet metal construction
- High strength electrostatic powder coating

- Padlockable locking mechanism
- Ventilation grilles on up and down sides of the door
- Hidden hinge
- Easy to assemble together

RAL 9005 GOF
RAL 7035 GOF

Width 300 mm
Depth 400 mm
Height 900 mm

RAL 9005 GOF
RAL 7035 GOF

Width 400 mm
Depth 400 mm
Height 900 mm

Made of sheet metal, Electrostatic paint

Made of sheet metal, Electrostatic paint

| CODE | SIZE (mm) | Kg |
|------|-----------|----|
|------|-----------|----|

| CODE | SIZE (mm) | Kg |
|------|-----------|----|
|------|-----------|----|

13000 00 5566

300x400x900

12.5

13000 00 5567

400x400x900

13.2

Cube Locker Thin

Cube Locker Wide



- 120 degree openable cover
- Single door, 1 shelves
- Premium sheet metal construction
- High strength electrostatic powder coating
- Padlockable locking mechanism
- Ventilation grilles on up and down sides of the door
- Hidden hinge
- Easy to assemble together

RAL 9005 G0F
RAL 7035 G0F

Width 300 mm
Depth 400 mm
Height 450 mm

RAL 9005 G0F
RAL 7035 G0F

Width 400 mm
Depth 400 mm
Height 450 mm

Made of sheet metal, Electrostatic paint

Made of sheet metal, Electrostatic paint

| CODE | SIZE (mm) | Kg |
|------|-----------|----|
|------|-----------|----|

| CODE | SIZE (mm) | Kg |
|------|-----------|----|
|------|-----------|----|

13000 00 5564

300x400x450

6.15

13000 00 5565

400x400x450

7.10

Service Trolley With Drawers



2X Drawers, 35 kg Loading Capacity

Telescopic Slides Which Are %100 extendable, handgrip lock system

Central lock system

2X Fixed, 2x Swivel Castors with Brake

1X Demountable Shelf

2X Fixed Shelf, loading capacity per shelf 50 kg

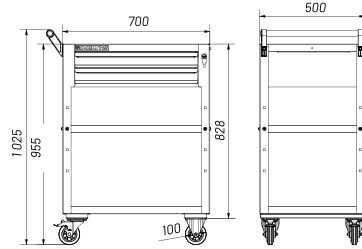

Steel construction

| CODE | SIZE (mm) | Kg | COLORS |
|--------------|-------------|-------|---|
| 13000 005560 | 500x700x955 | 31.10 | <div style="background-color: black; color: white; padding: 2px;">RAL 9005 GOF</div> <div style="background-color: red; color: white; padding: 2px;">RAL 3020 GOF</div> |

Disassembled Mini Service Trolley

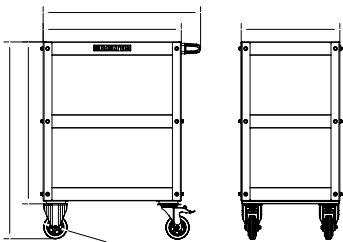

3X Rubber Anti Slipping Mats

2X Fixed, 2X Swivel Castors with Brake (ø 100 mm)

8550 34 8002

8550 34 8001

Steel construction

Robust sheet-steel construction, Loading capacity per shelf 50 Kg

| CODE | 50 kg | SIZE (mm) | Kg | COLORS |
|--------------|-------|-------------|----|---|
| 8550 34 8001 | 3X | 424x594x851 | 18 | <div style="background-color: black; color: white; padding: 2px;">RAL 9005 GOF</div> <div style="background-color: red; color: white; padding: 2px;">RAL 3020 GOF</div> |
| 8550 34 8002 | 3X | 424x594x851 | 23 | <div style="background-color: black; color: white; padding: 2px;">RAL 9005 GOF</div> <div style="background-color: red; color: white; padding: 2px;">RAL 3020 GOF</div> |

8545 34 1005

Platform Wagon

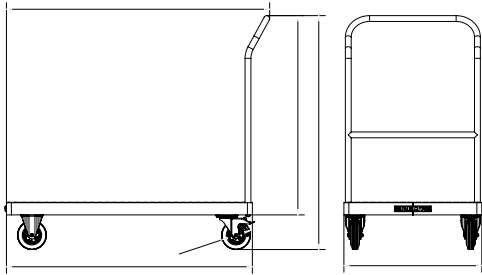

12mm PVC coated plywood

2X Fixed, 2X Swivel Castors with Brake (ø 125mm)

Robust sheet-steel construction, Loading capacity per shelf 310 Kg

Steel construction

| CODE | SIZE (mm) |  Kg | COLORS |
|------|-----------|--|--------|
|------|-----------|--|--------|

8545 34 1005

600x1145x1025

38

RAL 9005 GOF

8550 34 6001

Service Trolley (Large Size)

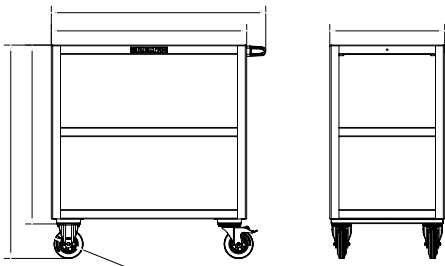

3X Rubber Anti Slipping Mats

2X Fixed, 2X Swivel Castors with Brake (ø 125 mm)

Robust sheet-steel construction, Loading capacity per shelf 75 Kg

Steel construction

| CODE |  | SIZE (mm) |  Kg | COLORS |
|------|---|-----------|--|--------|
|------|---|-----------|--|--------|

8550 34 6001

3X

500x850x935

37

RAL 3020 GOF

Work Bench (With Panel)



Central locking system, handgrip lock system

Robust welded design

100% extendable telescopic slides

High strength electrostatic powder paint

Perforated panel with electrical plugs 220 V

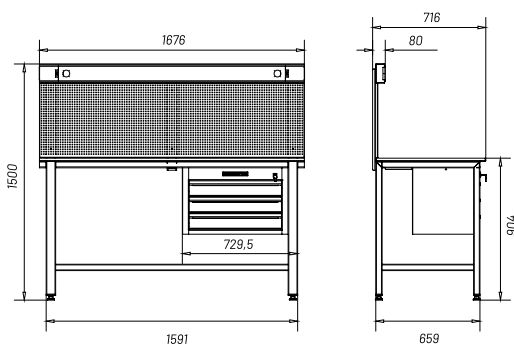

Strong and durable steel construction and Plywood bench

| CODE |  | SIZE (mm) |  Kg | COLORS |
|------|---|-----------|--|--------|
|------|---|-----------|--|--------|

8500 34 6001

3X

720x1680x1495

102

RAL 7016 GOF

RAL 3020 GOF

Work Bench (Without Panel)



Central locking system, handgrip lock system

Robust welded design

100% extendable telescopic slides

High strength electrostatic powder paint

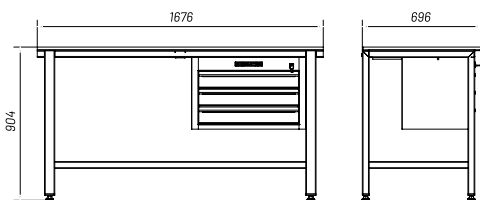

Strong and durable steel construction and Plywood bench

| CODE |  | SIZE (mm) |  Kg | COLORS |
|------|---|-----------|--|--------|
|------|---|-----------|--|--------|

8501 34 6001

3X

700x1680x900

84

RAL 7016 GOF

RAL 3020 GOF

Disassembled Workbench

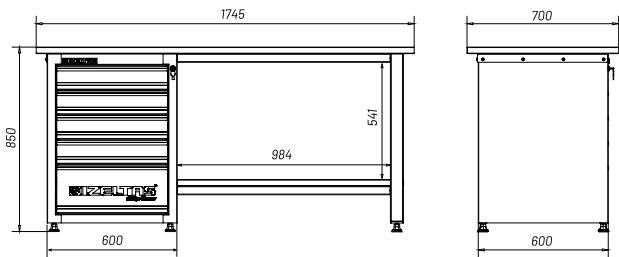

● %100 extendable telescopic slides



● Central lock
● Handgrip Lock system





Robust disassembled design

30 mm solid wood

Height adjustable feet

Steel construction

| CODE | DRAWERS |  35 kg |  35 kg |  Kg | COLORS |
|--------------|---------|---|---|--|--------|
| 8502 34 6002 | 5 | 4X | 1X | | |

| |
|--------------|
| RAL 7016 G0F |
| RAL 3020 G0F |



Tool Chest With Drawers

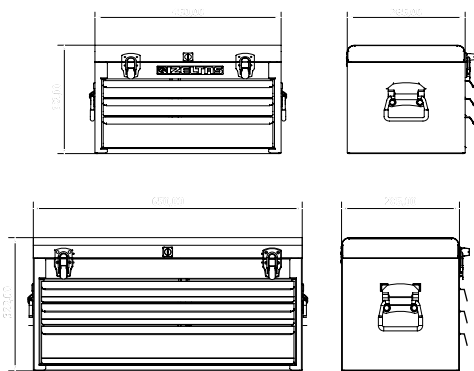

RAL 3020 G0F

Made from metal sheet, Electrostatic paint

| CODE | SIZE (mm) | DRAWERS | Tray Size (mm) | | Kg |
|--------------|-------------|---------|----------------|------------|----|
| | | | 2x | 1x | |
| 8320 33 1001 | 285x450x322 | 3X | 238x370x47 | 238x370x87 | 16 |
| 8320 33 1003 | 285x650x322 | 3X | 238x570x47 | 238x570x87 | 20 |

8410

Tool Box (3 Trays)

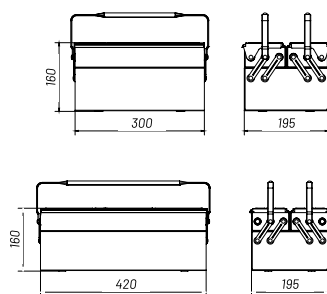

RAL 9005 GOF

RAL 3020 GOF

Made from metal sheet, Electrostatic paint

| CODE | SIZE (mm) | g | □ |
|--------------|-------------|------|---|
| 8410 33 6103 | 195x300x160 | 2400 | 1 |
| 8410 33 6203 | 195x420x160 | 3000 | 1 |

8420

Tool Box (5 Trays)

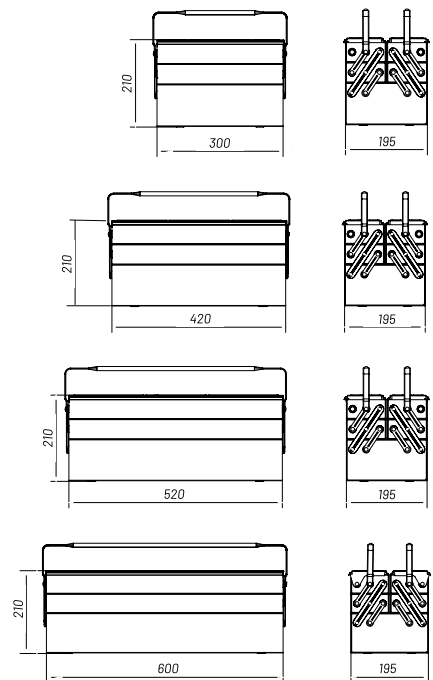

RAL 9005 GOF

RAL 3020 GOF

Made from metal sheet, Electrostatic paint

| CODE | SIZE (mm) | g | □ |
|--------------|-------------|------|---|
| 8420 33 6105 | 195x300x210 | 3200 | 1 |
| 8420 33 6205 | 195x420x210 | 4200 | 1 |
| 8420 33 6305 | 195x520x210 | 5000 | 1 |
| 8420 33 6405 | 195x600x210 | 5600 | 1 |

Tool Box (5 Trays)



8420 00 5063

Tool Box for Mechanician (62 Pcs, 5 Trays)



8420 00 5046

Tool Box for Electrician (45 Pcs, 5 Trays)





8420 00 5028

Tool Box for Plumbers (28 Pcs, 5 Trays)





8420 00 5063
Tool Box for Mechanician (5 Trays)

| CODE | SIZE mm |  |
|--------------|---------------------|---|
| 8420 00 5063 | 195x420x210 FULL | 62 |

| CODE | CONTENTS |  |
|--------------|--|---|
| 05881 50 015 | Chrom Case Steel, Measuring tapes | 1 |
| 4785 19 6330 | Screwdriver, Magnetic Bit Holder (Short) | 1 |
| 4800 00 8110 | Bits Set 10 (Pcs) 25 mm | 10 |
| 4320 | Screwdriver, Opak, Flat 4.5x80-6x100 | 2 |
| 4300 | Screwdriver, Opak, Philips 3x80-4x100-5x125-6x150 | 4 |
| 4550 17 0135 | Voltage Tester 135mm | 1 |
| 2400 11 0240 | Water Pump Pliers Universal 240mm | 1 |
| 1113 | Socket Wrench 10-11-12-13-14-15-17-19-22-24-27-30-32 | 13 |
| 1513 06 4250 | Extension Bar Long 250 mm | 1 |
| 1513 06 4070 | Universal Joint 70 mm | 1 |
| 1513 06 0032 | Ratchet Handle 250 mm | 1 |
| 4900 00 3112 | Hex Key Wrench Set 2-2.5-3-3.5-4-5-6-7-8-9-10-12 | 12 |
| 0320 | Combination Wrench Short Pattern 8-9-10-11-12-13-14-17-19-22 | 10 |
| 3700 16 2160 | Side Cuting Nippers, Opak insulated | 1 |
| 3020 12 2180 | 180mm Combination Pliers, Opak Insulated | 1 |
| 3220 13 2160 | 160mm Nose Pliers, Flat, Opak Insulated | 1 |

8420 00 5046
Tool Box for Electrician (5 Trays)

| CODE | SIZE mm |  |
|--------------|---------------------|---|
| 8420 00 5046 | 195x420x210 FULL | 45 |

| CODE | CONTENTS |  |
|--------------|---|---|
| 05881 50 005 | Plastic Measuring Tape | 1 |
| 4783 19 6120 | Screwdriver, Magnetic Bit Holder Insulated 6.3x120 | 1 |
| 4800 00 8106 | Bits Set (6 Pcs) | 6 |
| 0600 01 1010 | Adjustable Jaw Wrench | 1 |
| 4140-4145 | Insulated Electrician type Flat Screwdriver, Phillis 1000V 4x100-5.5x125 - 4.5x80-6x100 | 4 |
| 4550 17 0135 | Voltage Tester 135mm | 1 |
| 4550 17 0190 | Voltage Tester 190mm | 1 |
| 4773 | Nut Spinner, Electrician Blade Insulated 1000V 6-7-8-10-13 | 5 |
| 0340 | Combination Wrench With Ratchet 8-10-12-13-17-19 | 6 |
| 4900 00 3110 | Hex Key Wrench Set 10 pcs 2-2.5-3-4-5-6-7-8-9-10 | 10 |
| 4500-4520 | Screwdriver, Electronic 3x80-3x100-3x125-3x60-4x80 | 5 |
| 3700 16 6160 | Insulated Electrician Type Side Cutter 1000V | 1 |
| 3020 12 6180 | Insulated Electrician Type Combination Plier 1000V | 1 |
| 3220 13 6160 | Insulated Electrician Type Nose Plier 1000V | 1 |

8420 00 5028
Tool Box for Plumbers (5 Trays)

| CODE | SIZE mm |  |
|--------------|---------------------|---|
| 8420 00 5028 | 195x420x210 FULL | 28 |

| CODE | CONTENTS |  |
|--------------|---|---|
| 0600 01 1010 | 10" Adjustable Wrench | 1 |
| 0600 01 1012 | 12" Adjustable Jaw Wrench PVC Insulated | 1 |
| 2400 11 0240 | 240 Waterpump Pliers, Universal | 1 |
| 2100 10 0012 | 12" Pipe Wrench, Stillson | 1 |
| 4901 22 1270 | 1/2" Hex Key Wrench SAE | 1 |
| 4300 17 6150 | Screwdriver, Opak, Slotted 6x150 | 1 |
| 4320 18 6100 | Screwdriver, Opak, Phillips 6x100 | 1 |
| 5800 25 0500 | Machinist Hammer | 1 |
| 5500 23 0200 | 200 mm Flat Cold Chiesel | 1 |
| 3830 15 0250 | 250 mm Tower Pincers | 1 |
| 4900 00 3112 | Hex Key Wrench Set 12 pcs 2-2.5-3-3.5-4-5-6-7-8-9-10-12 | 12 |
| 0588 15 0015 | Chrom Case Steel Measuring Tape | 1 |
| 2201 10 0010 | 1" Pipe Wrench | 1 |
| 3700 16 2160 | 160mm Side Cutting Nippers, Opak insulated | 1 |
| 3020 12 2180 | Combination Pliers, Opak Insulated | 1 |
| 3220 13 2160 | 160mm Nose Pliers, Flat, Opak Insulated | 1 |

8440

Plastic Tool Boxes



| CODE | inch | SIZE mm | g | |
|--------------|------|-------------|------|---|
| 8440 33 1016 | 16" | 413x212x186 | 1207 | 4 |
| 8440 33 1019 | 19" | 480x267x242 | 1922 | 4 |
| 8440 33 1022 | 22" | 564x310x310 | 2870 | 4 |

8445 33 1028

Plastic Mobile Tool Chest



| CODE | inch | SIZE mm | g | |
|--------------|------|-------------|------|---|
| 8445 33 1028 | 28" | 380x595x420 | 5900 | 1 |

8705 00 6113

Hobby Set Auto Type (13 pcs)



| CODE | CONTENTS | |
|------|--|---|
| 0100 | Duble Ended Open Jaw Wrench.Short Pattern 8x9-10x11-12x13-14x15-16x17-18x19 | 6 |
| 1841 | Single Ended Tubular Socket Wench | 1 |
| 2400 | Waterpump Pliers Universal | 1 |
| 3020 | Combination Pliers | 1 |
| 4240 | Screwdriver Set Reversible 4.5x80 - 6x80 | 2 |
| 5800 | Machinist Hammer | 1 |
| 6350 | Tyre Lever Straight | 1 |

8790 00 8106

Maintenance Set (5 Pcs)



| CODE | CONTENTS | |
|--------------|-----------------------------|---|
| 3020 12 3160 | Combination Pliers | 1 |
| 3220 13 3160 | Nose Pliers Flat | 1 |
| 3700 16 3140 | Side Cutting Pliers | 1 |
| 4100 17 5100 | Screwdriver Kraft, Flat | 1 |
| 4120 18 4580 | Screwdriver Kraft, Phillips | 1 |

8793 00 1014

Maintenance Set (14 Pcs)



| CODE | CONTENTS | |
|--------------|--|---|
| 0100 | Duble Ended Open Jaw Wrench Short Pattern 6x7-8x9-10x11-12x13-14x15-16x17-18x19-20x22 | 8 |
| 3220 13 2160 | Nose Pliers Flat | 1 |
| 3700 16 2140 | Side Cutting Pliers | 1 |
| 4300 | Screwdriver Kraft, Flat | 2 |
| 4320 | Screwdriver Kraft, Phillips | 2 |

8786 00 1003

Outdoor Set (3 Pcs)



SOHBETLER

| CODE | CONTENTS | |
|--------------|----------------|---|
| 6710 27 0230 | Pruning Shears | 1 |
| 6735 27 0300 | Pruning Saw | 1 |
| 6410 25 0800 | Hatchet | 1 |

8779 00 8741

Biker Set (42 Pcs)



| CODE | CONTENTS | |
|--------------|--|----|
| 0100 01 0809 | Double Ended Open Jaw Wrench Short Pattern | 1 |
| 0100 01 1011 | Double Ended Open Jaw Wrench Short Pattern | 1 |
| 0100 01 1213 | Double Ended Open Jaw Wrench Short Pattern | 1 |
| 0100 01 1415 | Double Ended Open Jaw Wrench Short Pattern | 1 |
| 0100 01 1617 | Double Ended Open Jaw Wrench Short Pattern | 1 |
| 0600 01 1008 | Adjustable Wrench | 1 |
| 1107 06 0006 | Socket Wrench 6 Point | 1 |
| 1107 06 0008 | Socket Wrench 6 Point | 1 |
| 1107 06 0010 | Socket Wrench 6 Point | 1 |
| 1107 06 0011 | Socket Wrench 6 Point | 1 |
| 1107 06 0012 | Socket Wrench 6 Point | 1 |
| 1107 06 0013 | Socket Wrench 6 Point | 1 |
| 1107 06 5010 | Bit Holder Socket | 1 |
| 4240 00 7102 | Screwdriver Set Reversible | 2 |
| 4800 00 8106 | Bit Set 6 Pcs | 6 |
| 4900 00 3110 | Hex Set Wrench Set (10 Pcs) | 10 |
| 4910 00 7108 | Torx Key Wrench Set (8 Pcs) | 8 |
| 1507 06 0050 | Extension Bar | 1 |
| 1507 06 2140 | Ratchet Wrench | 1 |
| 1507 06 4080 | Spindle Handle | 1 |

PLIERS CUTTER SCREWDRIVER

IZELTAS

BLACK LINE

NEW



13000 005133

| CODE | CONTENTS | <input type="checkbox"/> |
|--------------|------------------------------|--------------------------|
| 13000 005118 | Combination Pliers 180 mm | 1 |
| 13000 005117 | Long Nose Pliers Flat 180 mm | 1 |
| 13000 005119 | Side Cutter 160 mm | 1 |
| 13000 005116 | Screwdriver Flat 6x100 | 1 |
| 13000 005120 | Screwdriver Phillips 6x100 | 1 |

13000 005538

Electro Tool Bag (24 Pcs)



| CODE | CONTENTS | |
|--------------|---|---|
| 03752 50 625 | Cable Stripper | 1 |
| 05881 50 005 | Plastic Steel Case, Measuring tapes | 1 |
| 3020 12 6180 | Insulated Electrician Type Combination Pliers 1000V | 1 |
| 3220 13 6180 | Insulated Electrician Type Nose Pliers 1000V | 1 |
| 3700 16 6160 | Insulated Electrician Type Side Cutter 1000V | 1 |
| 4140 | Insulated Electrician Type Flat Screwdriver 1000V 2.5x75 - 4x100 - 5.5x125 | 3 |
| 4145 | Insulated Electrician Type Phillips Screwdriver 1000V 3x60 - 4.5x80 - 6x100 | 3 |
| 4550 17 0190 | Voltage Tester (Flat) | 1 |
| | Socket Wrench 6 Points 1000V (mm) 10 - 11 - 12 - 13 - 14 - 15 - 16 - 17 - 19 | 9 |
| 13000 005263 | Extension Bar 1000V | 1 |
| 13000 005277 | Ratchet Handle 1000V (32 Teeth) | 1 |

14000 004136

Tool Backpack



Tool Backpack

- Waterproof, solid, resistant and long-lasting 600X600 impertex fabric
- Protection provider, reinforced, solid plastic base
- Reflective front and interior pockets for maximum organization
- Laptop compartment, removable divider with pockets for frequently used tools
- Back support with soft pad
- Side bottle pockets

This backpack is sold empty

| Code | Size(mm) | g |
|--------------|-------------|------|
| 14000 004136 | 700x280x450 | 1385 |



Pro Tool Backpack

- *Waterproof, solid, resistant and long-lasting 600X600 impertex fabric*
- *Protection provider, reinforced, solid plastic base*
- *Reflective front and interior zip pockets for maximum organization*
- *Laptop compartment, removable divider with pockets for frequently used tools*
- *Back support with soft pad*
- *Side pockets*

This backpack is sold empty

| Code | Size(mm) |  g |
|--------------|-------------|--|
| 14000 005148 | 250x350x480 | 1220 |

14000 004133

Large Tool Bag



Large Tool Bag

- Waterproof, solid, resistant and long-lasting 600X600 impertex fabric
- Protection provider, reinforced, solid plastic base
- Reflective front pockets with multiple back and interior pockets for maximum organization
- Wide interior space with special tool compartment
- Easy carrying with adjustable shoulder strap



This toolbag is sold empty

| Code | Size(mm) | g |
|--------------|-------------|------|
| 14000 004133 | 250x350x480 | 1220 |

14000 004135

Medium Tool Bag



Medium Tool Bag

- Waterproof, solid, resistant and long-lasting 600X600 impertex fabric
- Protection provider, reinforced, solid plastic base
- Reflective front pockets with multiple back and interior pockets for maximum organization
- Wide interior space with special tool compartment
- Easy carrying with adjustable shoulder strap



This toolbag is sold empty

| Code | Size(mm) | g |
|--------------|-------------|-----|
| 14000 004135 | 290x230x360 | 870 |

Bag is sold empty

Small Tool Bag



Small Tool Bag

- Waterproof, solid, resistant and long-lasting 600X600 impertex fabric
- Reinforced base
- Zippered front pocket
- Buttoned back pocket
- Wide interior space with special tool compartment
- Leather grips for comfortable carrying
- Side reflectors



| Code | Size(mm) | g |
|--------------|-------------|-----|
| 14000 004134 | 120x230x300 | 390 |

Handyman Tool Belt



Handyman Tool Belt

- Waterproof, solid, resistant and long-lasting 600X600 impertex fabric
- Maximum organization providing functional model with 3 different sized pockets and 8 tool hangers
- Reflective front pocket
- Adjustable and functional solid belt

This tool belt is sold empty

| Code | Size(mm) | g |
|--------------|-------------|-----|
| 14000 004137 | 424x594x851 | 290 |



Product Code
14000005148

Product Code
14000004133

Product Code
14000004135

Product Code
14000004134

Product Code
14000004136

Product Code
14000004137

MANUFACTURING STEPS



BILLET



FINAL PRODUCT





WRENCHES

Open Jaw Wrenches

Combination Wrenches

Ring Wrenches

Slugging Wrenches

Adjustable Wrenches



DOUBLE ENDED OPEN JAW WRENCH

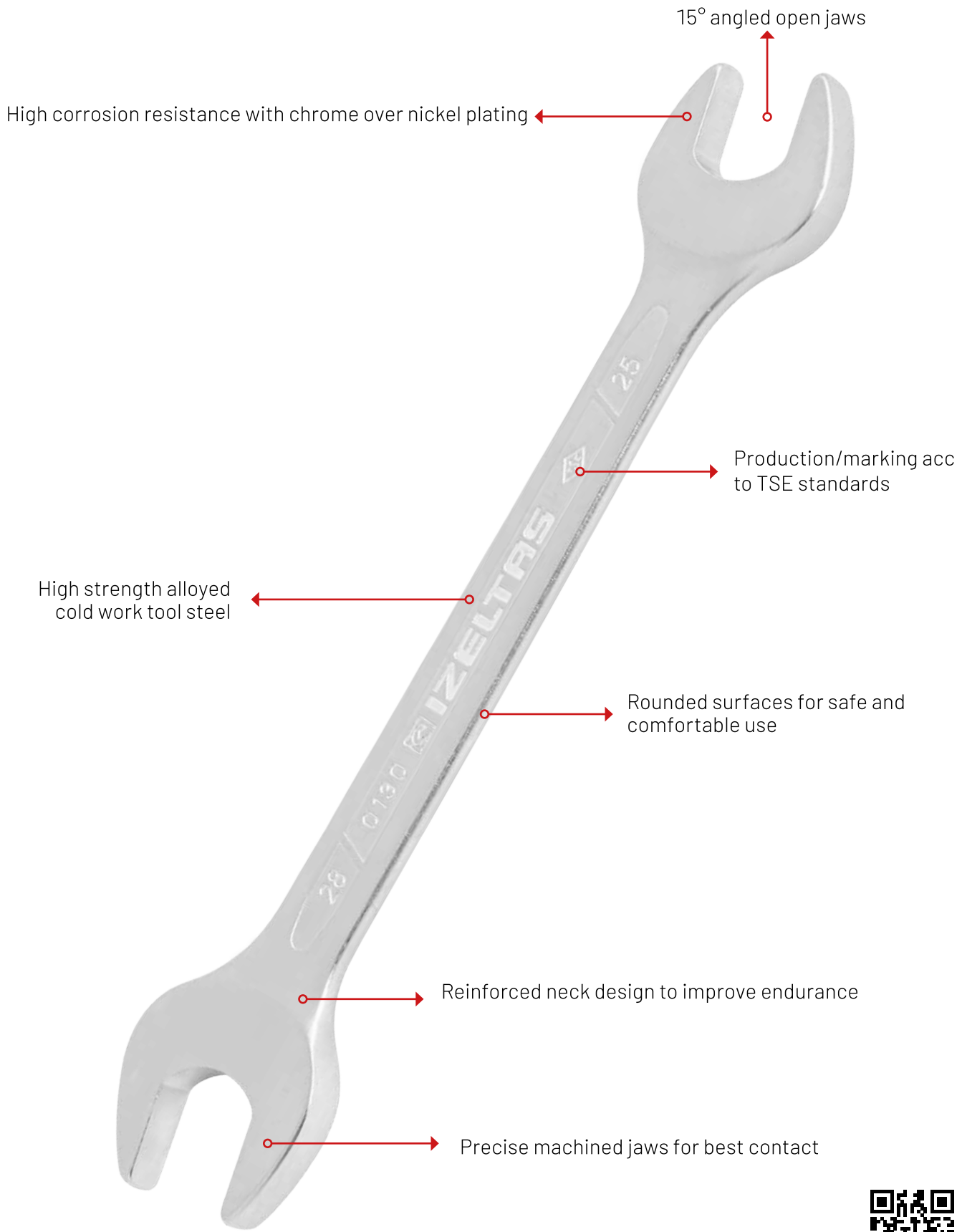

Double Ended Open Jaw Wrench Short Pattern (mm)

 TS 81
 DIN 895

IZELTAS YOUTUBE

Chrom vanadium, Chrom plated

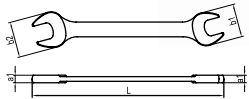

| CODE | mm | L mm | a1 mm | b1 mm | b2 mm | g | |
|--------------|-------|------|-------|-------|-------|-----|----|
| 0100 01 0405 | 4x5 | 97 | 3.5 | 11 | 12.5 | 15 | 10 |
| 0100 01 0607 | 6x7 | 97 | 3.5 | 14 | 16 | 18 | 10 |
| 0100 01 0809 | 8x9 | 108 | 4 | 18 | 20 | 30 | 10 |
| 0100 01 0810 | 8x10 | 117 | 4.5 | 18 | 22 | 33 | 10 |
| 0100 01 1011 | 10x11 | 120 | 4.6 | 22 | 24 | 41 | 10 |
| 0100 01 1012 | 10x12 | 120 | 4.6 | 22 | 26 | 35 | 10 |
| 0100 01 1013 | 10x13 | 120 | 4.6 | 22 | 28 | 38 | 10 |
| 0100 01 1213 | 12x13 | 133 | 5.2 | 26 | 28 | 57 | 10 |
| 0100 01 1214 | 12x14 | 147 | 5.2 | 26 | 30 | 59 | 10 |
| 0100 01 1314 | 13x14 | 147 | 5.2 | 28 | 30 | 66 | 10 |
| 0100 01 1415 | 14x15 | 147 | 5.8 | 30 | 32 | 78 | 10 |
| 0100 01 1317 | 13x17 | 162 | 6.2 | 28 | 36 | 80 | 10 |
| 0100 01 1417 | 14x17 | 162 | 6.2 | 30 | 36 | 90 | 10 |
| 0100 01 1617 | 16x17 | 162 | 6.2 | 34 | 36 | 109 | 10 |
| 0100 01 1719 | 17x19 | 178 | 7 | 36 | 40 | 143 | 10 |
| 0100 01 1819 | 18x19 | 178 | 7 | 38 | 40 | 144 | 10 |
| 0100 01 1922 | 19x22 | 195 | 7.4 | 40 | 46 | 175 | 10 |
| 0100 01 2022 | 20x22 | 195 | 7.4 | 42 | 46 | 196 | 10 |
| 0100 01 2123 | 21x23 | 213 | 7.7 | 44 | 48 | 230 | 10 |
| 0100 01 2224 | 22x24 | 213 | 8 | 46 | 50 | 239 | 10 |
| 0100 01 2426 | 24x26 | 232 | 8.2 | 50 | 54 | 297 | 10 |
| 0100 01 2427 | 24x27 | 232 | 8.2 | 50 | 56 | 296 | 10 |
| 0100 01 2528 | 25x28 | 248 | 8.6 | 52 | 57.5 | 366 | 10 |
| 0100 01 2732 | 27x32 | 265 | 9 | 56 | 66 | 415 | 10 |
| 0100 01 3032 | 30x32 | 265 | 9 | 62 | 66 | 465 | 10 |

SPECIAL SERIES (ask for quantity and delivery terms)

| | | | | | | | |
|--------------|-------|-----|-----|----|----|-----|----|
| 0100 01 0608 | 6x8 | 97 | 3.5 | 14 | 18 | 20 | 10 |
| 0100 01 0708 | 7x8 | 108 | 3.5 | 16 | 18 | 20 | 10 |
| 0100 01 0709 | 7x9 | 108 | 4 | 16 | 20 | 25 | 10 |
| 0100 01 0910 | 9x10 | 117 | 4.6 | 20 | 22 | 30 | 10 |
| 0100 01 0911 | 9x11 | 120 | 4.6 | 20 | 24 | 30 | 10 |
| 0100 01 1014 | 10x14 | 120 | 5.2 | 22 | 30 | 50 | 10 |
| 0100 01 1113 | 11x13 | 133 | 5.2 | 26 | 28 | 50 | 10 |
| 0100 01 1114 | 11x14 | 133 | 5.2 | 26 | 28 | 50 | 10 |
| 0100 01 1315 | 13x15 | 147 | 5.2 | 28 | 30 | 65 | 10 |
| 0100 01 1722 | 17x22 | 195 | 7.4 | 36 | 46 | 160 | 10 |
| 0100 01 1820 | 18x20 | 178 | 7 | 38 | 40 | 125 | 10 |
| 0100 01 1822 | 18x22 | 195 | 7.4 | 40 | 46 | 160 | 10 |
| 0100 01 1924 | 19x24 | 213 | 7.7 | 40 | 50 | 200 | 10 |
| 0100 01 2226 | 22x26 | 232 | 8 | 46 | 54 | 250 | 10 |
| 0100 01 2227 | 22x27 | 232 | 8.2 | 46 | 56 | 260 | 10 |
| 0100 01 2430 | 24x30 | 265 | 9 | 50 | 62 | 370 | 10 |
| 0100 01 2730 | 27x30 | 265 | 9 | 56 | 62 | 380 | 10 |

0100
Double Ended Open Jaw Wrench Short Pattern Set (mm)

| CODE | CONTENTS | g | |
|--------------|--|------|----|
| 0100 00 2108 | 6x7 - 8x9 - 10x11 12x13 - 14x15 - 16x17 18x19 - 20x22 | 736 | 8 |
| 0100 00 2112 | 6x7 - 8x9 - 10x11 12x13 - 14x15 - 16x17 18x19 - 20x22 - 21x23 24x26 - 25x28 - 30x32 | 2110 | 12 |

Double Ended Open Jaw Wrench Long Pattern (mm)

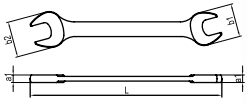
 TS ISO 10102
 DIN 3110

Chrom vanadium, Chrom plated

| CODE | mm | L mm | a1 mm | b1 mm | b2 mm | g | |
|--------------|-------|------|-------|-------|-------|------|----|
| 0130 01 0607 | 6x7 | 125 | 3.5 | 14 | 16 | 24 | 10 |
| 0130 01 0608 | 6x8 | 125 | 3.5 | 14 | 18 | 20 | 10 |
| 0130 01 0809 | 8x9 | 140 | 4 | 18 | 20 | 35 | 10 |
| 0130 01 0810 | 8x10 | 140 | 4 | 18 | 22 | 36 | 10 |
| 0130 01 1011 | 10x11 | 155 | 4.5 | 22 | 24 | 47 | 10 |
| 0130 01 1012 | 10x12 | 162 | 4.7 | 22 | 26 | 57 | 10 |
| 0130 01 1013 | 10x13 | 162 | 4.7 | 22 | 28 | 61 | 10 |
| 0130 01 1014 | 10x14 | 162 | 4.7 | 22 | 28 | 65 | 10 |
| 0130 01 1113 | 11x13 | 172 | 5 | 26 | 28 | 70 | 10 |
| 0130 01 1114 | 11x14 | 172 | 5 | 26 | 30 | 65 | 10 |
| 0130 01 1213 | 12x13 | 172 | 5 | 26 | 28 | 67 | 10 |
| 0130 01 1214 | 12x14 | 172 | 5 | 26 | 30 | 65 | 10 |
| 0130 01 1314 | 13x14 | 188 | 5.5 | 28 | 30 | 85 | 10 |
| 0130 01 1315 | 13x15 | 188 | 5.5 | 30 | 32 | 93 | 10 |
| 0130 01 1415 | 14x15 | 188 | 5.5 | 30 | 32 | 91 | 10 |
| 0130 01 1317 | 13x17 | 205 | 6.2 | 28 | 36 | 111 | 10 |
| 0130 01 1417 | 14x17 | 205 | 6.2 | 30 | 36 | 106 | 10 |
| 0130 01 1617 | 16x17 | 205 | 6.2 | 34 | 36 | 120 | 10 |
| 0130 01 1618 | 16x18 | 220 | 7 | 36 | 40 | 165 | 10 |
| 0130 01 1719 | 17x19 | 220 | 7 | 36 | 40 | 160 | 10 |
| 0130 01 1819 | 18x19 | 220 | 7 | 38 | 40 | 161 | 10 |
| 0130 01 1921 | 19x21 | 235 | 7.5 | 40 | 46 | 195 | 5 |
| 0130 01 1922 | 19x22 | 235 | 7.5 | 40 | 46 | 195 | 5 |
| 0130 01 2022 | 20x22 | 235 | 7.5 | 42 | 46 | 195 | 5 |
| 0130 01 1924 | 19x24 | 248 | 8.3 | 40 | 50 | 235 | 5 |
| 0130 01 2123 | 21x23 | 248 | 8.3 | 44 | 48 | 235 | 5 |
| 0130 01 2224 | 22x24 | 248 | 8.3 | 46 | 50 | 235 | 5 |
| 0130 01 2426 | 24x26 | 265 | 8.8 | 50 | 54 | 300 | 5 |
| 0130 01 2427 | 24x27 | 265 | 8.8 | 50 | 56 | 300 | 5 |
| 0130 01 2430 | 24x30 | 282 | 9.3 | 50 | 61.5 | 380 | 5 |
| 0130 01 2528 | 25x28 | 282 | 9.3 | 52 | 57.5 | 390 | 5 |
| 0130 01 2729 | 27x29 | 300 | 9.8 | 56 | 59 | 400 | 5 |
| 0130 01 2730 | 27x30 | 300 | 9.8 | 56 | 59 | 440 | 5 |
| 0130 01 2732 | 27x32 | 300 | 9.8 | 56 | 65.5 | 460 | 5 |
| 0130 01 3032 | 30x32 | 300 | 9.8 | 61.5 | 65.5 | 480 | 5 |
| 0130 01 3036 | 30x36 | 325 | 10.4 | 61.5 | 76 | 645 | 5 |
| 0130 01 3236 | 32x36 | 325 | 10.4 | 65.5 | 76 | 680 | 5 |
| 0130 01 3436 | 34x36 | 330 | 10.4 | 71 | 76 | 690 | 5 |
| 0130 01 3641 | 36x41 | 360 | 12 | 76 | 87 | 955 | 5 |
| 0130 01 4146 | 41x46 | 400 | 12.5 | 87 | 98 | 1300 | 5 |
| 0130 01 4650 | 46x50 | 450 | 13 | 98 | 107 | 1635 | 5 |

0130

 Double Ended Open Jaw Wrench
 Long Pattern Set (mm)

| CODE | CONTENTS | g | |
|--------------|--|------|----|
| 0130 00 2108 | 6x7 - 8x9 - 10x11 - 12x13 14x15 - 16x17 - 18x19 20x22 | 815 | 8 |
| 0130 00 2112 | 6x7 - 8x9 - 10x11 12x13 - 14x15 - 16x17 18x19 20x22 - 21x23 24x26 - 25x28 - 27x32 | 2315 | 12 |

SPECIAL SERIES (ask for quantity and delivery terms)

| | | | | | | | |
|--------------|-------|-----|-----|----|----|-----|----|
| 0130 01 0555 | 5x5.5 | 125 | 3.5 | 14 | 16 | 15 | 10 |
| 0130 01 0708 | 7x8 | 135 | 3.5 | 16 | 18 | 20 | 10 |
| 0130 01 0709 | 7x9 | 140 | 4 | 16 | 20 | 30 | 10 |
| 0130 01 0910 | 9x10 | 140 | 4 | 18 | 22 | 45 | 10 |
| 0130 01 0911 | 9x11 | 155 | 4.5 | 22 | 24 | 45 | 10 |
| 0130 01 1722 | 17x22 | 235 | 7.5 | 36 | 46 | 190 | 5 |
| 0130 01 1724 | 17x24 | 248 | 8.3 | 36 | 50 | 240 | 5 |
| 0130 01 2227 | 22x27 | 265 | 8.8 | 46 | 56 | 300 | 5 |

0161

Double Ended Open Jaw Wrench Long Pattern (SAE)

TSEK

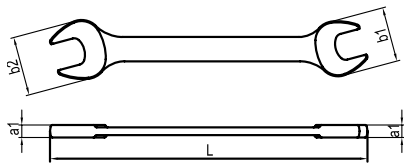

Chrom vanadium, Chrom plated

0161

Double Ended Open Jaw Wrench
Long Pattern Set (SAE)

TSEK

| CODE | inch | L mm | a1 mm | b1 mm | b2 mm | g | |
|--------------|----------------|------|-------|-------|-------|-----|----|
| 0161 01 0608 | 1/4"x5/16" | 125 | 3.5 | 14 | 18 | 18 | 10 |
| 0161 01 0809 | 5/16"x3/8" | 140 | 4 | 18 | 20 | 30 | 10 |
| 0161 01 0810 | 5/16"x11/32" | 140 | 4 | 18 | 20 | 30 | 10 |
| 0161 01 0811 | 5/16"x7/16" | 140 | 4 | 18 | 22 | 30 | 10 |
| 0161 01 0911 | 3/8"x7/16" | 155 | 4.5 | 22 | 24 | 35 | 10 |
| 0161 01 1112 | 7/16"x1/2" | 172 | 5 | 26 | 28 | 40 | 10 |
| 0161 01 1214 | 1/2"x9/16" | 172 | 5 | 26 | 30 | 65 | 10 |
| 0161 01 1416 | 9/16"x5/8" | 188 | 5.5 | 30 | 32 | 85 | 10 |
| 0161 01 1417 | 9/16"x11/16" | 205 | 6.2 | 30 | 36 | 110 | 10 |
| 0161 01 1517 | 19/32"x11/16" | 205 | 6.2 | 34 | 36 | 115 | 10 |
| 0161 01 1619 | 5/8"x3/4" | 220 | 7 | 36 | 40 | 150 | 10 |
| 0161 01 1920 | 3/4"x25/32" | 220 | 7 | 38 | 40 | 160 | 10 |
| 0161 01 2021 | 25/32"x13/16" | 235 | 7.5 | 40 | 46 | 195 | 10 |
| 0161 01 1922 | 3/4"x7/8" | 235 | 7.5 | 40 | 46 | 195 | 10 |
| 0161 01 2122 | 13/16"x7/8" | 248 | 8.3 | 44 | 48 | 235 | 10 |
| 0161 01 2325 | 15/16"x1" | 265 | 8.8 | 50 | 54 | 300 | 10 |
| 0161 01 2328 | 15/16"x1 1/8" | 265 | 8.8 | 50 | 56 | 300 | 10 |
| 0161 01 2628 | 1 1/16"x1 1/8" | 300 | 9.8 | 56 | 59.5 | 460 | 10 |
| 0161 01 2631 | 1 1/16"x1 1/4" | 300 | 9.8 | 56 | 65.5 | 460 | 10 |
| 0161 01 2833 | 1 1/8"x1 5/16" | 300 | 9.8 | 56 | 65.5 | 460 | 10 |



| CODE | CONTENTS | g | |
|--------------|---|------|----|
| 0161 00 2108 | 1/4"x5/16" - 5/16"x3/8" 7/16"x1/2" - 9/16"x5/8"-19/32"x11/16" 3/4"x25/32" - 13/16"x7/8"-15/16"x1" | 1090 | 8 |
| 0161 00 2112 | 1/4"x5/16" - 5/16"x3/8" - 3/8"x7/16" 7/16"x1/2" - 1/2"x9/16" - 9/16"x5/8" 19/32"x11/16" - 3/4"x25/32" - 13/16"x7/8" 15/16"x1" - 1 1/16"x1 1/4" 1 1/8"x1 5/16" | 2165 | 12 |

Single Ended Open Jaw Wrench (mm)



Chrom vanadium

| CODE | mm | L mm | a1 mm | b1 mm | g | |
|--------------|----|------|-------|-------|------|---|
| 0250 01 0030 | 30 | 260 | 10.5 | 60 | 250 | 1 |
| 0250 01 0036 | 36 | 300 | 10.5 | 74.5 | 370 | 1 |
| 0250 01 0041 | 41 | 345 | 12.2 | 85.5 | 550 | 1 |
| 0250 01 0046 | 46 | 390 | 14 | 96.5 | 750 | 1 |
| 0250 01 0050 | 50 | 423 | 15.2 | 105 | 1000 | 1 |
| 0250 01 0055 | 55 | 455 | 16.5 | 113.5 | 1300 | 1 |
| 0250 01 0060 | 60 | 490 | 17.6 | 121 | 1600 | 1 |
| 0250 01 0065 | 65 | 524 | 19 | 130 | 1980 | 1 |

SPECIAL SERIES (ask for quantity and delivery terms)

| | | | | | | |
|--------------|----|-----|------|------|------|---|
| 0250 01 0021 | 21 | 185 | 8 | 42.4 | 95 | 1 |
| 0250 01 0022 | 22 | 195 | 8 | 44.4 | 110 | 1 |
| 0250 01 0023 | 23 | 195 | 8 | 46.3 | 115 | 1 |
| 0250 01 0024 | 24 | 215 | 9 | 48.3 | 150 | 1 |
| 0250 01 0025 | 25 | 215 | 9 | 50.3 | 155 | 1 |
| 0250 01 0027 | 27 | 240 | 9.5 | 54.3 | 200 | 1 |
| 0250 01 0032 | 32 | 274 | 11 | 63 | 300 | 1 |
| 0250 01 0034 | 34 | 274 | 11 | 68 | 320 | 1 |
| 0250 01 0038 | 38 | 300 | 10.5 | 76.8 | 400 | 1 |
| 0250 01 0070 | 70 | 564 | 20.8 | 140 | 2480 | 1 |
| 0250 01 0075 | 75 | 608 | 21.8 | 151 | 3100 | 1 |

Single Ended Open Jaw Wrench Super Insulated (mm)



Chrom vanadium, Chrom plated, Triple PVC insulated

| KOD CODE | mm | L mm | g | |
|--------------|----|------|-----|----|
| 0255 01 0010 | 10 | 110 | 40 | 10 |
| 0255 01 0011 | 11 | 120 | 45 | 10 |
| 0255 01 0012 | 12 | 130 | 50 | 10 |
| 0255 01 0013 | 13 | 140 | 60 | 10 |
| 0255 01 0014 | 14 | 155 | 75 | 10 |
| 0255 01 0017 | 17 | 170 | 100 | 10 |
| 0255 01 0019 | 19 | 185 | 150 | 10 |
| 0255 01 0022 | 22 | 200 | 200 | 10 |
| 0255 01 0024 | 24 | 220 | 280 | 10 |

Speed Wrench (mm)

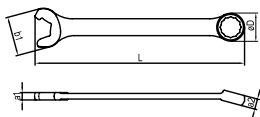

Chrom vanadium, Chrom plated

| CODE | mm | L mm | a1 mm | a2 mm | b1 mm | øD mm | g | |
|--------------|----|------|-------|-------|-------|-------|-----|----|
| 0325 02 0010 | 10 | 135 | 4.3 | 6.9 | 22 | 15.5 | 35 | 10 |
| 0325 02 0013 | 13 | 165 | 5.2 | 7.9 | 28 | 19.5 | 45 | 10 |
| 0325 02 0017 | 17 | 205 | 6.4 | 9.8 | 36 | 25.5 | 110 | 10 |
| 0325 02 0019 | 19 | 225 | 7 | 11 | 40 | 28.5 | 155 | 10 |
| 0325 02 0020 | 20 | 230 | 7.2 | 11.4 | 42 | 30 | 180 | 10 |
| 0325 02 0021 | 21 | 242 | 7.4 | 12 | 44 | 31.5 | 180 | 10 |
| 0325 02 0022 | 22 | 250 | 8.2 | 12.6 | 46 | 33 | 245 | 10 |



IZELTAS YOUTUBE

100% Faster

The 100% new design speed wrench takes the 2-fold speed from the operating principle based on the ratchet mechanism logic. While in use, the ease of rotation without detaching the mounting wrench from the bolt increases the speed of use and the profile that firmly secured to the corners ensures safe and non-slip use

Long Life

This new mounting wrench profile by contacting bolts and nuts, not on corners, but on their flat surfaces, allows regular torx transmission, prevents the increase in surface tension and provides longer life.

- Quick use without detaching the wrench from the bolt.
- Safe torx transmission and long



TS 3794
TS ISO 7738 Form A
DIN 3113



Combination Wrench Short Pattern (mm)

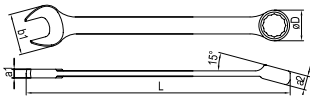

Chrom vanadium, Chrom plated

0320

| CODE | mm | L mm | a1 mm | a2 mm | b1 mm | øD mm | g | |
|--------------|-----|------|-------|-------|-------|-------|-----|----|
| 0320 02 0005 | 5 | 90 | 3.4 | 5.1 | 14 | 10 | 15 | 10 |
| 0320 02 0055 | 5.5 | 90 | 3.4 | 5.1 | 14 | 10 | 15 | 10 |
| 0320 02 0006 | 6 | 100 | 3.4 | 5.1 | 14 | 10 | 15 | 10 |
| 0320 02 0007 | 7 | 110 | 3.6 | 5.5 | 16 | 11 | 20 | 10 |
| 0320 02 0008 | 8 | 120 | 3.8 | 5.9 | 18 | 13 | 25 | 10 |
| 0320 02 0009 | 9 | 130 | 4 | 6.3 | 20 | 14 | 30 | 10 |
| 0320 02 0010 | 10 | 140 | 4.3 | 6.9 | 22 | 15.5 | 40 | 10 |
| 0320 02 0011 | 11 | 150 | 4.5 | 7.3 | 24 | 17 | 45 | 10 |
| 0320 02 0012 | 12 | 160 | 4.9 | 7.7 | 26 | 18.5 | 55 | 10 |
| 0320 02 0013 | 13 | 170 | 5.2 | 7.9 | 28 | 19.5 | 60 | 10 |
| 0320 02 0014 | 14 | 180 | 5.5 | 8.7 | 30 | 21.5 | 75 | 10 |
| 0320 02 0015 | 15 | 190 | 5.8 | 9.1 | 32 | 22.5 | 90 | 10 |
| 0320 02 0016 | 16 | 200 | 6.1 | 9.6 | 34 | 24 | 105 | 10 |
| 0320 02 0017 | 17 | 210 | 6.4 | 9.8 | 36 | 25.5 | 120 | 10 |
| 0320 02 0018 | 18 | 220 | 6.8 | 10.4 | 38 | 27 | 145 | 10 |
| 0320 02 0019 | 19 | 232 | 7 | 11 | 40 | 28.5 | 170 | 10 |
| 0320 02 0020 | 20 | 240 | 7.2 | 11.4 | 42 | 30 | 195 | 10 |
| 0320 02 0021 | 21 | 250 | 7.4 | 12 | 44 | 31.5 | 190 | 10 |
| 0320 02 0022 | 22 | 260 | 8.2 | 12.6 | 46 | 33 | 275 | 10 |
| 0320 02 0023 | 23 | 270 | 8.3 | 13 | 48 | 35 | 255 | 5 |
| 0320 02 0024 | 24 | 280 | 8.5 | 13.6 | 50 | 36.5 | 320 | 5 |
| 0320 02 0025 | 25 | 290 | 8.8 | 14 | 52 | 39 | 320 | 5 |
| 0320 02 0026 | 26 | 300 | 9 | 14.8 | 54 | 41 | 400 | 5 |
| 0320 02 0027 | 27 | 310 | 9.3 | 15 | 56 | 41.5 | 400 | 5 |
| 0320 02 0028 | 28 | 320 | 9.4 | 15.4 | 57.5 | 42.5 | 380 | 5 |
| 0320 02 0029 | 29 | 330 | 10 | 15.6 | 59 | 43.5 | 510 | 5 |
| 0320 02 0030 | 30 | 340 | 10.3 | 16 | 61.5 | 44 | 505 | 5 |
| 0320 02 0032 | 32 | 370 | 10.5 | 16.2 | 65.5 | 47 | 560 | 5 |
| 0320 02 0034 | 34 | 400 | 10.7 | 16.8 | 71 | 50 | 675 | 5 |

Combination Wrench Short Pattern Set (mm)



| CODE | CONTENTS | g | |
|--------------|--|------|----|
| 0320 00 2108 | 6 - 7 - 8 - 9 - 10 - 13 - 17 - 19 | 475 | 8 |
| 0320 00 2112 | 8 - 9 - 10 - 11 - 12 - 13 - 14 15 - 16 - 17 - 19 - 22 | 1190 | 12 |
| 0320 00 2117 | 6 - 7 - 8 - 9 - 10 - 11 - 12 - 13 - 14 15 - 16 - 17 - 18 - 19 - 20 - 21 - 22 | 1760 | 17 |
| 0320 00 2121 | 6 - 7 - 8 - 9 - 10 - 11 - 12 - 13 - 14 15 - 16 - 17 - 18 - 19 - 20 - 21 - 22 24 - 27 - 30 - 32 | 3650 | 21 |

Combination Wrench, Long Pattern (mm)

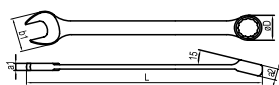

Chrom vanadium, Chrom plated

| CODE | mm | L mm | a1 mm | a2 mm | b1 mm | σD mm | g | |
|--------------|-----|------|-------|-------|-------|-------|------|----|
| 0330 02 0005 | 5 | 95 | 3.2 | 5.2 | 12.5 | 9 | 20 | 10 |
| 0330 02 0055 | 5.5 | 95 | 3.2 | 5.2 | 12.5 | 9 | 20 | 10 |
| 0330 02 0006 | 6 | 105 | 3.8 | 5.6 | 14 | 10.5 | 20 | 10 |
| 0330 02 0007 | 7 | 117 | 4 | 6.1 | 16 | 12 | 20 | 10 |
| 0330 02 0008 | 8 | 130 | 4.2 | 6.6 | 18 | 13.5 | 30 | 10 |
| 0330 02 0009 | 9 | 141 | 4.5 | 7 | 20 | 15 | 40 | 10 |
| 0330 02 0010 | 10 | 154 | 4.7 | 7.6 | 22 | 16 | 50 | 10 |
| 0330 02 0011 | 11 | 166 | 5 | 8.2 | 24 | 17.5 | 60 | 10 |
| 0330 02 0012 | 12 | 178 | 5.2 | 8.7 | 26 | 19 | 70 | 10 |
| 0330 02 0013 | 13 | 190 | 5.6 | 9.2 | 28 | 20.5 | 80 | 10 |
| 0330 02 0014 | 14 | 203 | 5.8 | 9.7 | 30 | 22 | 100 | 10 |
| 0330 02 0015 | 15 | 215 | 6.4 | 10.1 | 32 | 23.5 | 115 | 10 |
| 0330 02 0016 | 16 | 227 | 6.4 | 10.8 | 34 | 25 | 135 | 10 |
| 0330 02 0017 | 17 | 239 | 6.6 | 11.4 | 36 | 26.5 | 160 | 10 |
| 0330 02 0018 | 18 | 250 | 7 | 12 | 38 | 28 | 186 | 10 |
| 0330 02 0019 | 19 | 263 | 7.3 | 12.7 | 40 | 29.5 | 205 | 10 |
| 0330 02 0020 | 20 | 275 | 7.7 | 13.2 | 42 | 31 | 235 | 10 |
| 0330 02 0021 | 21 | 288 | 8.1 | 13.3 | 44 | 31.5 | 260 | 10 |
| 0330 02 0022 | 22 | 300 | 8.5 | 13.7 | 46 | 34 | 300 | 10 |
| 0330 02 0023 | 23 | 315 | 8.8 | 14.2 | 48 | 35.5 | 300 | 5 |
| 0330 02 0024 | 24 | 330 | 9 | 14.2 | 50 | 37 | 390 | 5 |
| 0330 02 0025 | 25 | 340 | 9.3 | 14.7 | 52 | 38.5 | 380 | 5 |
| 0330 02 0026 | 26 | 350 | 9.7 | 14.7 | 54 | 40 | 475 | 5 |
| 0330 02 0027 | 27 | 360 | 10 | 15.2 | 56 | 41 | 475 | 5 |
| 0330 02 0028 | 28 | 370 | 10.4 | 15.7 | 57.5 | 43 | 475 | 5 |
| 0330 02 0029 | 29 | 390 | 10.8 | 16.2 | 59 | 44 | 610 | 5 |
| 0330 02 0030 | 30 | 410 | 11.2 | 16.6 | 61.5 | 45 | 610 | 5 |
| 0330 02 0032 | 32 | 420 | 11.5 | 17.1 | 65.5 | 48 | 755 | 5 |
| 0330 02 0034 | 34 | 430 | 11.8 | 17.4 | 71 | 50.5 | 735 | 5 |
| 0330 02 0036 | 36 | 440 | 12.2 | 17.7 | 76 | 53 | 1000 | 5 |
| 0330 02 0038 | 38 | 450 | 12.5 | 18.7 | 80 | 56 | 1000 | 5 |
| 0330 02 0041 | 41 | 480 | 13.5 | 19.7 | 87 | 61 | 1240 | 5 |
| 0330 02 0046 | 46 | 505 | 14.7 | 20.7 | 95 | 67.5 | 1635 | 1 |
| 0330 02 0050 | 50 | 540 | 15.9 | 22.7 | 104 | 73.5 | 2100 | 1 |

0330

Combination Wrench Long Pattern Set (mm)



| CODE | CONTENTS | g | |
|--------------|---|------|----|
| 0330 00 2108 | 6 - 7 - 8 - 9 - 10 - 13 17 - 19 | 665 | 8 |
| 0330 00 2112 | 8 - 9 - 10 - 11 - 12 13 - 14 - 15 - 16 17 - 19 - 22 | 1780 | 12 |
| 0330 00 2117 | 6 - 7 - 8 - 9 - 10 11 - 12 - 13 - 14 - 15 16 - 17 - 18 - 19 20 - 21 - 22 | 2170 | 17 |
| 0330 00 2121 | 6 - 7 - 8 - 9 - 10 - 11 12 - 13 - 14 - 15 - 16 17 - 18 - 19 - 20 - 21 22 - 24 - 27 - 30 - 32 | 4465 | 21 |



Combination Wrench Long Pattern (SAE)



Chrom vanadium, Chrom plated

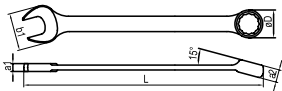

| CODE | inch | L mm | a1 mm | a2 mm | b1 mm | ϕD mm | g | |
|--------------|---------|------|-------|-------|-------|-------|------|----|
| 0331 02 0005 | 3/16" | 95 | 3.2 | 5.2 | 12.5 | 9 | 15 | 10 |
| 0331 02 0006 | 1/4" | 105 | 3.8 | 5.6 | 14 | 10.5 | 20 | 10 |
| 0331 02 0008 | 5/16" | 130 | 4.2 | 6.6 | 18 | 13.5 | 30 | 10 |
| 0331 02 0010 | 3/8" | 154 | 4.7 | 7.6 | 22 | 16 | 50 | 10 |
| 0331 02 0011 | 7/16" | 166 | 5 | 8.2 | 24 | 17.5 | 60 | 10 |
| 0331 02 0013 | 1/2" | 190 | 5.6 | 9.2 | 28 | 20.5 | 80 | 10 |
| 0331 02 0014 | 9/16" | 203 | 5.8 | 9.7 | 30 | 22 | 100 | 10 |
| 0331 02 0015 | 19/32" | 215 | 6.4 | 10.1 | 32 | 23.5 | 115 | 10 |
| 0331 02 0016 | 5/8" | 227 | 6.4 | 10.8 | 34 | 25 | 135 | 10 |
| 0331 02 0017 | 11/16" | 239 | 6.6 | 11.4 | 36 | 26.5 | 155 | 10 |
| 0331 02 0019 | 3/4" | 263 | 7.3 | 12.7 | 40 | 29.5 | 205 | 10 |
| 0331 02 0020 | 25/32" | 275 | 7.7 | 13.2 | 42 | 31 | 230 | 10 |
| 0331 02 0021 | 13/16" | 288 | 8.1 | 13.3 | 44 | 31.5 | 260 | 5 |
| 0331 02 0022 | 7/8" | 300 | 8.5 | 13.7 | 46 | 34 | 310 | 5 |
| 0331 02 0024 | 15/16" | 330 | 9 | 14.2 | 50 | 37 | 380 | 5 |
| 0331 02 0025 | 1" | 340 | 9.3 | 14.7 | 52 | 38.5 | 380 | 5 |
| 0331 02 0027 | 1 1/16" | 360 | 10 | 15.2 | 56 | 41 | 470 | 5 |
| 0331 02 0028 | 1 1/8" | 370 | 10.4 | 15.7 | 57.5 | 43 | 470 | 5 |
| 0331 02 0030 | 1 3/16" | 410 | 11.2 | 16.6 | 61.5 | 45 | 635 | 5 |
| 0331 02 0032 | 1 1/4" | 420 | 11.5 | 17.1 | 65.5 | 48 | 775 | 5 |
| 0331 02 0033 | 1 5/16" | 430 | 11.8 | 17.4 | 71 | 50.5 | 775 | 5 |
| 0331 02 0038 | 1 1/2" | 450 | 12.5 | 18.7 | 80 | 56 | 1015 | 5 |

SPECIAL SERIES (ask for quantity and delivery terms)

| | | | | | | | | |
|--------------|----------|-----|------|------|-----|------|------|---|
| 0331 02 0035 | 1 3/8" | 440 | 12.2 | 17.7 | 76 | 53 | 1015 | 5 |
| 0331 02 0036 | 1 7/16" | 440 | 12.2 | 17.7 | 76 | 53 | 1015 | 5 |
| 0331 02 0041 | 1 5/8" | 480 | 13.5 | 19.7 | 87 | 61 | 1325 | 5 |
| 0331 02 0046 | 1 13/16" | 505 | 14.7 | 20.7 | 95 | 67.5 | 1750 | 5 |
| 0331 02 0050 | 2" | 540 | 15.9 | 22.7 | 104 | 73.5 | 2200 | 5 |

0331

Combination Wrench Long Pattern Set (SAE)



| CODE | CONTENTS | g | |
|--------------|---|------|----|
| 0331 00 2108 | 5/16" - 3/8" - 7/16" - 1/2" - 9/16" - 5/8" - 11/16" - 3/4" | 925 | 8 |
| 0331 00 2112 | 5/16" - 3/8" - 7/16" - 1/2" - 9/16" - 5/8" - 11/16" - 3/4" - 13/16" - 7/8" - 15/16" - 1" | 2320 | 12 |
| 0331 00 2117 | 1/4" - 5/16" - 3/8" - 7/16" - 1/2" - 9/16" - 19/32" - 5/8" - 11/16" - 3/4" - 25/32" - 13/16" - 7/8" - 15/16" - 1" - 1 1/16" - 1 3/16" | 3875 | 17 |
| 0331 00 2120 | 1/4" - 5/16" - 3/8" - 7/16" - 1/2" - 9/16" - 19/32" - 5/8" - 11/16" - 3/4" - 25/32" - 13/16" - 7/8" - 15/16" - 1" - 1 1/16" - 1 1/8" - 1 3/16" - 1 1/4" - 1 5/16" | 5880 | 20 |

Combination Wrench With Ratchet (mm)

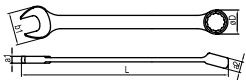

Chrom vanadium, Chrom plated

| CODE | Ø mm | L mm | a1 mm | a2 mm | b1 mm | øD mm | g | □ |
|--------------|------|------|-------|-------|-------|-------|-----|----|
| 0340 02 0008 | 8 | 136 | 4.2 | 7.6 | 18.2 | 19.1 | 35 | 10 |
| 0340 02 0009 | 9 | 143 | 4.5 | 7.6 | 20.2 | 19.1 | 40 | 10 |
| 0340 02 0010 | 10 | 160 | 4.7 | 8 | 22.1 | 22 | 55 | 10 |
| 0340 02 0011 | 11 | 169 | 5 | 8 | 24.1 | 22 | 70 | 10 |
| 0340 02 0012 | 12 | 174 | 5.2 | 9 | 26.1 | 26 | 80 | 10 |
| 0340 02 0013 | 13 | 180 | 5.6 | 9 | 28.1 | 26 | 90 | 10 |
| 0340 02 0014 | 14 | 193 | 6 | 10 | 30.1 | 30 | 120 | 10 |
| 0340 02 0015 | 15 | 200 | 6.4 | 10 | 32.1 | 30 | 135 | 10 |
| 0340 02 0016 | 16 | 216 | 6.4 | 10.6 | 34.1 | 33 | 155 | 10 |
| 0340 02 0017 | 17 | 233 | 6.6 | 10.6 | 36.1 | 33 | 190 | 10 |
| 0340 02 0018 | 18 | 239 | 7 | 11.8 | 38 | 36.1 | 200 | 10 |
| 0340 02 0019 | 19 | 250 | 7.3 | 11.8 | 40 | 36.1 | 240 | 10 |
| 0340 02 0021 | 21 | 285 | 8.1 | 12.6 | 44 | 42.5 | 350 | 10 |
| 0340 02 0022 | 22 | 285 | 8.5 | 12.6 | 46 | 42.5 | 340 | 10 |
| 0340 02 0024 | 24 | 325 | 9 | 13.2 | 50 | 46.5 | 470 | 5 |

0340

Combination Wrench With Ratchet, Set (mm)



| CODE | CONTENTS | g | □ |
|--------------|---|------|----|
| 0340 00 2110 | 8 - 9 - 10 - 11 12 - 13 - 14 - 15 - 17 - 19 | 1315 | 10 |
| 0340 00 2115 | 8 - 9 - 10 - 11 - 12 - 13 14 - 15 - 16 - 17 - 18 - 19 - 21 - 22 - 24 | 2445 | 15 |

13000 005343

Combination Wrench With Ratchet Set (4 pcs, mm)



| CODE | CONTENTS | g | □ |
|--------------|-------------------|-----|---|
| 13000 005343 | 10 - 13 - 17 - 19 | 595 | 4 |



0345

Flexible Head Combination Wrench With Ratchet (mm)

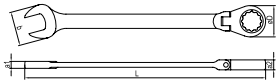

Chrom vanadium, Chrom plated

| CODE | mm | L mm | a1 mm | a2 mm | b mm | σD mm | g | □ |
|--------------|----|------|-------|-------|------|-------|-----|----|
| 0345 02 0008 | 8 | 136 | 5.5 | 7 | 17 | 17.5 | 40 | 10 |
| 0345 02 0009 | 9 | 140 | 6.1 | 7.7 | 21.5 | 21 | 50 | 10 |
| 0345 02 0010 | 10 | 140 | 6.1 | 7.7 | 21.5 | 21 | 60 | 10 |
| 0345 02 0011 | 11 | 142 | 6.4 | 8.3 | 23.5 | 22.5 | 80 | 10 |
| 0345 02 0012 | 12 | 143 | 6.7 | 8.7 | 26 | 24 | 90 | 10 |
| 0345 02 0013 | 13 | 156 | 7 | 9.3 | 27 | 26 | 105 | 10 |
| 0345 02 0014 | 14 | 164 | 7.3 | 9.4 | 30.5 | 27.5 | 125 | 10 |
| 0345 02 0015 | 15 | 174 | 7.7 | 10 | 32 | 29 | 145 | 10 |
| 0345 02 0016 | 16 | 176 | 8 | 10.6 | 34 | 30.5 | 185 | 10 |
| 0345 02 0017 | 17 | 195 | 8.3 | 10.9 | 37 | 32.5 | 210 | 10 |
| 0345 02 0018 | 18 | 213 | 8.6 | 11.2 | 38.5 | 33.5 | 235 | 10 |
| 0345 02 0019 | 19 | 214 | 9 | 11.5 | 40 | 35 | 260 | 10 |

0345 00 2112

Flexible Head Combination Wrench With Ratchet, Set (mm)



| CODE | CONTENTS | g | □ |
|--------------|--|------|----|
| 0345 00 2112 | 8 - 9 - 10 - 11 - 12 - 13 14 - 15 - 16 - 17 - 18 - 19 | 1365 | 12 |

0335 02 0010

Multi-Ring Wrench (mm)



Chrom vanadium, Chrom plated

| CODE | SIZE | L mm | g | □ |
|--------------|-------------|------|-----|---|
| 0335 02 0010 | 10x13x17x19 | 230 | 215 | 5 |

Offset Combination Wrench (mm)

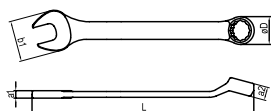
 TS 3794
 TS ISO 7738 Form B
 DIN 3113

Chrom vanadium, Chrom plated

0370
Offset Combination Wrench, Set (mm)

| CODE | mm | L mm | a1 mm | a2 mm | b1 mm | σD mm | g | |
|--------------|----|------|-------|-------|-------|-------|------|----|
| 0370 02 0006 | 6 | 110 | 3.8 | 5.6 | 16 | 10.5 | 20 | 10 |
| 0370 02 0007 | 7 | 120 | 4 | 6.2 | 18 | 12 | 25 | 10 |
| 0370 02 0008 | 8 | 130 | 4.2 | 6.7 | 20 | 13 | 30 | 10 |
| 0370 02 0009 | 9 | 140 | 4.4 | 7.3 | 22 | 14.5 | 35 | 10 |
| 0370 02 0010 | 10 | 150 | 4.6 | 7.8 | 24 | 16 | 40 | 10 |
| 0370 02 0011 | 11 | 160 | 4.8 | 8.4 | 26 | 17 | 50 | 10 |
| 0370 02 0012 | 12 | 167 | 5 | 9 | 28 | 18.5 | 65 | 10 |
| 0370 02 0013 | 13 | 175 | 5.4 | 9.6 | 30 | 20 | 75 | 10 |
| 0370 02 0014 | 14 | 185 | 5.8 | 10.2 | 32 | 21.5 | 90 | 10 |
| 0370 02 0015 | 15 | 195 | 6.2 | 10.8 | 34 | 23 | 105 | 10 |
| 0370 02 0016 | 16 | 210 | 6.6 | 11.4 | 36 | 24.5 | 120 | 10 |
| 0370 02 0017 | 17 | 225 | 7 | 12 | 38 | 26 | 160 | 10 |
| 0370 02 0018 | 18 | 237 | 7.4 | 12.4 | 40 | 27.5 | 170 | 10 |
| 0370 02 0019 | 19 | 250 | 7.8 | 13 | 42 | 29 | 200 | 10 |
| 0370 02 0020 | 20 | 267 | 8.2 | 13.2 | 44 | 30.5 | 230 | 10 |
| 0370 02 0021 | 21 | 283 | 8.6 | 13.8 | 46 | 32 | 265 | 10 |
| 0370 02 0022 | 22 | 295 | 9.1 | 14.6 | 48 | 34.5 | 300 | 10 |
| 0370 02 0023 | 23 | 295 | 9.1 | 14.6 | 48 | 34.5 | 300 | 5 |
| 0370 02 0024 | 24 | 329 | 9.4 | 15.4 | 52 | 37 | 380 | 5 |
| 0370 02 0025 | 25 | 329 | 9.4 | 15.4 | 52 | 37 | 380 | 5 |
| 0370 02 0026 | 26 | 360 | 10.2 | 16.8 | 58 | 41 | 485 | 5 |
| 0370 02 0027 | 27 | 360 | 10.2 | 16.8 | 58 | 41 | 475 | 5 |
| 0370 02 0028 | 28 | 360 | 10.2 | 16.8 | 58 | 41 | 470 | 5 |
| 0370 02 0029 | 29 | 394 | 11 | 18.2 | 64 | 44.5 | 610 | 5 |
| 0370 02 0030 | 30 | 394 | 11 | 18.2 | 64 | 44.5 | 620 | 5 |
| 0370 02 0032 | 32 | 435 | 11.8 | 19.7 | 66 | 47.5 | 765 | 5 |
| 0370 02 0036 | 36 | 468 | 12.6 | 21.2 | 76 | 53 | 1020 | 5 |

| CODE | CONTENTS | g | |
|--------------|--|------|----|
| 0370 00 2108 | 6 - 7 - 8 - 9 - 10 - 13 - 17 - 19 | 665 | 8 |
| 0370 00 2112 | 8 - 9 - 10 - 11 - 12 - 13 - 14 15 - 16 - 17 - 19 - 22 | 1375 | 12 |
| 0370 00 2117 | 6 - 7 - 8 - 9 - 10 - 11 - 12 - 13 - 14 15 - 16 - 17 - 18 - 19 - 20 - 21 - 22 | 2100 | 17 |
| 0370 00 2121 | 6 - 7 - 8 - 9 - 10 - 11 - 12 - 13 - 14 - 15 16 - 17 - 18 - 19 - 20 - 21 - 22 - 24 - 27 30 - 32 | 4425 | 21 |

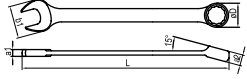
Torx®- mm Combination Wrench

Chrom vanadium, Chrom plated

| CODE | mm | | L mm | a1 mm | a2 mm | b1 mm | øD mm | g | |
|--------------|----|-----|------|-------|-------|-------|-------|-----|----|
| 0380 02 0008 | 8 | E10 | 170 | 4.5 | 7.5 | 20.5 | 13 | 45 | 10 |
| 0380 02 0009 | 9 | E12 | 180 | 4.5 | 8 | 22.5 | 14.5 | 45 | 10 |
| 0380 02 0010 | 10 | E14 | 190 | 5 | 8.5 | 24.5 | 16 | 60 | 10 |
| 0380 02 0011 | 11 | E14 | 200 | 5.5 | 9 | 26.5 | 17 | 75 | 10 |
| 0380 02 0012 | 12 | E16 | 210 | 6 | 9.5 | 28.5 | 19 | 90 | 10 |
| 0380 02 0013 | 13 | E18 | 225 | 6.5 | 10 | 30.5 | 20 | 110 | 10 |
| 0380 02 0014 | 14 | E18 | 235 | 7 | 11 | 32.5 | 22 | 120 | 10 |
| 0380 02 0015 | 15 | E20 | 250 | 7.5 | 12 | 34.5 | 23 | 150 | 10 |
| 0380 02 0017 | 17 | E22 | 280 | 8.5 | 14 | 38.5 | 26.5 | 210 | 10 |
| 0380 02 0018 | 18 | E24 | 295 | 9 | 15 | 40.5 | 28 | 240 | 10 |
| 0380 02 0019 | 19 | E24 | 310 | 9.5 | 16 | 42.5 | 29.5 | 280 | 10 |
| 0380 02 0022 | 22 | E26 | 350 | 11 | 18 | 48.5 | 34.5 | 410 | 10 |

0380
Torx®- mm Combination Wrench Set



TORX-mm combination wrench: Our wrenches consisting of an open end and a ring end are available in sizes from 8 to 22 mm. Unlike the existing open end wrenches, its open end can unbolt and tighten bolts with different geometries as well as the

| CODE | CONTENTS | g | |
|--------------|--|------|----|
| | 8 - 9 - 10 - 11 - 12 - 13 - 17 - 19 | | |
| 0380 00 2108 | E10 - E12 - E14 - E14 E16 - E18 - E22 - E24 | 790 | 8 |
| | 8 - 9 - 10 - 11 - 12 - 13 14 - 15 - 17 - 18 - 19 - 22 | | |
| 0380 00 2112 | E10 - E12 - E14 - E14 - E16 - E18 E18 - E20 - E22 - E24 - E24 - E26 | 1590 | 12 |

Double Ended Ring Wrench (mm)

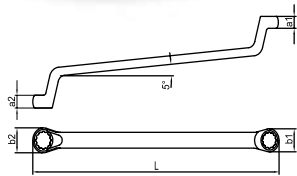

TS 3794
TS ISO 10104 Form B
DIN 838



Chrom vanadium, Chrom plated

| CODE | mm | L mm | a1 mm | a2 mm | b1 mm | b2 mm | g | |
|--------------|-------|------|-------|-------|-------|-------|------|----|
| 0430 03 0607 | 6x7 | 176 | 5.6 | 6 | 10 | 11.5 | 55 | 10 |
| 0430 03 0809 | 8x9 | 190 | 6.4 | 6.8 | 13 | 14.5 | 75 | 10 |
| 0430 03 0810 | 8x10 | 190 | 6.4 | 7.3 | 13 | 15.5 | 70 | 10 |
| 0430 03 1011 | 10x11 | 206 | 7.3 | 7.6 | 15.5 | 17 | 105 | 10 |
| 0430 03 1012 | 10x12 | 206 | 7.3 | 8.5 | 15.5 | 18.5 | 105 | 10 |
| 0430 03 1013 | 10x13 | 220 | 7.3 | 9 | 15.5 | 20 | 120 | 10 |
| 0430 03 1113 | 11x13 | 220 | 8.5 | 9 | 18.5 | 20 | 130 | 10 |
| 0430 03 1213 | 12x13 | 220 | 8.5 | 9 | 18.5 | 20 | 135 | 10 |
| 0430 03 1214 | 12x14 | 220 | 8.5 | 9.5 | 18.5 | 23 | 145 | 10 |
| 0430 03 1415 | 14x15 | 236 | 9.5 | 10 | 21.5 | 23 | 180 | 10 |
| 0430 03 1317 | 13x17 | 250 | 9 | 11.5 | 20 | 26.5 | 215 | 10 |
| 0430 03 1417 | 14x17 | 250 | 9.5 | 11.5 | 21.5 | 26.5 | 210 | 10 |
| 0430 03 1617 | 16x17 | 250 | 10.8 | 11.5 | 25 | 26.5 | 220 | 10 |
| 0430 03 1618 | 16x18 | 260 | 10.8 | 12 | 25 | 27.5 | 210 | 10 |
| 0430 03 1719 | 17x19 | 271 | 11.5 | 12.5 | 26.5 | 29 | 270 | 10 |
| 0430 03 1819 | 18x19 | 271 | 12 | 12.5 | 27.5 | 29 | 270 | 10 |
| 0430 03 1922 | 19x22 | 291 | 12.5 | 13.5 | 29 | 33 | 330 | 5 |
| 0430 03 1924 | 19x24 | 311 | 12.5 | 14.2 | 29 | 36.5 | 345 | 5 |
| 0430 03 2022 | 20x22 | 291 | 12.9 | 13.5 | 30.5 | 33 | 330 | 5 |
| 0430 03 2123 | 21x23 | 311 | 13.1 | 14 | 32 | 35 | 410 | 5 |
| 0430 03 2224 | 22x24 | 321 | 13.5 | 14.2 | 33 | 36.5 | 410 | 5 |
| 0430 03 2426 | 24x26 | 331 | 14.2 | 14.6 | 36.5 | 39.5 | 495 | 5 |
| 0430 03 2427 | 24x27 | 331 | 14.2 | 15 | 36.5 | 40.5 | 495 | 5 |
| 0430 03 2430 | 24x30 | 352 | 14.2 | 16.7 | 36.5 | 45 | 530 | 5 |
| 0430 03 2528 | 25x28 | 352 | 14.5 | 15.5 | 38 | 42.5 | 550 | 5 |
| 0430 03 2729 | 27x29 | 371 | 15 | 16.7 | 40.5 | 45 | 660 | 5 |
| 0430 03 2730 | 27x30 | 371 | 15 | 16.7 | 40.5 | 45 | 660 | 5 |
| 0430 03 2732 | 27x32 | 371 | 15 | 16.7 | 40.5 | 47.5 | 660 | 5 |
| 0430 03 3032 | 30x32 | 371 | 16.4 | 16.7 | 45 | 47.5 | 660 | 5 |
| 0430 03 3036 | 30x36 | 402 | 16.4 | 17.5 | 45 | 53 | 880 | 5 |
| 0430 03 3236 | 32x36 | 402 | 16.7 | 17.5 | 47.5 | 53 | 890 | 5 |
| 0430 03 3436 | 34x36 | 420 | 17.1 | 17.5 | 50 | 53 | 1000 | 5 |
| 0430 03 3641 | 36x41 | 438 | 17.5 | 19.5 | 53 | 61 | 1150 | 5 |
| 0430 03 4146 | 41x46 | 485 | 19.5 | 20.5 | 61 | 67.5 | 1430 | 5 |
| 0430 03 4650 | 46x50 | 535 | 20.5 | 22.4 | 67.5 | 73.5 | 1960 | 5 |

0430

Double Ended Ring Wrench Set (mm)



| CODE | CONTENTS | g | |
|--------------|---|------|----|
| 0430 00 2108 | 6x7 - 8x9 - 10x11 - 12x13 - 14x15 16x17 - 18x19 - 20x22 | 1450 | 8 |
| 0430 00 2112 | 6x7 - 8x9 - 10x11 - 12x13 - 14x15 16x17 - 18x19 - 20x22 - 21x23 24x26 - 25x28 - 27x32 | 3610 | 12 |

SPECIAL SERIES (ask for quantity and delivery terms)

| | | | | | | | | |
|--------------|-------|-----|------|------|------|------|-----|----|
| 0430 03 1014 | 10x14 | 220 | 7.3 | 9 | 15.5 | 21.5 | 120 | 10 |
| 0430 03 1315 | 13x15 | 236 | 9 | 10 | 20 | 23 | 170 | 10 |
| 0430 03 2227 | 22x27 | 331 | 14.2 | 15 | 36.5 | 40.5 | 500 | 5 |
| 0430 03 3034 | 30x34 | 379 | 16.4 | 16.9 | 45 | 50 | 690 | 5 |



TSEK

Double Ended Ring Wrench (SAE)



Chrom vanadium, Chrom plated

0431

TSEK

Double Ended Ring Wrench, Set (SAE)

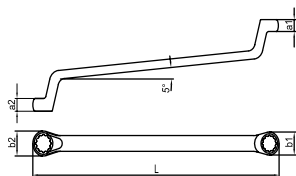

| CODE | inch | L mm | a1 mm | a2 mm | b1 mm | b2 mm | g | |
|--------------|-----------------|------|-------|-------|-------|-------|-----|----|
| 0431 03 0608 | 1/4"x5/16" | 176 | 5.6 | 6 | 10 | 11.5 | 55 | 10 |
| 0431 03 0809 | 5/16"x3/8" | 190 | 6.4 | 6.8 | 13 | 14.5 | 75 | 10 |
| 0431 03 0811 | 5/16"x7/16" | 190 | 6.4 | 7.3 | 13 | 15.5 | 115 | 10 |
| 0431 03 0911 | 3/8"x7/16" | 206 | 7.3 | 7.6 | 15.5 | 17 | 115 | 10 |
| 0431 03 1112 | 7/16"x1/2" | 220 | 8.5 | 9 | 18.5 | 20 | 135 | 10 |
| 0431 03 1214 | 1/2"x9/16" | 236 | 9 | 10 | 20 | 23 | 145 | 10 |
| 0431 03 1415 | 9/16"x19/32" | 236 | 9.5 | 10 | 21.5 | 23 | 165 | 10 |
| 0431 03 1416 | 9/16"x5/8" | 236 | 9.5 | 10 | 21.5 | 24 | 165 | 10 |
| 0431 03 1517 | 19/32"x11/16" | 250 | 10.8 | 11.5 | 25 | 26.5 | 210 | 10 |
| 0431 03 1920 | 3/4"x25/32" | 271 | 12 | 12.5 | 27.5 | 29 | 270 | 10 |
| 0431 03 2122 | 13/16"x7/8" | 311 | 13.1 | 14 | 32 | 35 | 400 | 5 |
| 0431 03 2325 | 15/16"x1" | 331 | 14.2 | 14.6 | 36.5 | 39.5 | 495 | 5 |
| 0431 03 2831 | 1 1/16"x1 1/4" | 371 | 15 | 16.7 | 40.5 | 48 | 640 | 5 |
| 0431 03 2833 | 1 1/8"x1 5/16" | 371 | 15 | 16.7 | 40.5 | 48 | 660 | 5 |
| 0431 03 3033 | 1 3/16"x1 5/16" | 371 | 16.4 | 16.7 | 45 | 48 | 670 | 5 |

SPECIAL SERIES (ask for quantity and delivery terms)

| | | | | | | | | |
|--------------|-----------------|-----|------|------|------|------|------|----|
| 0431 03 1217 | 1/2"x11/16" | 250 | 9 | 10 | 20 | 26.5 | 185 | 10 |
| 0431 03 1417 | 9/16"x11/16" | 250 | 9.5 | 11.5 | 21.5 | 26.5 | 185 | 10 |
| 0431 03 1617 | 5/8"x11/16" | 250 | 10.8 | 11.5 | 25 | 26.5 | 210 | 10 |
| 0431 03 1619 | 5/8"x3/4" | 271 | 11.5 | 12.5 | 26.5 | 29 | 270 | 10 |
| 0431 03 2021 | 25/32"x13/16" | 291 | 12.9 | 13.5 | 30.5 | 33 | 270 | 5 |
| 0431 03 1922 | 3/4"x7/8" | 291 | 12.9 | 13.5 | 30.5 | 33 | 400 | 5 |
| 0431 03 2223 | 7/8"x15/16" | 321 | 13.5 | 14.2 | 33 | 36.5 | 400 | 5 |
| 0431 03 2328 | 15/16"x1 1/8" | 331 | 14.2 | 15 | 36.5 | 40.5 | 500 | 5 |
| 0431 03 2528 | 1"x1 1/8" | 352 | 14.5 | 15.5 | 38 | 42.5 | 570 | 5 |
| 0431 03 3036 | 1 3/16"x1 3/8" | 402 | 16.4 | 17.5 | 45 | 53 | 880 | 5 |
| 0431 03 3236 | 1 1/4"x1 7/16" | 402 | 16.7 | 17.5 | 48 | 53 | 890 | 5 |
| 0431 03 3641 | 1 7/16"x1 5/8" | 438 | 17.5 | 19.5 | 53 | 61 | 1100 | 5 |
| 0431 03 4146 | 1 11/16"x1 7/8" | 485 | 19.5 | 20.5 | 61 | 67.5 | 1390 | 5 |
| 0431 03 4650 | 1 13/16"x2" | 535 | 20.5 | 22.5 | 67.5 | 73.5 | 1955 | 5 |

| CODE | CONTENTS | g | |
|--------------|--|------|----|
| 0431 00 2108 | 1/4"x5/16" - 5/16"x3/8" 7/16"x1/2" - 9/16"x5/8" 19/32"x11/16" 3/4"x25/32" - 13/16"x7/8" 15/16"x1" | 1915 | 8 |
| 0431 00 2112 | 1/4"x5/16" - 5/16"x3/8" 3/8"x7/16" - 7/16"x1/2" 9/16"x5/8" - 19/32"x11/16" 3/4"x25/32" - 13/16"x7/8" 15/16"x1" - 1 1/16"x1 1/4" 1 1/8"x1 5/16" 1 3/16"x1 5/16" | 3985 | 12 |

Flat Ring Wrench (mm)

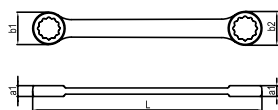

 TS 3794
 TS ISO 10103
 DIN 837 -B

| CODE | mm | L mm | a1 mm | b1 mm | b2 mm | g | |
|--------------|-------|------|-------|-------|-------|-----|----|
| 0440 03 0607 | 6x7 | 99 | 4.4 | 9.5 | 11 | 10 | 10 |
| 0440 03 0809 | 8x9 | 113 | 5.2 | 12.5 | 14 | 25 | 10 |
| 0440 03 1011 | 10x11 | 125 | 6 | 15.5 | 16.5 | 30 | 10 |
| 0440 03 1213 | 12x13 | 140 | 6.8 | 18.5 | 20 | 45 | 10 |
| 0440 03 1415 | 14x15 | 156 | 7.2 | 21 | 22.5 | 60 | 10 |
| 0440 03 1617 | 16x17 | 170 | 8 | 24 | 25 | 80 | 10 |
| 0440 03 1819 | 18x19 | 188 | 8.8 | 26.5 | 27.5 | 105 | 10 |
| 0440 03 2022 | 20x22 | 208 | 9.6 | 29 | 32 | 135 | 10 |
| 0440 03 2123 | 21x23 | 230 | 10.6 | 30 | 33 | 170 | 10 |
| 0440 03 2426 | 24x26 | 256 | 10.8 | 35 | 37.5 | 225 | 10 |
| 0440 03 2528 | 25x28 | 280 | 11.8 | 36 | 40.5 | 270 | 10 |
| 0440 03 2732 | 27x32 | 310 | 12.8 | 38.5 | 45.5 | 355 | 10 |

Chrom vanadium, Chrom plated

0440

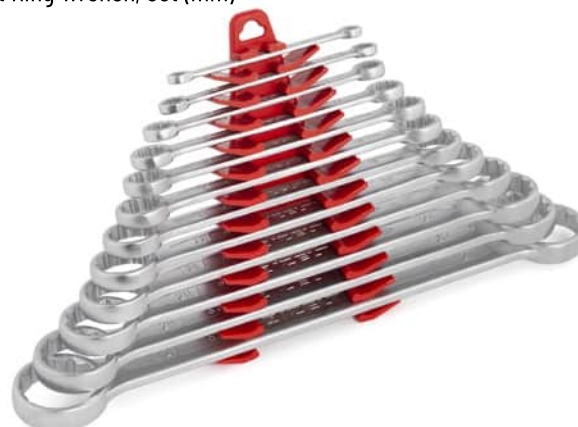
Flat Ring Wrench, Set (mm)

SPECIAL SERIES (ask for quantity and delivery terms)

| | | | | | | | |
|--------------|-------|-----|------|------|------|-----|----|
| 0440 03 0810 | 8x10 | 120 | 5.6 | 12.5 | 15.5 | 30 | 10 |
| 0440 03 1013 | 10x13 | 140 | 6.8 | 18.5 | 20 | 45 | 10 |
| 0440 03 1315 | 13x15 | 156 | 7.2 | 20 | 22.5 | 55 | 10 |
| 0440 03 1317 | 13x17 | 165 | 7.8 | 20.2 | 25.2 | 85 | 10 |
| 0440 03 1618 | 16x18 | 188 | 8.8 | 26.5 | 27.5 | 90 | 10 |
| 0440 03 1719 | 17x19 | 188 | 8.8 | 26.5 | 27.5 | 105 | 10 |
| 0440 03 2224 | 22x24 | 230 | 10.8 | 32 | 35 | 170 | 10 |
| 0440 03 2427 | 24x27 | 256 | 10.8 | 35 | 38.5 | 225 | 10 |
| 0440 03 2729 | 27x29 | 290 | 12.8 | 38.5 | 42.5 | 285 | 10 |
| 0440 03 3032 | 30x32 | 310 | 12.8 | 43 | 45.5 | 360 | 10 |

| CODE | CONTENTS | g | |
|--------------|---|------|----|
| 0440 00 2108 | 6x7 - 8x9 - 10x11 - 12x13 - 14x15 16x17 - 18x19 - 20x22 | 560 | 8 |
| 0440 00 2112 | 6x7 - 8x9 - 10x11 - 12x13 - 14x15 16x17 - 18x19 - 20x22 - 21x23 24x26 - 25x28 - 27x32 | 1540 | 12 |

0435

Single Ended Ring Wrench Super Insulated (mm)

± 1000 V
IEC 60900

TSEK



Chrom vanadium, Chrom plated, Triple PVC insulated

| CODE | mm | L mm | g | |
|--------------|----|------|-----|----|
| 0435 03 0010 | 10 | 170 | 100 | 10 |
| 0435 03 0011 | 11 | 175 | 110 | 10 |
| 0435 03 0012 | 12 | 180 | 130 | 10 |
| 0435 03 0013 | 13 | 185 | 150 | 10 |
| 0435 03 0014 | 14 | 190 | 180 | 10 |
| 0435 03 0017 | 17 | 205 | 220 | 10 |
| 0435 03 0019 | 19 | 220 | 270 | 10 |
| 0435 03 0022 | 22 | 245 | 310 | 10 |
| 0435 03 0024 | 24 | 270 | 420 | 10 |

0530

Double - Hex Starter and Block Wrench (mm)

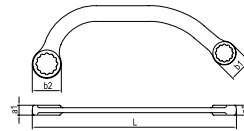

Chrom vanadium, Chrom plated

| CODE | mm | L mm | a1 mm | b1 mm | b2 mm | g | |
|--------------|-------|------|-------|-------|-------|-----|----|
| 0530 04 0810 | 8x10 | 120 | 6 | 12.5 | 15.5 | 30 | 10 |
| 0530 04 1011 | 10x11 | 150 | 7 | 17 | 20 | 55 | 10 |
| 0530 04 1012 | 10x12 | 150 | 7 | 17 | 20 | 55 | 10 |
| 0530 04 1113 | 11x13 | 150 | 7 | 17 | 20 | 55 | 10 |
| 0530 04 1315 | 13x15 | 185 | 9 | 21.5 | 26 | 110 | 10 |
| 0530 04 1317 | 13x17 | 185 | 9 | 21.5 | 26 | 105 | 10 |
| 0530 04 1417 | 14x17 | 185 | 9 | 21.5 | 26 | 110 | 10 |
| 0530 04 1517 | 15x17 | 185 | 9 | 21.5 | 26 | 100 | 10 |
| 0530 04 1922 | 19x22 | 230 | 11 | 29 | 33 | 195 | 10 |

0540

Flare Nut Wrench (mm)

DIN 3118

TSEK

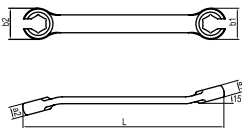

Chrom vanadium, Chrom plated

| CODE | mm | L mm | a1 mm | a2 mm | b1 mm | b2 mm | g | |
|--------------|-------|------|-------|-------|-------|-------|-----|----|
| 0540 01 0810 | 8x10 | 130 | 7 | 8.5 | 18 | 20 | 60 | 10 |
| 0540 01 1011 | 10x11 | 150 | 8.5 | 9.3 | 20 | 22 | 75 | 10 |
| 0540 01 1012 | 10x12 | 150 | 8.5 | 9.3 | 20 | 22 | 75 | 10 |
| 0540 01 1113 | 11x13 | 170 | 9.3 | 10.8 | 22 | 25.5 | 105 | 10 |
| 0540 01 1214 | 12x14 | 170 | 9.3 | 10.8 | 22 | 25.5 | 105 | 10 |
| 0540 01 1719 | 17x19 | 210 | 11.8 | 13 | 30.5 | 33.5 | 185 | 10 |
| 0540 01 1922 | 19x22 | 230 | 12.8 | 14.9 | 33.5 | 39.5 | 235 | 10 |

0531

Double - Hex Starter and Block Wrench (SAE)

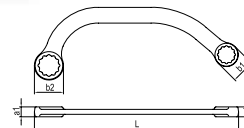

Chrom vanadium, Chrom plated

| CODE | inch | L mm | a1 mm | b1 mm | b2 mm | g | |
|--------------|------------|------|-------|-------|-------|-----|----|
| 0531 04 1112 | 7/16"x1/2" | 150 | 7 | 17 | 20 | 50 | 10 |
| 0531 04 1214 | 1/2"x9/16" | 185 | 9 | 21.5 | 26 | 110 | 10 |
| 0531 04 1416 | 9/16"x5/8" | 185 | 9 | 21.5 | 26 | 115 | 10 |
| 0531 04 1922 | 3/4"x7/8" | 230 | 11 | 29 | 33 | 195 | 10 |

SPECIAL SERIES (ask for quantity and delivery terms)

| | | | | | | | |
|--------------|--------------|-----|---|------|------|-----|----|
| 0531 04 0809 | 5/16"x3/8" | 120 | 6 | 12.5 | 15.5 | 30 | 10 |
| 0531 04 0911 | 3/8"x7/16" | 150 | 7 | 17 | 20 | 50 | 10 |
| 0531 04 1417 | 9/16"x11/16" | 185 | 9 | 21.5 | 26 | 110 | 10 |

Slugging Open Jaw Wrench (mm)

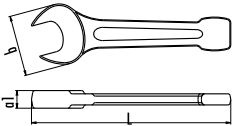
 TS 81
DIN 133

Chrom vanadium

| CODE | mm | L mm | a1 mm | b mm | g | |
|--------------|-----|------|-------|------|-------|---|
| 0700 05 0024 | 24 | 160 | 14 | 50 | 280 | 1 |
| 0700 05 0027 | 27 | 180 | 15 | 55 | 385 | 1 |
| 0700 05 0030 | 30 | 190 | 16 | 64 | 525 | 1 |
| 0700 05 0032 | 32 | 190 | 16 | 64 | 530 | 1 |
| 0700 05 0036 | 36 | 210 | 18 | 75 | 755 | 1 |
| 0700 05 0038 | 38 | 210 | 18 | 75 | 760 | 1 |
| 0700 05 0041 | 41 | 230 | 18 | 85 | 920 | 1 |
| 0700 05 0042 | 42 | 230 | 18 | 85 | 930 | 1 |
| 0700 05 0046 | 46 | 255 | 20 | 95 | 1305 | 1 |
| 0700 05 0047 | 47 | 255 | 20 | 95 | 1320 | 1 |
| 0700 05 0050 | 50 | 275 | 20 | 105 | 1565 | 1 |
| 0700 05 0055 | 55 | 310 | 23 | 119 | 2305 | 1 |
| 0700 05 0060 | 60 | 310 | 23 | 119 | 2310 | 1 |
| 0700 05 0065 | 65 | 340 | 28 | 135 | 3300 | 1 |
| 0700 05 0070 | 70 | 375 | 31 | 154 | 4555 | 1 |
| 0700 05 0075 | 75 | 375 | 31 | 154 | 4460 | 1 |
| 0700 05 0080 | 80 | 405 | 34 | 169 | 6115 | 1 |
| 0700 05 0085 | 85 | 405 | 34 | 169 | 5740 | 1 |
| 0700 05 0090 | 90 | 445 | 38 | 189 | 8040 | 1 |
| 0700 05 0095 | 95 | 445 | 38 | 189 | 8160 | 1 |
| 0700 05 0100 | 100 | 485 | 44 | 214 | 12355 | 1 |
| 0700 05 0105 | 105 | 485 | 44 | 214 | 11785 | 1 |
| 0700 05 0110 | 110 | 510 | 50 | 234 | 15000 | 1 |
| 0700 05 0115 | 115 | 510 | 50 | 234 | 14830 | 1 |
| 0700 05 0120 | 120 | 543 | 54 | 254 | 18865 | 1 |

SPECIAL SERIES (ask for quantity and delivery terms)

| | | | | | | |
|--------------|-----|-----|------|-----|-------|---|
| 0700 05 0125 | 125 | 543 | 54 | 254 | 17250 | 1 |
| 0700 05 0130 | 130 | 560 | 56 | 275 | 20000 | 1 |
| 0700 05 0135 | 135 | 560 | 56 | 275 | 19700 | 1 |
| 0700 05 0140 | 140 | 630 | 58.5 | 310 | 19400 | 1 |
| 0700 05 0145 | 145 | 630 | 58.5 | 310 | 28000 | 1 |
| 0700 05 0150 | 150 | 630 | 58.5 | 310 | 27600 | 1 |

Slugging Ring Wrench (mm)

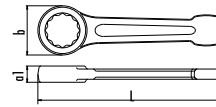
 TS 3794
DIN 7444

Chrom vanadium

| CODE | mm | L mm | a1 mm | b mm | g | |
|--------------|-----|------|-------|------|-------|---|
| 0750 05 0024 | 24 | 160 | 15 | 41.5 | 235 | 1 |
| 0750 05 0027 | 27 | 180 | 16 | 45.5 | 325 | 1 |
| 0750 05 0030 | 30 | 190 | 17 | 51 | 435 | 1 |
| 0750 05 0032 | 32 | 190 | 17 | 51 | 425 | 1 |
| 0750 05 0036 | 36 | 205 | 19 | 58 | 550 | 1 |
| 0750 05 0038 | 38 | 205 | 19 | 58 | 530 | 1 |
| 0750 05 0041 | 41 | 225 | 20 | 63 | 730 | 1 |
| 0750 05 0042 | 42 | 225 | 20 | 63 | 700 | 1 |
| 0750 05 0046 | 46 | 240 | 22 | 71 | 970 | 1 |
| 0750 05 0047 | 47 | 240 | 22 | 71 | 930 | 1 |
| 0750 05 0050 | 50 | 255 | 23 | 77 | 1160 | 1 |
| 0750 05 0055 | 55 | 272 | 25 | 88 | 1520 | 1 |
| 0750 05 0060 | 60 | 272 | 25 | 88 | 1460 | 1 |
| 0750 05 0065 | 65 | 300 | 28 | 98 | 2025 | 1 |
| 0750 05 0070 | 70 | 330 | 32 | 108 | 2890 | 1 |
| 0750 05 0075 | 75 | 330 | 32 | 108 | 2755 | 1 |
| 0750 05 0080 | 80 | 360 | 35 | 126 | 4000 | 1 |
| 0750 05 0085 | 85 | 360 | 35 | 126 | 3620 | 1 |
| 0750 05 0090 | 90 | 390 | 40 | 140 | 5465 | 1 |
| 0750 05 0095 | 95 | 390 | 40 | 140 | 5250 | 1 |
| 0750 05 0100 | 100 | 420 | 44 | 148 | 6755 | 1 |
| 0750 05 0105 | 105 | 420 | 44 | 148 | 6445 | 1 |
| 0750 05 0110 | 110 | 450 | 48 | 166 | 8500 | 1 |
| 0750 05 0115 | 115 | 450 | 48 | 166 | 8460 | 1 |
| 0750 05 0120 | 120 | 490 | 54 | 178 | 10000 | 1 |

SPECIAL SERIES (ask for quantity and delivery terms)

| | | | | | | |
|--------------|-----|-----|------|-----|-------|---|
| 0750 05 0125 | 125 | 490 | 54 | 178 | 9900 | 1 |
| 0750 05 0130 | 130 | 518 | 59 | 196 | 16000 | 1 |
| 0750 05 0135 | 135 | 518 | 59 | 196 | 15900 | 1 |
| 0750 05 0140 | 140 | 518 | 59 | 196 | 15800 | 1 |
| 0750 05 0145 | 145 | 580 | 61.8 | 223 | 22000 | 1 |
| 0750 05 0150 | 150 | 580 | 61.8 | 223 | 21900 | 1 |
| 0750 05 0155 | 155 | 580 | 61.8 | 223 | 21800 | 1 |
| 0750 05 0160 | 160 | 580 | 61.8 | 223 | 21700 | 1 |
| 0750 05 0165 | 165 | 648 | 67 | 262 | 30000 | 1 |
| 0750 05 0170 | 170 | 648 | 67 | 262 | 29800 | 1 |
| 0750 05 0180 | 180 | 648 | 67 | 262 | 29700 | 1 |

0550

Offset Ring Wrench (mm)

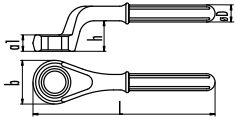

Chrom vanadium, Chrom plated

| CODE | mm | L mm | a1 mm | b mm | σD mm | h mm | g | |
|--------------|----|------|-------|------|-------|------|------|---|
| 0550 05 0024 | 24 | 180 | 17 | 37 | 18.5 | 30 | 400 | 1 |
| 0550 05 0027 | 27 | 190 | 18 | 42 | 18.5 | 33 | 450 | 1 |
| 0550 05 0030 | 30 | 200 | 20 | 46 | 18.5 | 34 | 520 | 1 |
| 0550 05 0032 | 32 | 235 | 21.5 | 49 | 21.2 | 37 | 700 | 1 |
| 0550 05 0036 | 36 | 245 | 23 | 53.5 | 21.2 | 42 | 830 | 1 |
| 0550 05 0038 | 38 | 270 | 25 | 60.5 | 21.2 | 43 | 965 | 1 |
| 0550 05 0041 | 41 | 270 | 25 | 60.5 | 21.2 | 43 | 950 | 1 |
| 0550 05 0046 | 46 | 280 | 26 | 68 | 24.2 | 45 | 1240 | 1 |
| 0550 05 0050 | 50 | 290 | 28 | 74 | 24.2 | 47 | 1410 | 1 |
| 0550 05 0055 | 55 | 300 | 30 | 79 | 24.2 | 50 | 1550 | 1 |
| 0550 05 0060 | 60 | 345 | 32 | 89 | 29 | 50.5 | 2390 | 1 |
| 0550 05 0065 | 65 | 355 | 34 | 98 | 29 | 56.5 | 2730 | 1 |

SPECIAL SERIES (ask for quantity and delivery terms)

| | | | | | | | | |
|--------------|-----|-----|------|-----|------|------|------|---|
| 0550 05 0022 | 22 | 180 | 17 | 37 | 18.5 | 30 | 400 | 1 |
| 0550 05 0034 | 34 | 235 | 21.5 | 49 | 21.2 | 37 | 750 | 1 |
| 0550 05 0070 | 70 | 365 | 37 | 104 | 29 | 55 | 2900 | 1 |
| 0550 05 0075 | 75 | 375 | 40 | 109 | 29 | 57.5 | 3100 | 1 |
| 0550 05 0080 | 80 | 385 | 43 | 124 | 29 | 59 | 3900 | 1 |
| 0550 05 0085 | 85 | 385 | 43 | 124 | 29 | 59 | 3750 | 1 |
| 0550 05 0090 | 90 | 410 | 46 | 140 | 29 | 63 | 5100 | 1 |
| 0550 05 0095 | 95 | 410 | 46 | 140 | 29 | 63 | 4950 | 1 |
| 0550 05 0100 | 100 | 420 | 46 | 150 | 29 | 65 | 4800 | 1 |

0551

Tubular Handle



Seamless Steel Pipe

| CODE | mm | L mm | σ mm | g | |
|--------------|----------|------|------|------|---|
| 0551 05 0001 | 22 - 30 | 460 | 25 | 700 | 1 |
| 0551 05 0002 | 32 - 41 | 610 | 27 | 1220 | 1 |
| 0551 05 0003 | 46 - 55 | 760 | 32.2 | 1880 | 1 |
| 0551 05 0004 | 60 - 100 | 860 | 38 | 2975 | 1 |

0600

Adjustable Wrench

TS ISO 6787



Spare parts page 228



IZELTAS YOUTUBE

Chrom vanadium, Chrom plated, PVC insulated

| CODE | L mm | L inch | a mm | g | |
|--------------|------|--------|------|-----|---|
| 0600 01 1006 | 160 | 6" | 18 | 120 | 5 |
| 0600 01 1008 | 208 | 8" | 23 | 230 | 5 |
| 0600 01 1010 | 260 | 10" | 28 | 400 | 5 |
| 0600 01 1012 | 308 | 12" | 34 | 670 | 5 |

0600 01 0010

Insulated Electrician Type Adjustable Wrench 1000V

TS ISO 6787
 ⚡ 1000 V / IEC 60900



Spare parts page 228

Chrom vanadium, Chrom plated, Triple PVC insulated

| CODE | L mm | L inch | a mm | g | |
|--------------|------|--------|------|-----|---|
| 0600 01 0010 | 260 | 10" | 28 | 440 | 5 |

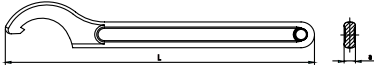

Chrom vanadium, Chrom plated

| CODE | mm | L mm | a1 mm | g | |
|--------------|--------|------|-------|-----|----|
| 0860 05 2528 | 25/28 | 136 | 4 | 50 | 10 |
| 0860 05 3032 | 30/32 | 136 | 4 | 50 | 10 |
| 0860 05 3436 | 34/36 | 171 | 5 | 95 | 10 |
| 0860 05 4042 | 40/42 | 171 | 5 | 95 | 10 |
| 0860 05 4550 | 45/50 | 210 | 6 | 160 | 10 |
| 0860 05 5255 | 52/55 | 210 | 6 | 160 | 10 |
| 0860 05 5862 | 58/62 | 242 | 7 | 270 | 5 |
| 0860 05 6875 | 68/75 | 242 | 7 | 270 | 5 |
| 0860 05 8090 | 80/90 | 281 | 8 | 400 | 5 |
| 0860 05 9510 | 95/100 | 281 | 8 | 400 | 5 |

0615 01 0200

Adjustable Speed Wrench

 İZELTAS USTA İŞİ
SOHBETLER

Chrom vanadium, Chrom plated

Spare parts page 223

| CODE | L mm | L inch | a mm | g | |
|----------------|------|--------|------|-----|---|
| ★ 0615 01 0200 | 200 | 8" | 6-22 | 220 | 5 |

Allows to open bolts with different geometry such as Hexagon, Torx, XZN, Ribe, Square in sizes from 6 to 22 mm. Enables unbolting and tightening turn without removing the wrench completely from the bolt head. Specially opened 10-13-15 mm holes on the handle, allows to open hexagon bolts.



★ It is limited by stocks

MCD MULTI CONTACT DRIVE PROFILE



IZELTAS New Generation Ring Wrench Profile

MCD (Multi Contact Drive) is designed to improve the driving performance of the ring wrench. MCD, designed through computer aided drafting, transmits more torque and has longer life than conventional 12 edge ring profile.

Multi point contact is the source of effectiveness, where maximum surface area is in touch with fastener flats. Increased contact also maximizes tool's life through decreased pressure on the contact points.

- ☛ New profile of the ring wrench is formed of curves. Torque is transmitted through these curves rather than edges. As the stress is balanced between enlarged surfaces, the risk of deformation is minimized.

- ☛ It is possible to drive off-tolerance fasteners.
- ☛ Does not deform the fastener edges.
- ☛ Larger contact area increases tool's life.
- ☛ Works well with deformed fasteners.

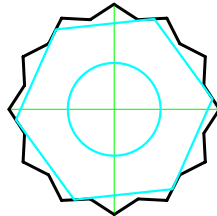

Multi Point Contact

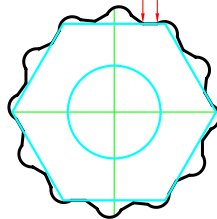

MCD Profile

SPEED WRENCH



Longer Tool Life

This new speed wrench profile contacts the fasteners from their flats rather than edges, which provides balanced torque transmission and decreases stress accumulation on the edges increasing the tool life considerably.

- ☛ Fast drive without removing the wrench from the fastener.
- ☛ Firm torque transmission and longer life.

100% Faster

New designed speed wrench takes its 100% faster rotational drive from the ratchet mechanism principle. Rotating the tool without the need for removing from the fastener provides faster usage, while enabling safer and slip-free usage with fully gripping upper and lower jaws.





SOCKETS AND RIM WRENCHES

Socket Wrenches

Socket Wrench Sets

Tubular Socket Wrenches

Rim Wrenches

Torque Wrenches



Torque (Moment) and Force

- » As you know, force is the effect which imparts movement to an object. Torque, is rotation of an object under effect of force. Various hand tools like a Philips head screwdriver, for spanner or socket wrench are used to tighten connection elements. While this process appears functional and correct, it is not an appropriate procedure for reliability of the threaded connection. The greatest safety of a threaded connection against loosening is being tightened at a certain torque level theoretically calculated beforehand. This can only be ensured with various modern methods. For example, tightening with a torque wrench, motor-driven tightening or ultrasound supported tightening. Various applications have shown that use of a torque wrench is more appropriate.



What Is Tightening Torque ?

- » Tightening torque is generated at the wrench tip at the terminus of the rotating lever under the effect of force, and its unit is Nm. This tightening torque creates a pre-tension on the threaded connection. Tightening torque being lower than what is necessary can cause the threaded connection to loosen/unravel due to vibrations that might occur over time. On the other hand, pre-tension force being over what is necessary can cause damage on the connection parts, as well as causing the threads on the connection piece to wear off or causing the connection become non-severable.

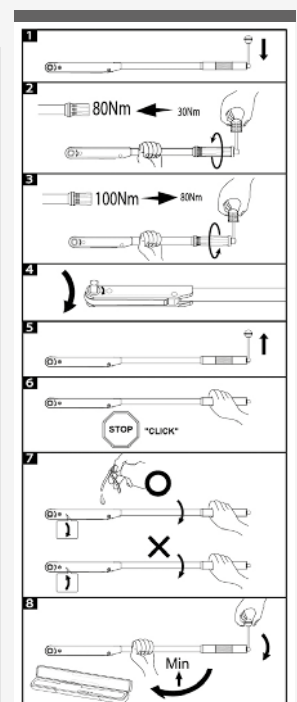



Correct Use Of Torque Wrenches

» There are some important points that must be kept in mind when working with a torque wrench. Some of these include the following.

- No matter which type of torque wrench is used, force should not be applied at the opposite of rotating direction.
- Torque wrenches like ratchet wrenches should not be used to loosen connections.
- In models with click sound option, the click indicates the set torque value is achieved and further force should not be applied from then on.
- Do not continue using torque wrenches with a damaged body or mechanism.
- Force should be applied at the handle part of the torque wrench.
- The tool should always be kept in its box after use to protect against moisture and dirt.
- The load set of the torque wrench should be adjusted to "0 Nm" after each use.
- Please do not attempt to repair torque wrenches on your own.

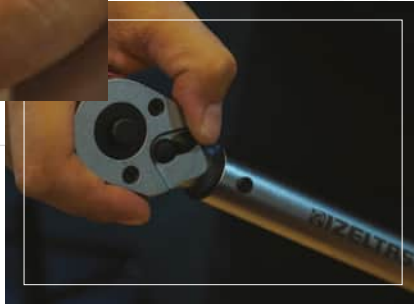

Calibration Of Torque Wrenches

» Calibration process carries great importance for torque wrenches to function correctly and be able to tighten connections in a healthy fashion. TS EN ISO 6789-1 Standard stipulates torque wrenches should be calibrated with 12 month periods or after each cycle of 5000 uses starting from the first use.

SOCKET WRENCH 6 POINTS

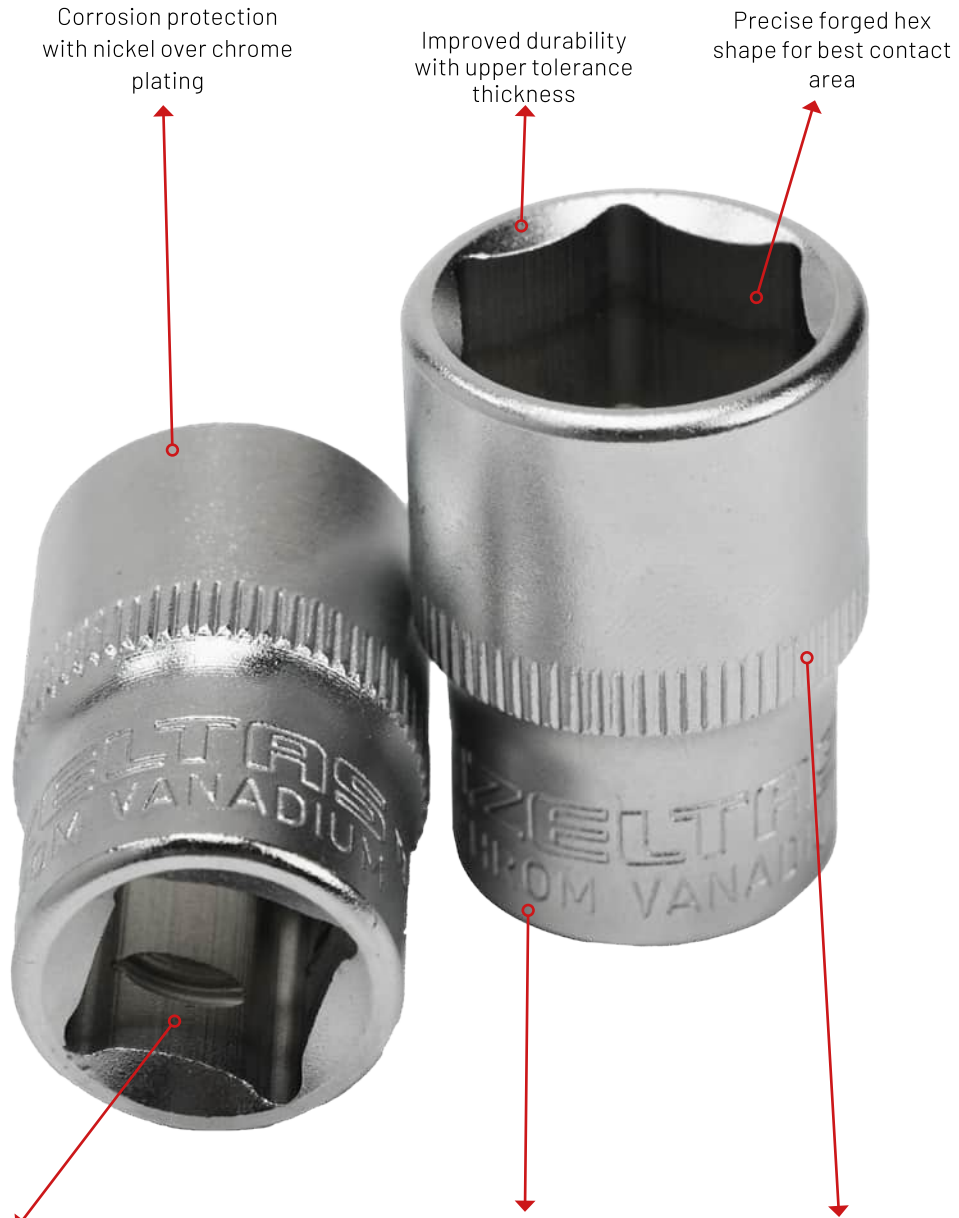

Corrosion protection with nickel over chrome plating

Improved durability with upper tolerance thickness

Precise forged hex shape for best contact area

Precise machined square adapter with ball stopper Groove

High strength alloyed forged steel

Extra friction capability with knurled design



IZELTAS YOUTUBE

1107

Socket Wrench 6 Points (mm)

TS ISO 2725 -1
DIN 3124

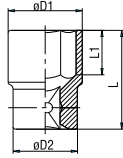

Chrom plated

| CODE | mm | ø D1 mm | ø D2 mm | L mm | L1 mm | g | |
|--------------|-----|---------|---------|------|-------|----|----|
| 1107 06 0004 | 4 | 6.8 | 11.8 | 25 | 4 | 10 | 10 |
| 1107 06 0045 | 4.5 | 7.4 | 11.8 | 25 | 5 | 10 | 10 |
| 1107 06 0005 | 5 | 8 | 11.8 | 25 | 6 | 10 | 10 |
| 1107 06 0055 | 5.5 | 8.5 | 11.8 | 25 | 6 | 10 | 10 |
| 1107 06 0006 | 6 | 9.2 | 11.8 | 25 | 7 | 10 | 10 |
| 1107 06 0007 | 7 | 10.8 | 11.8 | 25 | 7 | 10 | 10 |
| 1107 06 0008 | 8 | 11.9 | 11.8 | 25 | 8 | 10 | 10 |
| 1107 06 0009 | 9 | 12.9 | 12.8 | 25 | 8 | 15 | 10 |
| 1107 06 0010 | 10 | 14.3 | 14.3 | 25 | 9 | 20 | 10 |
| 1107 06 0011 | 11 | 15.8 | 15.8 | 25 | 9 | 20 | 10 |
| 1107 06 0012 | 12 | 16.8 | 16.8 | 25 | 9 | 25 | 10 |
| 1107 06 0013 | 13 | 17.8 | 17.8 | 25 | 9 | 30 | 10 |

1107

Deep Socket Wrench 6 Points (mm)

TS ISO 2725 -1

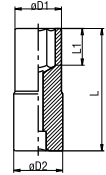

Chrom Plated

| CODE | mm | ø D1 mm | ø D2 mm | L mm | L1 mm | g | |
|--------------|-----|---------|---------|------|-------|----|----|
| 1107 06 4004 | 4 | 6.8 | 11.8 | 50 | 6 | 10 | 10 |
| 1107 06 4005 | 5 | 8 | 11.8 | 50 | 7 | 20 | 10 |
| 1107 06 4055 | 5.5 | 8.7 | 11.8 | 50 | 9 | 20 | 10 |
| 1107 06 4006 | 6 | 9.2 | 11.8 | 50 | 9 | 25 | 10 |
| 1107 06 4007 | 7 | 10.8 | 11.8 | 50 | 15 | 25 | 10 |
| 1107 06 4008 | 8 | 11.8 | 11.8 | 50 | 15 | 25 | 10 |
| 1107 06 4009 | 9 | 13 | 13 | 50 | 15 | 30 | 10 |
| 1107 06 4010 | 10 | 14.5 | 14.5 | 50 | 15 | 40 | 10 |
| 1107 06 4011 | 11 | 15.8 | 15.8 | 50 | 21 | 45 | 10 |
| 1107 06 4012 | 12 | 16.8 | 16.8 | 50 | 21 | 50 | 10 |
| 1107 06 4013 | 13 | 17.8 | 17.8 | 50 | 21 | 55 | 10 |

1107 00 6014

Deep Socket Wrench Set Type 6 Points (14 pcs, mm)



| CODE | Sockets | Accessories | g | |
|--------------|-----------------------------------|----------------------|------|----|
| 1107 00 6014 | 4-5-5,5-6 7-8-9-10 11-12-13 | Ratchet Handle | 1005 | 14 |
| | Deep Socket Wrench 6 Points | Extension Bar 50 mm | | |
| | | Extension Bar 100 mm | | |



Do not use with power-tools

1107

Hexagonal Bit
Socket Wrench



1/4"

Chrom Plated

| CODE | mm | L mm | g | |
|--------------|-----|------|----|----|
| 1107 06 1125 | 2.5 | 37 | 13 | 10 |
| 1107 06 1103 | 3 | 37 | 13 | 10 |
| 1107 06 1104 | 4 | 37 | 15 | 10 |
| 1107 06 1105 | 5 | 37 | 15 | 10 |
| 1107 06 1106 | 6 | 37 | 15 | 10 |
| 1107 06 1107 | 7 | 37 | 16 | 10 |
| 1107 06 1108 | 8 | 37 | 17 | 10 |
| 1107 06 1110 | 10 | 37 | 19 | 10 |

1107

Tamper ResistantTorx
Bit Socket Wrench



1/4"

Chrom Plated

| CODE | | L mm | g | |
|--------------|------|------|----|----|
| 1107 06 1308 | TR8 | 37 | 13 | 10 |
| 1107 06 1309 | TR9 | 37 | 13 | 10 |
| 1107 06 1310 | TR10 | 37 | 13 | 10 |
| 1107 06 1315 | TR15 | 37 | 14 | 10 |
| 1107 06 1320 | TR20 | 37 | 14 | 10 |
| 1107 06 1325 | TR25 | 37 | 14 | 10 |
| 1107 06 1327 | TR27 | 37 | 14 | 10 |
| 1107 06 1330 | TR30 | 37 | 15 | 10 |
| 1107 06 1340 | TR40 | 37 | 16 | 10 |

1107

Torx Bit Socket Wrench



1/4"

Chrom Plated

| CODE | | L mm | g | |
|--------------|-----|------|----|----|
| 1107 06 1208 | T8 | 37 | 12 | 10 |
| 1107 06 1209 | T9 | 37 | 12 | 10 |
| 1107 06 1210 | T10 | 37 | 13 | 10 |
| 1107 06 1215 | T15 | 37 | 14 | 10 |
| 1107 06 1220 | T20 | 37 | 14 | 10 |
| 1107 06 1225 | T25 | 37 | 14 | 10 |
| 1107 06 1227 | T27 | 37 | 14 | 10 |
| 1107 06 1230 | T30 | 37 | 15 | 10 |
| 1107 06 1240 | T40 | 37 | 16 | 10 |

1107

Slotted Bit Socket Wrench



1/4"

Chrom Plated

| CODE | | L mm | g | |
|--------------|-----|------|----|----|
| 1107 06 1403 | 3 | 37 | 13 | 10 |
| 1107 06 1435 | 3.5 | 37 | 14 | 10 |
| 1107 06 1404 | 4 | 37 | 14 | 10 |
| 1107 06 1445 | 4.5 | 37 | 14 | 10 |
| 1107 06 1455 | 5.5 | 37 | 15 | 10 |
| 1107 06 1465 | 6.5 | 37 | 15 | 10 |
| 1107 06 1407 | 7 | 37 | 16 | 10 |
| 1107 06 1408 | 8 | 37 | 16 | 10 |
| 1107 06 1410 | 10 | 37 | 17 | 10 |

1107

Phillips Bit Socket Wrench



1/4"

, Chrom Plated

| CODE | + | L mm | g | □ |
|--------------|------|------|----|----|
| 1107 06 1501 | Ph 1 | 37 | 14 | 10 |
| 1107 06 1502 | Ph 2 | 37 | 14 | 10 |
| 1107 06 1503 | Ph 3 | 37 | 15 | 10 |
| 1107 06 1504 | Ph 4 | 37 | 16 | 10 |

1107 00 1042

Bit Socket Wrench Set (42 Pcs)



1/4"

| CODE | CONTENTS | □ |
|--------------|--|----|
| 1107 00 1042 | Torx® Bit Socket T8-T9-T10-T15-T20-T25-T27-T30-T40 | 42 |
| | Tamper Resistant Torx® Bit Socket Wrench TR8-TR9-TR10-TR15-TR20-TR25-TR27-TR30-TR40 | |
| | Hexagonal Bit Socket Wrench 2.5-3-4-5-6-7-8-10 | |
| | Slotted Bit Socket Wrench 3-3.5-4-4.5-5.5-6.5-7-8-10 | |
| | Phillips Bit Socket Wrench Ph1-Ph2-Ph3-Ph4 | |
| | Ratchet Handle | |
| | Extension Bar 100 mm | |
| | Spindle Handle | |

Do not use with power-tools

1507

Extension Bar

DIN 3123



1/4"

Chrom plated

| CODE | L mm | g | □ |
|--------------|------|----|---|
| 1507 06 0050 | 50 | 25 | 5 |
| 1507 06 0100 | 100 | 45 | 5 |

1507 06 3150

Flexible Extension



1/4"

Chrom plated

| CODE | L mm | g | □ |
|--------------|------|----|---|
| 1507 06 3150 | 150 | 70 | 5 |

1507 06 0038

TS ISO 3316

Universal Joint



1/4"

Chrom plated

| CODE | L mm | g | □ |
|--------------|------|----|---|
| 1507 06 0038 | 38 | 25 | 5 |

1507 06 4115

TS ISO 3315
DIN 3122

Sliding T - Handle



1/4"

Chrom plated

| CODE | L mm | g | □ |
|--------------|------|----|---|
| 1507 06 4115 | 115 | 45 | 5 |

1507 06 2140

TS ISO 3315

Ratchet Handle (45 Teeth)



1/4"

Chrom plated

| CODE | L mm | g | □ |
|--------------|------|-----|---|
| 1507 06 2140 | 140 | 140 | 5 |

1507 06 6140

TS ISO 3315

Ratchet With Latch (24 Teeth)



1/4"

Chrom plated

| CODE | L mm | g | □ |
|--------------|------|-----|---|
| 1507 06 6140 | 140 | 140 | 5 |

1507 06 2150

Swivel Head Ratchet (72 Teeth)



1/4"

Chrom plated

| CODE | L mm | g | □ |
|----------------|------|-----|---|
| ★ 1507 06 2150 | 150 | 130 | 5 |

1507 06 2110

Socket/Bit Holder mini Ratchet (72 Teeth)



1/4"

Chrom plated

| CODE | L mm | g | □ |
|----------------|------|-----|---|
| ★ 1507 06 2110 | 110 | 100 | 5 |

1507 06 7115

Swivel Head, T Handle Ratchet (72 Teeth)

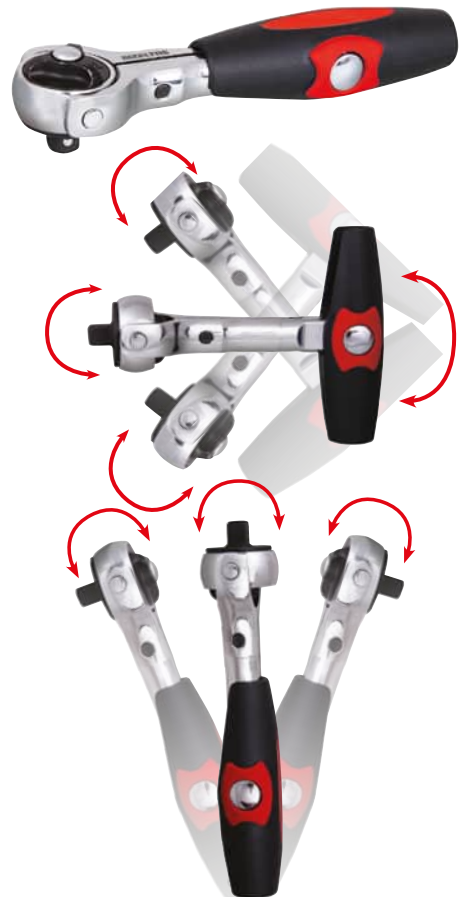

1/4"

Chrom plated

| CODE | L mm | g | □ |
|----------------|------|-----|---|
| ★ 1507 06 7115 | 115 | 110 | 5 |

★ It is limited by stocks

Do not use with power-tools

1507 06 0004

Adapter

TS ISO 3316
DIN 3123



1/4"

Chrom vanadium, Chrom plated

| CODE | inch | g | |
|--------------|-------------|----|---|
| 1507 06 0004 | 1/4"Fx3/8"M | 20 | 5 |

1507 06 4080

Spindle Handle

TS ISO 3315
DIN 3122

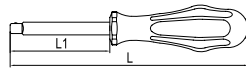

1/4"

Chrom plated, Cellulose Acetate Handle

| CODE | L mm | L1 mm | g | |
|--------------|------|-------|-----|----|
| 1507 06 4080 | 150 | 65 | 100 | 10 |

1107 06 5010

Bit Holder Socket



1/4"

Chrom vanadium

| CODE | Inch | g | |
|--------------|-----------------|----|---|
| 1107 06 5010 | 1/4" F - 1/4" F | 15 | 5 |

1107 00 6015

Socket Wrench Set 6 Points (15 pcs, mm)



1/4"

| CODE | Sockets | Accessories | g | |
|--------------|---|-----------------------------------|-----|----|
| 1107 00 6015 | | Ratchet Handle | | |
| | 4 - 5 - 6 7 - 8 - 9 - 10 11 - 12 - 13 | Universal Joint | | |
| | Six Points | Sliding T Handle | 960 | 15 |
| | | Bar 50 mm Extension Bar 100 mm | | |

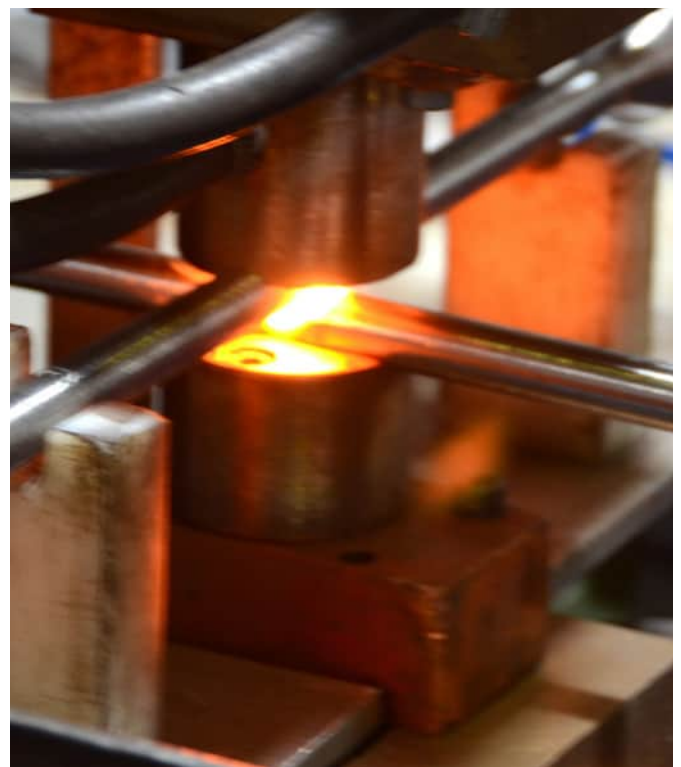

Do not use with power-tools

14000 005131

Socket Wrench 6 Points and Bits Set (48 Pcs, mm)



| CODE | Sockets | Accessories | g | |
|--------------|------------------|--|------|----|
| 14000 005131 | 4 - 4.5 - 5 | Ratchet Handle | 1450 | 48 |
| | 5.5 - 6 - 7 - 8 | Universal Joint | | |
| | 9 - 10 - 11 - 12 | | | |
| | 13 - 14 | | | |
| | Six Points | Extension Bar 50 -100 mm | | |
| 14000 005131 | 4 - 4.5 - 5 | Bits Holder Socket | 1450 | 48 |
| | 5.5 - 6 - 7 - 8 | | | |
| | 9 - 10 - 11 - 12 | | | |
| | 13 - 14 | | | |
| | Six Points Deep | Spindle Handle | | |
| | | <ul style="list-style-type: none"> SL3 - SL4,5 - SL5 SL6,5 - SL8 PH0 - PH1 - PH2 PH3 H3 - H4 - H5 - H6 H7 - H8 - H10 | | |

14000 005132

Socket Wrench 6 Points and Bits Set (27 Pcs, mm)



| CODE | Sockets | Accessories | g | |
|--------------|-----------------|---|-----|----|
| 14000 005132 | 4 - 4.5 - 5 | Ratchet Handle | 590 | 27 |
| | 5.5 - 6 - 7 - 8 | Universal Joint | | |
| | 9 - 10 - 12 | | | |
| | 13 - 14 | | | |
| | Six Points | Extension Bar 100 mm | | |
| 14000 005132 | 4 - 4.5 - 5 | Bits Holder Socket | 590 | 27 |
| | 5.5 - 6 - 7 - 8 | | | |
| | 9 - 10 - 12 | | | |
| | 13 - 14 | | | |
| | Six Points | Spindle Handle | | |
| | | <ul style="list-style-type: none"> PH1 - PH2 H3 - H4 - H5 T10 - T15 - T20 T25 - T30 - T40 | | |

14000 005133

Socket Wrench 6 Points and Bits Set (45 Pcs, mm)



| CODE | Sockets | Accessories | g | |
|--------------|------------------|--|------|----|
| 14000 005133 | 4 - 5 | Ratchet Handle | 1000 | 45 |
| | 5.5 - 6 - 7 - 8 | Universal Joint | | |
| | 9 - 10 - 11 - 12 | | | |
| | 13 - 14 | | | |
| | Six Points | Extension Bar 50 mm | | |
| 14000 005133 | 4 - 5 | Bits Holder Socket | 1000 | 45 |
| | 5.5 - 6 - 7 - 8 | | | |
| | 9 - 10 - 11 - 12 | | | |
| | 13 - 14 | | | |
| | Six Points | Tornavida Adaptörü Spindle Handle | | |
| | | <ul style="list-style-type: none"> SL4.5 - SL6.5 SL7 - SL8 PH1 - PH2 - PH3 PZ1 - PZ2 - PZ3 H2.5 - H3 - H4 - H5 H6 - H7 - H8 - H10 T8U - T9U - T10U T15U - T20U - T25U T27U - T30U - T40U | | |

Do not use with power-tools

1110

Socket Wrench 6 Points (mm)

TS ISO 2725 - 1
DIN 3124

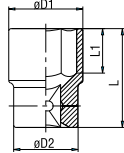

Chrom vanadium,

| CODE | mm | ø D1 mm | ø D2 mm | L mm | L1 mm | g | |
|--------------|----|---------|---------|------|-------|----|----|
| 1110 06 0006 | 6 | 9.8 | 17.8 | 27 | 9 | 25 | 10 |
| 1110 06 0007 | 7 | 10.8 | 17.8 | 27 | 9 | 25 | 10 |
| 1110 06 0008 | 8 | 12 | 17.8 | 27 | 9 | 25 | 10 |
| 1110 06 0009 | 9 | 13.2 | 17.8 | 27 | 9 | 25 | 10 |
| 1110 06 0010 | 10 | 14.5 | 17.8 | 27 | 9 | 25 | 10 |
| 1110 06 0011 | 11 | 15.8 | 17.8 | 27 | 9 | 30 | 10 |
| 1110 06 0012 | 12 | 16.8 | 17.8 | 27 | 9 | 30 | 10 |
| 1110 06 0013 | 13 | 17.8 | 16.8 | 27 | 9 | 30 | 10 |
| 1110 06 0014 | 14 | 19.6 | 17.5 | 29 | 11 | 35 | 10 |
| 1110 06 0015 | 15 | 20.8 | 18 | 29 | 11 | 45 | 10 |
| 1110 06 0016 | 16 | 21.8 | 19 | 29 | 11 | 45 | 10 |
| 1110 06 0017 | 17 | 23.4 | 20 | 29 | 11 | 55 | 10 |
| 1110 06 0018 | 18 | 24.7 | 21 | 29 | 13 | 60 | 10 |
| 1110 06 0019 | 19 | 25.8 | 22 | 29 | 13 | 65 | 10 |
| 1110 06 0021 | 21 | 27.8 | 24 | 32 | 13 | 80 | 10 |
| 1110 06 0022 | 22 | 29.7 | 26 | 32 | 15 | 85 | 10 |
| 1110 06 0023 | 23 | 29.7 | 26 | 32 | 15 | 90 | 10 |

1110 06 9208

Spark Plug Socket with Rubber



Chrom plated

| CODE | mm | L mm | g | |
|--------------|------|------|-----|----|
| 1110 06 9208 | 20.8 | 70 | 145 | 10 |

TS ISO 2725 - 1
DIN 3124

Deep Socket Wrench 6 Points (mm)

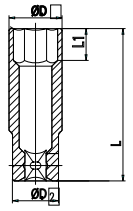

Chrom vanadium,

| CODE | mm | ø D1 mm | ø D2 mm | L mm | L1 mm | g | |
|--------------|----|---------|---------|------|-------|-----|----|
| 14000 004965 | 6 | 9.9 | 17.8 | 63 | 10 | 50 | 10 |
| 14000 004966 | 7 | 10.8 | 17.8 | 63 | 12 | 50 | 10 |
| 14000 004967 | 8 | 12 | 17.8 | 63 | 12 | 50 | 10 |
| 14000 004968 | 9 | 13.2 | 17.8 | 63 | 12 | 55 | 10 |
| 14000 004969 | 10 | 14.5 | 17.8 | 63 | 12 | 60 | 10 |
| 14000 004970 | 11 | 15.8 | 17.8 | 63 | 15 | 60 | 10 |
| 14000 004971 | 12 | 16.8 | 17.8 | 63 | 15 | 70 | 10 |
| 14000 004972 | 13 | 17.8 | 16.8 | 63 | 15 | 65 | 10 |
| 14000 004973 | 14 | 19.7 | 18 | 63 | 16 | 80 | 10 |
| 14000 004974 | 15 | 20.8 | 18 | 63 | 18 | 75 | 10 |
| 14000 004975 | 16 | 21.8 | 19 | 63 | 18 | 85 | 10 |
| 14000 004976 | 17 | 23.8 | 20 | 63 | 18 | 100 | 10 |
| 14000 004977 | 18 | 24.7 | 21 | 63 | 20 | 110 | 10 |
| 14000 004978 | 19 | 25.8 | 21 | 63 | 20 | 110 | 10 |
| 14000 004980 | 21 | 27.8 | 25 | 63 | 20 | 140 | 10 |
| 14000 004981 | 22 | 29.7 | 26 | 63 | 20 | 170 | 10 |

Star Torx® Socket Wrench

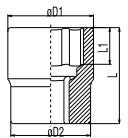

Chrom plated

| CODE | | ø D1 mm | ø D2 mm | L mm | L1 mm | g | |
|--------------|-----|---------|---------|------|-------|----|----|
| 14000 005001 | E4 | 6 | 16.8 | 28 | 3.6 | 20 | 10 |
| 14000 005002 | E5 | 7 | 16.8 | 28 | 4 | 20 | 10 |
| 14000 005003 | E6 | 8 | 16.8 | 28 | 5 | 20 | 10 |
| 14000 005004 | E7 | 9 | 16.8 | 28 | 6 | 20 | 10 |
| 14000 005005 | E8 | 10 | 16.8 | 28 | 6.5 | 25 | 10 |
| 14000 005006 | E10 | 12 | 16.8 | 28 | 7 | 25 | 10 |
| 14000 005007 | E11 | 12.8 | 16.8 | 28 | 8 | 25 | 10 |
| 14000 005008 | E12 | 14.3 | 16.8 | 28 | 9 | 25 | 10 |
| 14000 005009 | E14 | 15.9 | 17.8 | 28 | 9.5 | 30 | 10 |
| 14000 005010 | E16 | 18 | 19.8 | 28 | 10.5 | 40 | 10 |
| 14000 005011 | E18 | 20 | 21.8 | 28 | 11 | 55 | 10 |

1510 06 0200

Hexagonal Bits Socket Wrench



Chrom plated

| CODE | mm | L mm | g | |
|--------------|----|------|----|----|
| 14000 004993 | 3 | 50 | 30 | 10 |
| 14000 004994 | 4 | 50 | 35 | 10 |
| 14000 004995 | 5 | 50 | 35 | 10 |
| 14000 004996 | 6 | 50 | 35 | 10 |
| 14000 004997 | 7 | 50 | 40 | 10 |
| 14000 004998 | 8 | 50 | 40 | 10 |
| 14000 004999 | 9 | 50 | 45 | 10 |
| 14000 005000 | 10 | 50 | 50 | 10 |

Ratchet Handle (32 Teeth)

TS ISO 3315
DIN 3122



3/8"

Chrom plated

| CODE | L mm | g | |
|--------------|------|-----|---|
| 1510 06 0200 | 200 | 295 | 5 |

1510

3/8" Ara Kol
Extension Bar

TS ISO 3316
DIN 3123



3/8"

Chrom plated

| CODE | L mm | g | |
|--------------|------|-----|---|
| 1510 06 0075 | 75 | 75 | 5 |
| 1510 06 0150 | 150 | 145 | 5 |

Star Torx® Bits Socket Wrench



Chrom plated

| CODE | | L mm | g | |
|--------------|-----|------|----|----|
| 14000 004983 | T8 | 50 | 30 | 10 |
| 14000 004984 | T9 | 50 | 30 | 10 |
| 14000 004985 | T10 | 50 | 35 | 10 |
| 14000 004986 | T15 | 50 | 35 | 10 |
| 14000 004987 | T20 | 50 | 35 | 10 |
| 14000 004988 | T25 | 50 | 35 | 10 |
| 14000 004989 | T27 | 50 | 35 | 10 |
| 14000 004990 | T30 | 50 | 35 | 10 |
| 14000 004991 | T40 | 50 | 35 | 10 |
| 14000 004992 | T45 | 50 | 40 | 10 |

1510 06 0056

Universal Joint

TS ISO 3316
DIN 3123



3/8"

Chrom plated

| CODE | L mm | g | |
|--------------|------|----|---|
| 1510 06 0056 | 56.5 | 60 | 5 |

1510 06 1200

Sliding T - Handle

TS ISO 3315
DIN 3122



3/8"

Chrom plated

| CODE | L mm | g | |
|--------------|---------|-----|---|
| 1510 06 1200 | 200 | 180 | 5 |

1510 06 0007

Adapter

DIN 3123



3/8"

, Chrom plated

| CODE | inch | g | |
|--------------|-------------|----|---|
| 1510 06 0007 | 3/8"Fx1/2"M | 45 | 5 |

1110 00 6019

6 Points Socket Wrench Set (19 Pcs, mm)



3/8"



| CODE | Sockets | Accessories | g | |
|--------------|---|-------------------------|------|----|
| 1110 00 6019 | 6 - 7 - 8 - 9 10 - 11 - 12 13 - 14 - 17 19 - 21 - 23 | Ratchet Handle | 1089 | 19 |
| | Altı Köşe Six Points | Universal Joint | | |
| | 20.8 | Sliding T Handle | | |
| | Spark Plug Socket With Rubber | Extension Bar 75 mm | | |
| | | Extension Bar 150 mm | | |

14000 005134

Socket Wrench Set 6 Points (24 Pcs, mm)



3/8"



| CODE | Sockets | Accessories | g | |
|--------------|---|------------------------|------|----|
| 14000 005134 | 7 - 8 - 9 10 - 11 - 12 13 - 14 - 15 16 - 17 - 19 | Ratchet Handle | 2010 | 24 |
| | Six Points | Universal Joint | | |
| | 8 - 10 - 11 12 - 13 - 14 16 - 17 - 19 | Extension Bar 75 mm | | |
| | Six Points Deep | | | |

14000 005135

Socket Wrench Set 6 Points
and Hexagonal Bit Socket
Wrench Set (35 Pcs, mm)



3/8"



| CODE | Sockets | Accessories | g | |
|--------------|---|--|------|----|
| 14000 005135 | 6 - 7 - 8 - 9 10 - 11 - 13 14 - 17 - 19 | Ratchet Handle | 2240 | 35 |
| | Six Points | Universal Joint | | |
| | E4 - E5 - E6 E7 - E8 - E10 E12 - E14 - E16 E18 | Extension Bar 75 mm - 150 mm | | |
| | Sliding T Handle | | | |
| | Star (Torx) | H3 - H4 - H5 - H6 - H8 Hexagonal Bit Socket | | |
| | Torx Socket Wrench | T20 - T25 - T27 T30 - T40 | | |

1113 00 6145

Display Frame for Sockets (145 Pcs)



1/2"

| CODE | CONTENTS | g | □ |
|--------------|--|--------|---|
| 1113 00 6145 | Full 10-11-12-13-14-15-16-17-18-19 10 Pcs 21-22-23-24-26-27-28-30-32 5 Pcs | 18.236 | 1 |

1113

Socket Wrench 6 Points (mm)



1/2"

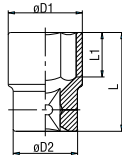

TS ISO 2725 -1
DIN 3124

Chrom plated

| CODE | mm | ø D1 mm | ø D2 mm | L mm | L1 mm | g | □ |
|--------------|----|---------|---------|------|-------|-----|----|
| 1113 06 1008 | 8 | 14 | 22 | 38 | 7 | 55 | 10 |
| 1113 06 1009 | 9 | 14.1 | 22 | 38 | 7 | 55 | 10 |
| 1113 06 1010 | 10 | 15.4 | 22 | 38 | 8 | 55 | 10 |
| 1113 06 1011 | 11 | 16.6 | 22 | 38 | 8 | 60 | 10 |
| 1113 06 1012 | 12 | 17.8 | 22 | 38 | 9 | 60 | 10 |
| 1113 06 1013 | 13 | 19 | 22 | 38 | 10 | 65 | 10 |
| 1113 06 1014 | 14 | 20.4 | 22 | 38 | 11 | 65 | 10 |
| 1113 06 1015 | 15 | 21.6 | 22 | 38 | 11 | 65 | 10 |
| 1113 06 1016 | 16 | 22.9 | 22 | 38 | 11 | 70 | 10 |
| 1113 06 1017 | 17 | 24 | 22 | 38 | 12 | 70 | 10 |
| 1113 06 1018 | 18 | 25.4 | 23 | 38 | 13 | 75 | 10 |
| 1113 06 1019 | 19 | 26.6 | 23 | 38 | 13 | 75 | 10 |
| 1113 06 1020 | 20 | 28 | 24 | 38 | 13 | 80 | 10 |
| 1113 06 1021 | 21 | 29.2 | 24 | 38 | 13 | 85 | 5 |
| 1113 06 1022 | 22 | 30.4 | 26 | 38 | 15 | 95 | 5 |
| 1113 06 1023 | 23 | 31.2 | 28 | 38 | 15 | 100 | 5 |
| 1113 06 1024 | 24 | 32.9 | 28 | 38 | 17 | 115 | 5 |
| 1113 06 1025 | 25 | 33.2 | 29 | 42 | 17 | 125 | 5 |
| 1113 06 1026 | 26 | 34 | 30 | 42 | 17 | 135 | 5 |
| 1113 06 1027 | 27 | 36.6 | 30 | 42 | 19 | 140 | 5 |
| 1113 06 1028 | 28 | 37.5 | 30 | 42 | 20 | 160 | 5 |
| 1113 06 1029 | 29 | 39.5 | 32 | 42 | 21 | 170 | 5 |
| 1113 06 1030 | 30 | 40 | 32 | 44 | 21 | 180 | 5 |
| 1113 06 1032 | 32 | 43 | 34 | 44 | 23 | 190 | 5 |

Socket Wrench 6 Points 1000V (mm)

TS ISO 2725 -1
DIN 3124
△ 1000 V
IEC 60900



1/2"

Chrom plated

| CODE | mm | ø D1 mm | ø D2 mm | L mm | L1 mm | g | □ |
|--------------|----|---------|---------|------|-------|----|---|
| 13000 005148 | 10 | 19.5 | 27 | 40 | 7 | 55 | 1 |
| 13000 005149 | 11 | 20.7 | 27 | 40 | 7 | 55 | 1 |
| 13000 005150 | 12 | 22 | 27 | 40 | 8 | 55 | 1 |
| 13000 005151 | 13 | 23.2 | 27 | 40 | 8 | 60 | 1 |
| 13000 005152 | 14 | 24.5 | 27 | 40 | 9 | 60 | 1 |
| 13000 005153 | 15 | 25.7 | 27 | 40 | 10 | 65 | 1 |
| 13000 005154 | 16 | 27 | 27 | 40 | 11 | 65 | 1 |
| 13000 005155 | 17 | 28.2 | 27 | 40 | 11 | 65 | 1 |
| 13000 005156 | 19 | 30.7 | 27 | 42 | 11 | 70 | 1 |
| 13000 005157 | 22 | 34.5 | 27 | 44 | 12 | 70 | 1 |
| 13000 005158 | 24 | 37 | 27 | 46 | 13 | 75 | 1 |
| 13000 005159 | 27 | 40.7 | 27 | 48 | 13 | 75 | 1 |

1113

Spark Plug Socket with Rubber



1/2"

Chrom plated

| CODE | mm | L mm | g | □ |
|--------------|----|------|-----|----|
| 1113 06 9160 | 16 | 70 | 80 | 10 |
| 1113 06 9208 | 21 | 70 | 155 | 10 |

1114

Socket Wrench 12 Points (mm)

TS ISO 2725 - 1
DIN 3124

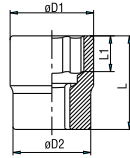

Chrom plated

1/2"

| CODE | Ø mm | ø D1 mm | ø D2 mm | L mm | L1 mm | g | □ |
|--------------|------|---------|---------|------|-------|-----|----|
| 1114 06 1010 | 10 | 15 | 23.3 | 38 | 8 | 60 | 10 |
| 1114 06 1011 | 11 | 16.4 | 23.3 | 38 | 8 | 60 | 10 |
| 1114 06 1012 | 12 | 17.8 | 23.3 | 38 | 9 | 60 | 10 |
| 1114 06 1013 | 13 | 19 | 23.3 | 38 | 10 | 60 | 10 |
| 1114 06 1014 | 14 | 20.4 | 23.3 | 38 | 11 | 60 | 10 |
| 1114 06 1015 | 15 | 21.6 | 23.3 | 38 | 11 | 65 | 10 |
| 1114 06 1016 | 16 | 22.9 | 24 | 38 | 11 | 70 | 10 |
| 1114 06 1017 | 17 | 24 | 22.5 | 38 | 12 | 70 | 10 |
| 1114 06 1018 | 18 | 25.2 | 23 | 38 | 13 | 70 | 10 |
| 1114 06 1019 | 19 | 26.8 | 23 | 38 | 13 | 75 | 10 |
| 1114 06 1020 | 20 | 28 | 23 | 38 | 13 | 80 | 10 |
| 1114 06 1021 | 21 | 29.2 | 23 | 38 | 13 | 80 | 5 |
| 1114 06 1022 | 22 | 30.2 | 24 | 40 | 15 | 95 | 5 |
| 1114 06 1023 | 23 | 31.4 | 25 | 40 | 15 | 100 | 5 |
| 1114 06 1024 | 24 | 32.6 | 26 | 42 | 17 | 105 | 5 |
| 1114 06 1026 | 26 | 35.3 | 28 | 42 | 17 | 135 | 5 |
| 1114 06 1027 | 27 | 36.6 | 28 | 42 | 19 | 135 | 5 |
| 1114 06 1028 | 28 | 37.8 | 30 | 42 | 20 | 155 | 5 |
| 1114 06 1030 | 30 | 40 | 30 | 44 | 21 | 165 | 5 |
| 1114 06 1032 | 32 | 42.5 | 30 | 44 | 23 | 180 | 5 |

1413

Socket Wrench 12 Points (SAE)

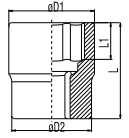

Chrom plated

1/2"

| CODE | Ø inch | ø D1 mm | ø D2 mm | L mm | L1 mm | g | □ |
|--------------|---------|---------|---------|------|-------|-----|----|
| 1413 06 1008 | 5/16" | 13.2 | 21.8 | 37 | 6 | 45 | 10 |
| 1413 06 1095 | 3/8" | 15 | 21.8 | 37 | 8 | 50 | 10 |
| 1413 06 1010 | 7/16" | 16.4 | 23.3 | 37 | 9 | 60 | 10 |
| 1413 06 1011 | 15/32" | 18 | 23.3 | 37 | 9 | 60 | 10 |
| 1413 06 1012 | 1/2" | 19 | 23.3 | 37 | 9 | 60 | 10 |
| 1413 06 1013 | 9/16" | 20.4 | 23.3 | 37 | 11 | 60 | 10 |
| 1413 06 1014 | 19/32" | 21.6 | 23.3 | 37 | 11 | 65 | 10 |
| 1413 06 1015 | 5/8" | 23.1 | 22 | 38 | 11 | 70 | 10 |
| 1413 06 1016 | 11/16" | 24.5 | 22.5 | 38 | 11 | 70 | 10 |
| 1413 06 1017 | 3/4" | 26.8 | 23 | 38 | 13 | 75 | 10 |
| 1413 06 1020 | 25/32" | 28 | 23 | 38 | 13 | 75 | 10 |
| 1413 06 1021 | 13/16" | 28.6 | 23 | 38 | 13 | 80 | 10 |
| 1413 06 1022 | 7/8" | 30.2 | 24 | 40 | 15 | 90 | 5 |
| 1413 06 1024 | 15/16" | 32.6 | 26 | 42 | 17 | 115 | 5 |
| 1413 06 1025 | 1" | 35 | 28 | 42 | 17 | 130 | 5 |
| 1413 06 1027 | 1 1/16" | 36.6 | 28 | 42 | 19 | 135 | 5 |
| 1413 06 1029 | 1 1/8" | 38.8 | 30 | 42 | 19 | 170 | 5 |
| 1413 06 1030 | 1 3/16" | 40 | 29.5 | 44 | 20 | 170 | 5 |
| 1413 06 1032 | 1 1/4" | 42.5 | 30 | 44 | 22 | 185 | 5 |

14000 005130

Twist Socket Wrench Set (10 Pcs,mm)

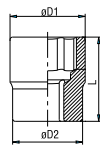

Phosphate finish

1/2"

| CODE | mm | ø D1 mm | ø D2 mm | L mm | Ad. Boy | g | □ |
|--------------|----|---------|---------|------|---------|-----|---|
| | 10 | 16 | 22 | 34 | - | | 1 |
| | 11 | 17.5 | 22 | 34 | - | | 1 |
| | 12 | 18.5 | 22 | 34 | - | | 1 |
| | 13 | 20.4 | 22 | 34 | - | | 1 |
| | 14 | 21.5 | 25 | 34 | - | | 1 |
| 14000 005130 | 15 | 22.5 | 25 | 34 | - | 790 | 1 |
| | 16 | 23.5 | 25 | 34 | - | | 1 |
| | 17 | 25.8 | 25 | 34 | - | | 1 |
| | 19 | 28.7 | 27 | 34 | - | | 1 |



Do not use with power-tools

Deep Socket Wrench 6 Points (mm)

TS ISO 2725 -
DIN 312



Chrom plated

| CODE | mm | øD1 mm | øD2 mm | L mm | L1 mm | g | |
|--------------|----|--------|--------|------|-------|-----|----|
| 1108 06 0010 | 10 | 15,2 | 22 | 75 | 6 | 110 | 10 |
| 1108 06 0011 | 11 | 16,7 | 24 | 75 | 7 | 110 | 10 |
| 1108 06 0012 | 12 | 18 | 24 | 75 | 8 | 110 | 10 |
| 1108 06 0013 | 13 | 19 | 24 | 75 | 8 | 120 | 10 |
| 1108 06 0014 | 14 | 20,5 | 24 | 75 | 10 | 120 | 10 |
| 1108 06 0015 | 15 | 21,7 | 24 | 75 | 10 | 140 | 10 |
| 1108 06 0016 | 16 | 22 | 25,5 | 75 | 10 | 140 | 10 |
| 1108 06 0017 | 17 | 24 | 25,5 | 75 | 10 | 140 | 10 |
| 1108 06 0018 | 18 | 25,5 | 25,5 | 75 | 12 | 150 | 10 |
| 1108 06 0019 | 19 | 26 | 26,7 | 75 | 12 | 150 | 10 |

Socket Wrench



Chrom plated

| CODE | | øD1 mm | øD2 mm | L mm | L1 mm | g | |
|--------------|-----|--------|--------|------|-------|----|----|
| 1113 06 0210 | E10 | 13.2 | 23.8 | 37 | 7.5 | 60 | 10 |
| 1113 06 0212 | E12 | 15 | 23.8 | 37 | 9 | 65 | 10 |
| 1113 06 0214 | E14 | 16.4 | 23.8 | 37 | 10 | 65 | 10 |
| 1113 06 0216 | E16 | 18.8 | 23.8 | 37 | 11 | 70 | 10 |
| 1113 06 0218 | E18 | 20.5 | 23.8 | 39 | 12.5 | 75 | 10 |
| 1113 06 0220 | E20 | 23 | 23.8 | 39 | 14 | 75 | 10 |

1108 00 6010

Deep Socket Set (10 pcs. mm)



| CODE | CONTENTS | g | |
|--------------|----------------------------------|------|----|
| 1108 00 6010 | 10-11-12-13-14-15 16-17-18-19 | 1290 | 10 |

1113 00 6007

Star Torx® Socket Wrench Set (7 Pcs)



| CODE | CONTENTS | g | |
|--------------|--|------|---|
| 1113 00 6007 | E10 - E12 - E14 - E16 - E18 - E20 Extension Bar | 1075 | 7 |

Do not use with power-tools

1113

Hexagonal Bit Socket Wrench



1/2"

Chrom plated

| CODE | mm | L mm | g | |
|--------------|----|------|-----|----|
| 1113 06 1105 | 5 | 60 | 70 | 10 |
| 1113 06 1106 | 6 | 60 | 70 | 10 |
| 1113 06 1107 | 7 | 60 | 75 | 10 |
| 1113 06 1108 | 8 | 60 | 75 | 10 |
| 1113 06 1110 | 10 | 60 | 85 | 10 |
| 1113 06 1112 | 12 | 60 | 100 | 10 |
| 1113 06 1114 | 14 | 60 | 115 | 10 |
| 1113 06 4105 | 5 | 100 | 90 | 10 |
| 1113 06 4106 | 6 | 100 | 90 | 10 |
| 1113 06 4107 | 7 | 100 | 90 | 10 |
| 1113 06 4108 | 8 | 100 | 95 | 10 |
| 1113 06 4110 | 10 | 100 | 105 | 10 |
| 1113 06 4112 | 12 | 100 | 145 | 10 |
| 1113 06 4114 | 14 | 100 | 155 | 10 |
| 1113 06 4117 | 17 | 100 | 200 | 10 |

1113

Star (Torx) Bit Socket Wrench



1/2"

Chrom plated

| CODE | | L mm | g | |
|--------------|-----|------|-----|----|
| 1113 06 1220 | T20 | 60 | 70 | 10 |
| 1113 06 1225 | T25 | 60 | 70 | 10 |
| 1113 06 1227 | T27 | 60 | 70 | 10 |
| 1113 06 1230 | T30 | 60 | 70 | 10 |
| 1113 06 1240 | T40 | 60 | 70 | 10 |
| 1113 06 1245 | T45 | 60 | 70 | 10 |
| 1113 06 1250 | T50 | 60 | 75 | 10 |
| 1113 06 1255 | T55 | 60 | 80 | 10 |
| 1113 06 1260 | T60 | 60 | 100 | 10 |
| 1113 06 4220 | T20 | 100 | 78 | 10 |
| 1113 06 4225 | T25 | 100 | 79 | 10 |
| 1113 06 4227 | T27 | 100 | 80 | 10 |
| 1113 06 4230 | T30 | 100 | 80 | 10 |
| 1113 06 4240 | T40 | 100 | 80 | 10 |
| 1113 06 4245 | T45 | 100 | 82 | 10 |
| 1113 06 4250 | T50 | 100 | 82 | 10 |
| 1113 06 4255 | T55 | 100 | 100 | 10 |
| 1113 06 4260 | T60 | 100 | 134 | 10 |

1113 00 1107

Hexagonal Bits Socket Wrench Set (60 mm, 7 Pcs)



1/2"

| CODE | CONTENTS | g | |
|------|----------|---|--|
|------|----------|---|--|

1113 00 1107 Hex Bit Socket 5-6-7-8-10-12-14 1040 7

1113 00 6009

Torx® Bits Socket Wrench Set (60 mm, 9 Pcs)



1/2"

| CODE | CONTENTS | g | |
|------|----------|---|--|
|------|----------|---|--|

1113 00 6009 Star Socket T20 - T25 - T27 - T30 - T40 - T45 T50 - T55 - T60 1125 9

1113 00 6017

Hex Bit Sockets - Torx Bit Sockets Set (17 Pcs)



1/2"

| CODE | CONTENTS | g | |
|------|---|---|----|
| 1113 | Sliding T Handle | | |
| 1113 | 5 - 6 - 7 - 8 - 10 - 12 - 14 Lokmalı Allen Uç 60mm Hex Bit Socket | | |
| 1113 | T20 - T25 - T27 T30 - T40 T45 - T50 - T55 - T60 Lokmalı Star (Torx) Uç 60mm Torx Bit Socket | | 17 |

1114

Hex Bit Socket 12 Points (XZN)



1/2"

Chrom plated

| CODE | | L mm | g | |
|--------------|-----|------|-----|----|
| 1114 06 4005 | M5 | 60 | 60 | 10 |
| 1114 06 4006 | M6 | 60 | 62 | 10 |
| 1114 06 4008 | M8 | 60 | 62 | 10 |
| 1114 06 4010 | M10 | 60 | 78 | 10 |
| 1114 06 4012 | M12 | 60 | 84 | 10 |
| 1114 06 4106 | M6 | 80 | 69 | 10 |
| 1114 06 4108 | M8 | 80 | 70 | 10 |
| 1114 06 4110 | M10 | 80 | 84 | 10 |
| 1114 06 4112 | M12 | 80 | 103 | 10 |
| 1114 06 4114 | M14 | 80 | 133 | 10 |
| 1114 06 4208 | M8 | 140 | 96 | 10 |
| 1114 06 4210 | M10 | 140 | 125 | 10 |
| 1114 06 4212 | M12 | 140 | 161 | 10 |
| 1114 06 4214 | M14 | 140 | 210 | 10 |
| 1114 06 4216 | M16 | 140 | 281 | 10 |

Do not use with power-tools

1114

Socket Wrench 6 Points



1/2"

Chrom plated

| CODE | | L mm | g | |
|--------------|------|------|-----|----|
| 1114 06 5004 | 4 | 100 | 75 | 10 |
| 1114 06 5005 | 5 | 100 | 76 | 10 |
| 1114 06 5006 | 6 | 100 | 76 | 10 |
| 1114 06 5007 | 7 | 100 | 77 | 10 |
| 1114 06 5008 | 8 | 100 | 78 | 10 |
| 1114 06 5009 | 9 | 100 | 85 | 10 |
| 1114 06 5010 | 10 | 100 | 96 | 10 |
| 1114 06 5011 | 10.5 | 100 | 96 | 10 |
| 1114 06 5012 | 12 | 100 | 121 | 10 |
| 1114 06 5013 | 13 | 100 | 148 | 10 |
| 1114 06 5014 | 14 | 100 | 150 | 10 |
| 1114 06 5016 | 16 | 100 | 198 | 10 |

1513 06 0032

Ratchet Handle (32 Teeth)



TS ISO 3315
DIN3122



1/2"

Chrom plated

| CODE | L mm | g | |
|--------------|------|-----|---|
| 1513 06 0032 | 250 | 580 | 5 |

13000 005277

Ratchet Handle 1000V (36 Teeth)

1000 V
IEC 60900



1/2"

| CODE | L mm | g | |
|--------------|------|-----|---|
| 13000 005277 | 275 | 540 | 1 |

1513

Extension Bar



TS ISO 3316
TS ISO 1174-1
DIN 3123

1/2"

Chrom vanadium, Chrom plated

| CODE | L mm | g | □ |
|--------------|------|-----|---|
| 1513 06 4075 | 75 | 140 | 5 |
| 1513 06 4125 | 125 | 215 | 5 |
| 1513 06 4250 | 250 | 420 | 5 |

13000 005541

1000V Sliding T - Handle



⚡ 1000 V
IEC 60900



1/2"

Chrom vanadium, Chrom plated

| CODE | L mm | g | □ |
|--------------|------|-----|---|
| 13000 005541 | 250 | 355 | 5 |

Extension Bar 1000V

⚡ 1000 V
IEC 60900



1/2"

Chrom plated

| CODE | L mm | g | □ |
|--------------|------|-----|---|
| 13000 005262 | 75 | 140 | 1 |
| 13000 005263 | 125 | 215 | 1 |
| 13000 005264 | 250 | 420 | 1 |

1513 06 4070

Universal Joint

TS ISO 3316
DIN 3123



1/2"

Chrom plated

| CODE | L mm | g | □ |
|--------------|------|-----|---|
| 1513 06 4070 | 70 | 140 | 5 |

1513 06 5250

Adapter



1/2"

Chrom plated

| CODE | inch | g | □ |
|--------------|-------------|----|---|
| 1513 06 5250 | 3/8"Fx1/2"M | 90 | 5 |

1513

Adapter

TS ISO 3316
DIN 3123



1/2"

Chrom plated

| CODE | inch | g |
|--------------|-------------|-----|
| 1513 06 0002 | 1/2"Fx3/8"M | 55 |
| 1513 06 0003 | 1/2"Fx3/4"M | 115 |

1513 06 2250

Sliding T Handle

TS ISO 3315
DIN 3122



1/2"

, Chrom plated

| CODE | L mm | g | □ |
|--------------|------|-----|---|
| 1513 06 2250 | 250 | 355 | 5 |

1113 06 5010

Bit Holder Scocket



1/2"

Chrom plated

| CODE | inch | g | □ |
|--------------|-----------------|-----|---|
| 1113 06 5010 | 1/2" F x 1/4" F | 355 | 5 |

Socket Wrench Set 6 Point 1/4" - 1/2" (35 Pcs)



1/4"

1/2"

| CODE | Sockets | Accessories | g | |
|--------------|--|--------------------------|------|----|
| 1113 00 1038 | | Ratchet Handle | | |
| | 4 - 5 - 6 7 - 8 - 9 - 10 11 - 12 - 13 Altı Köşe Six Points | Universal Joint | | |
| | | Sliding T Handle | | |
| | | Extension Bar 50 mm | | |
| | | Extension Bar 100 mm | 4000 | 35 |
| | | Ratchet Handle | | |
| | | Sliding T Handle Adapter | | |
| | | Extension Bar 75 mm | | |
| | | Extension Bar 250 mm | | |
| | | Six Points | | |

Do not use with power-tools

1113 00 2017
Socket Wrench Set 6 Points (17 pcs, mm)

| CODE | Sockets | Accessories | g | |
|--------------|--------------|--------------------------|------|----|
| 1113 00 2017 | | Ratchet Handle | 2880 | 17 |
| | 10 - 11 - 12 | Sliding T Handle Adapter | | |
| | 13 - 14 - 15 | | | |
| | 17 - 19 - 22 | | | |
| | 24 - 27 - 30 | | | |
| | 32 | Universal Joint | | |
| | | Extension Bar 250 mm | | |

1113 00 2024
Socket Wrench Set 6 Points (24 pcs, mm)

| CODE | Sockets | Accessories | g | |
|--------------|--------------|--------------------------|------|----|
| 1113 00 2024 | | Ratchet Handle | 3650 | 24 |
| | 10 - 11 - 12 | Universal Joint | | |
| | 13 - 14 - 15 | Sliding T Handle Adapter | | |
| | 16 - 17 - 18 | | | |
| | 19 - 21 - 22 | | | |
| | 23 - 24 - 26 | Extension Bar 125 mm | | |
| | 27 - 28 - 30 | Extension Bar 250 mm | | |
| 32 | | | | |

1114 00 6024
Socket Wrench Set 12 Points (24 pcs, mm)

| CODE | Sockets | Accessories | g | |
|--------------|----------------------|--------------------------|------|----|
| 1114 00 6024 | | Ratchet Handle | 4150 | 24 |
| | | Universal Joint | | |
| | 10 - 11 - 12 | Sliding T Handle Adapter | | |
| | 13 - 14 - 15 | | | |
| | 16 - 17 - 18 | | | |
| | 19 - 21 - 22 | | | |
| 23 - 24 - 26 | Extension Bar 125 mm | | | |
| 27 - 28 - 30 | Extension Bar 250 mm | | | |
| 32 | | | | |

1413 00 6024
Socket Wrench Set 12 Points (24 pcs, SAE)

| CODE | Sockets | Accessories | g | |
|--------------|-----------------------------|--------------------------|------|----|
| 1413 00 6024 | | Ratchet Handle | 4150 | 24 |
| | 5/16" - 3/8" 7/16" - 15/32" | Universal Joint | | |
| | 1/2" - 9/16" | Sliding T Handle Adapter | | |
| | 19/32" - 5/8" | | | |
| | 11/16" - 3/4" | | | |
| | 25/32" - 13/16" | Extension Bar 125 mm | | |
| | 7/8" - 15/16" | | | |
| | 1" - 1 1/16" | | | |
| | 1 1/8" - 1 3/16" | | | |
| | 1 1/4" | Extension Bar 250 mm | | |

New Socket Wrench Sets



Product Code
14000 005131



Product Code
14000 005133



Product Code
14000 005130



Product Code
14000 005132



Product Code
14000 005134



Product Code
14000 005135

1119

Socket Wrench 6 Points (mm)

TS ISO 2725 -1
DIN 3124



3/4"

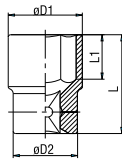

, Chrom plated

| CODE | mm | $\sigma D1$ mm | $\sigma D2$ mm | L mm | L1 mm | g | □ |
|--------------|----|----------------|----------------|------|-------|------|---|
| 1119 06 1022 | 22 | 33 | 36 | 52 | 16 | 225 | 5 |
| 1119 06 1024 | 24 | 35 | 36 | 52 | 16 | 230 | 5 |
| 1119 06 1027 | 27 | 38 | 36 | 52 | 19 | 235 | 5 |
| 1119 06 1030 | 30 | 42 | 38 | 54 | 21 | 300 | 5 |
| 1119 06 1032 | 32 | 44 | 38 | 56 | 23 | 320 | 5 |
| 1119 06 1034 | 34 | 47 | 42 | 58 | 24 | 400 | 5 |
| 1119 06 1036 | 36 | 50 | 42 | 58 | 25 | 440 | 5 |
| 1119 06 1038 | 38 | 52 | 45 | 60 | 27 | 500 | 5 |
| 1119 06 1041 | 41 | 56 | 45 | 64 | 29 | 580 | 1 |
| 1119 06 1046 | 46 | 62 | 48 | 68 | 33 | 730 | 1 |
| 1119 06 1050 | 50 | 68 | 48 | 72 | 34 | 885 | 1 |
| 1119 06 1055 | 55 | 74 | 48 | 76 | 37 | 1070 | 1 |
| 1119 06 1060 | 60 | 80 | 48 | 78 | 38 | 1170 | 1 |

1120

Socket Wrench 12 Points (mm)

TS ISO 2725 - 1
DIN 3124



3/4"

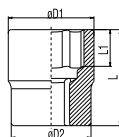

Chrom plated

| CODE | mm | $\sigma D1$ mm | $\sigma D2$ mm | L mm | L1 mm | g | □ |
|--------------|----|----------------|----------------|------|-------|-----|---|
| 1120 06 1022 | 22 | 33 | 36 | 52 | 16 | 220 | 5 |
| 1120 06 1024 | 24 | 35 | 36 | 52 | 17 | 225 | 5 |
| 1120 06 1027 | 27 | 38 | 36 | 52 | 19 | 225 | 5 |
| 1120 06 1030 | 30 | 42 | 38 | 54 | 21 | 285 | 5 |
| 1120 06 1032 | 32 | 44 | 38 | 56 | 23 | 310 | 5 |
| 1120 06 1034 | 34 | 47 | 42 | 57 | 24 | 385 | 5 |
| 1120 06 1036 | 36 | 50 | 42 | 58 | 25 | 435 | 5 |
| 1120 06 1041 | 41 | 56 | 45 | 64 | 29 | 560 | 1 |
| 1120 06 1046 | 46 | 62 | 47 | 68 | 34 | 685 | 1 |
| 1120 06 1050 | 50 | 68 | 48 | 72 | 34 | 840 | 1 |

1419

Socket Wrench 12 Points (SAE)



3/4"

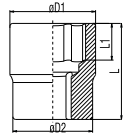

Chrom plated

| CODE | inch | $\sigma D1$ mm | $\sigma D2$ mm | L mm | L1 mm | g | □ |
|--------------|----------|----------------|----------------|------|-------|-----|---|
| 1419 06 1022 | 7/8" | 33 | 36 | 52 | 16 | 220 | 5 |
| 1419 06 1024 | 15/16" | 35 | 36 | 52 | 16 | 220 | 5 |
| 1419 06 1025 | 1" | 35 | 36 | 52 | 17 | 220 | 5 |
| 1419 06 1027 | 1 1/16" | 38 | 36 | 52 | 19 | 225 | 5 |
| 1419 06 1028 | 1 1/8" | 40 | 38 | 52 | 19 | 225 | 5 |
| 1419 06 1032 | 1 1/4" | 44 | 38 | 56 | 23 | 315 | 5 |
| 1419 06 1033 | 1 5/16" | 46 | 38 | 56 | 23 | 355 | 5 |
| 1419 06 1035 | 1 3/8" | 48 | 42 | 58 | 25 | 400 | 5 |
| 1419 06 1036 | 1 7/16" | 50 | 42 | 58 | 25 | 425 | 5 |
| 1419 06 1038 | 1 1/2" | 52 | 45 | 60 | 27 | 475 | 5 |
| 1419 06 1041 | 1 5/8" | 56 | 45 | 64 | 29 | 555 | 1 |
| 1419 06 1044 | 1 3/4" | 60 | 47 | 66 | 31 | 660 | 1 |
| 1419 06 1046 | 1 13/16" | 62 | 47 | 68 | 34 | 685 | 1 |
| 1419 06 1047 | 1 7/8" | 64 | 48 | 70 | 34 | 730 | 1 |
| 1419 06 1050 | 2" | 68 | 48 | 72 | 34 | 805 | 1 |

1519 06 4510

Ratchet Handle (45 Teeth)

TS ISO 3315
DIN 3122

3/4"



Chrom plated

| CODE | L mm | g | □ |
|--------------|------|------|---|
| 1519 06 4510 | 510 | 2230 | 5 |

1519

Extension Bar

TS ISO 3316
DIN 3123

3/4"



Chrom plated

| CODE | L mm | g | □ |
|--------------|------|------|---|
| 1519 06 4200 | 200 | 730 | 5 |
| 1519 06 4400 | 400 | 1370 | 5 |

1519 06 4500

Sliding T - Handle

TS ISO 3315
DIN 3122



3/4"

Chrom vanadium, Chrom plated

| CODE | L mm | g | |
|--------------|------|------|---|
| 1519 06 4500 | 500 | 1485 | 5 |

1519

Adapter

TS ISO 3316
DIN 3123



3/4"

Chrom vanadium, Chrom plated

| CODE | inch | g | |
|--------------|-------------|-----|---|
| 1519 06 0008 | 3/4"Fx1/2"M | 140 | 5 |
| 1519 06 0001 | 3/4"Fx1"M | 300 | 5 |

1119 00 6114

Socket Wrench Set 6 Points (14 pcs, mm)



3/4"

| CODE | Sockets | Accessories | g | |
|--------------|---|----------------------|-------|----|
| 1119 00 6114 | | Ratchet Handle | 10180 | 14 |
| | | Sliding T Handle | | |
| | 22 - 24 - 27 30 - 32 - 34 36 - 41 - 46 50 | Extension Bar 200 mm | | |
| | | Extension Bar 400 mm | | |

1120 00 6014

Socket Wrench Set 12 Points (14 pcs, mm)



3/4"

| CODE | Sockets | Accessories | g | |
|--------------|--|----------------------|-------|----|
| 1120 00 6014 | | Ratchet Handle | 13700 | 14 |
| | 22 - 24 - 27 30 - 32 - 34 36 - 41 - 46 50 | Sliding T Handle | | |
| | | Extension Bar 200 mm | | |
| | | Extension Bar 400 mm | | |

1419 00 6114

Socket Wrench Set 12 Points (14 pcs, SAE)



3/4"

| CODE | Sockets | Accessories | g | |
|--------------|---|----------------------|-------|----|
| 1419 00 6114 | | Ratchet Handle | 10180 | 14 |
| | 15/16" - 11/16" 11/8" - 11/4" 15/16" 13/8" | Sliding T Handle | | |
| | 11/2" - 15/8" 17/8" - 2" | Extension Bar 200 mm | | |
| | | Extension Bar 400 mm | | |

Do not use with power-tools

1225

Socket Wrench 12 Points (mm)

TS ISO 2727-1
DIN 3124

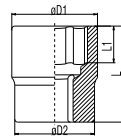

Chrom plated

| CODE | mm | ø D1 mm | ø D2 mm | L mm | L1 mm | g | |
|--------------|----|---------|---------|------|-------|------|---|
| 1225 06 0036 | 36 | 52 | 48 | 65 | 26 | 525 | 1 |
| 1225 06 0041 | 41 | 58 | 50 | 70 | 29 | 665 | 1 |
| 1225 06 0046 | 46 | 65 | 54 | 75 | 32 | 900 | 1 |
| 1225 06 0050 | 50 | 70 | 57 | 75 | 34 | 1040 | 1 |
| 1225 06 0055 | 55 | 76 | 57 | 83 | 42 | 1250 | 1 |
| 1225 06 0060 | 60 | 82 | 60 | 87 | 46 | 1505 | 1 |

1525 06 0005

Adapter

TS ISO 3316
DIN 3123



Chrom plated

| CODE | inch | g | |
|--------------|-----------|-----|---|
| 1525 06 0005 | 1"Fx3/4"M | 330 | 5 |

Do not use with power-tools

1800

Double Ended Tubular Socket Wrench (mm)

TS ISO 3793
DIN 896

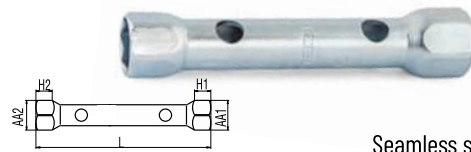

Seamless steel tube, Zinc plated

| CODE | mm | L mm | AA1 mm | AA2 mm | H1 mm | H2 mm | g | |
|--------------|-------|------|--------|--------|-------|-------|-----|---|
| 1800 07 0607 | 6x7 | 105 | 8.6 | 9.6 | 7 | 8 | 25 | 5 |
| 1800 07 0809 | 8x9 | 105 | 11.2 | 12.2 | 9 | 10 | 35 | 5 |
| 1800 07 1011 | 10x11 | 120 | 13.6 | 14.6 | 11 | 11.5 | 55 | 5 |
| 1800 07 1213 | 12x13 | 135 | 16 | 17 | 12 | 12.5 | 80 | 5 |
| 1800 07 1415 | 14x15 | 135 | 18.5 | 19.5 | 13 | 13.5 | 110 | 5 |
| 1800 07 1617 | 16x17 | 150 | 21 | 22 | 14 | 14.5 | 150 | 5 |
| 1800 07 1819 | 18x19 | 150 | 23 | 24 | 15 | 15.5 | 170 | 5 |
| 1800 07 2022 | 20x22 | 165 | 25.4 | 27.4 | 16 | 18 | 220 | 5 |
| 1800 07 2224 | 22x24 | 180 | 27.4 | 29.4 | 18 | 20 | 330 | 5 |
| 1800 07 2427 | 24x27 | 180 | 30.4 | 33.4 | 20 | 23 | 400 | 5 |

1800 00 2108

Double Ended Tubular Socket Wrench Set with Tommy Bars (mm)



| CODE | mm | g | |
|--------------|--|-----|----|
| 1800 00 2108 | 6x7 - 8x9 - 10x11 - 12x13 - 14x15 16x17 - 18x19 - 20x22 Handle Bars 5x125-8x180 mm | 920 | 10 |

1841 07 0021

Single Ended Tubular Socket Wrench with Tommy Bar



Seamless steel tube, Zinc plated

| CODE | mm | | L mm | øD mm | Handle bar mm | g | |
|--------------|----|--------|------|-------|---------------|-----|---|
| | mm | inch | | | | | |
| 1841 07 0021 | 21 | 13/16" | 120 | 20 | 10x120 | 215 | 5 |

1850

Tommy Bar

TS ISO 3793
DIN 900



| CODE | σDxL mm | g | □ |
|--------------|------------|-----|----|
| 1850 07 5125 | 5x125 | 20 | 10 |
| 1850 07 8180 | 8x180 | 70 | 10 |
| 1850 07 1120 | 10x120 | 75 | 10 |
| 1850 07 1200 | 10x200 | 120 | 10 |

1870

Double Ended Rim Wrench (long)

TSEK

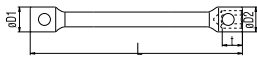

Special steel, Nickel plated

| CODE | mm | L mm | t mm | σD1 mm | σD2 mm | g | □ |
|--------------|-------|---------|---------|-----------|-----------|------|----|
| 1870 09 2427 | 24x27 | 400 | 34.5 | 36 | 40 | 1135 | 10 |
| 1870 09 2730 | 27x30 | 400 | 34.5 | 40 | 44 | 1380 | 10 |
| 1870 09 2732 | 27x32 | 400 | 34.5 | 40 | 46 | 1380 | 10 |
| 1870 09 3032 | 30x32 | 400 | 34.5 | 44 | 46 | 1380 | 10 |
| 1870 09 3233 | 32x33 | 400 | 34.5 | 46 | 47 | 1450 | 10 |

1874

Double Ended Rim Wrench (short)

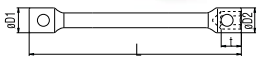

Special steel, Nickel plated

| CODE | mm | L mm | t mm | σD1 mm | σD2 mm | g | □ |
|--------------|-------|---------|---------|-----------|-----------|-----|----|
| 1874 09 2224 | 22x24 | 170 | 34.5 | 34 | 36 | 720 | 10 |
| 1874 09 2427 | 24x27 | 200 | 34.5 | 36 | 40 | 800 | 10 |

1850 09 1630

Tommy Bar

TS ISO 3793
DIN 900

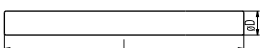

| CODE | σDxL mm | g | □ |
|--------------|------------|------|---|
| 1850 09 1630 | 18x630 | 1260 | 1 |

1975 09 1719

Cross Rim Wrench

TSE

TS ISO 6788

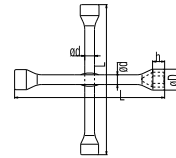

Special steel, Chrom plated

| CODE | mm | inch | σD mm | h mm | L mm | σd mm | g | □ |
|--------------|----|--------|----------|---------|---------|----------|------|----|
| | 17 | 11/16" | 28 | 17 | | | | |
| 1975 09 1719 | 19 | 3/4" | 30 | 18.5 | 420 | 16 | 1422 | 10 |
| | 21 | 13/16" | 32 | 19.5 | | | | |
| | 22 | 7/8" | 34 | 20.5 | | | | |

1975 09 1322

Cross Rim Wrench (with 1/2" adapter)

TSE

TS ISO 6788

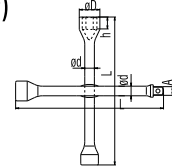

Special steel, Chrom plated

| CODE | mm | inch | σD mm | h mm | L mm | A mm | σd mm | g | □ |
|--------------|----|--------|----------|---------|---------|---------|----------|------|----|
| | 17 | 11/16" | 28 | 17 | | | | | |
| 1975 09 1322 | 19 | 3/4" | 30 | 18.5 | 420 | 12.65 | 16 | 1375 | 10 |
| | 22 | 7/8" | 34 | 20.5 | | | | | |
| | | 1/2" | | | | | | | |

1940

Offset Socket Wrench with Screwdriver

TSEK

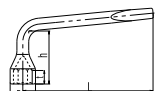

Special steel, Chrom plated

| CODE | mm | inch | L mm | σD mm | h mm | g | □ |
|--------------|----|--------|---------|----------|---------|-----|----|
| 1940 09 0017 | 17 | 11/16" | 285 | 28 | 65 | 485 | 10 |
| 1940 09 0019 | 19 | 3/4" | 285 | 30 | 65 | 470 | 10 |
| 1940 09 0021 | 21 | 13/16" | 320 | 32 | 85 | 575 | 10 |

1840 08 0500

Swivel Handle With Sliding T 1/2"

1/2"

Special steel, Chrom plated

| CODE | mm | L mm | g | □ |
|--------------|------|---------|-----|----|
| 1840 08 0500 | 1/2" | 600 | 740 | 10 |

1610

Torque Wrench

TS EN ISO 6789-1
TS EN ISO 6789-2



3/8"

| CODE | SIZE | L mm | g | |
|--------------|----------------------------|---------|-----|---|
| 1610 06 0100 | 2.5 - 11 Nm - 0.3 - 1.2 Kg | 310 | 515 | 1 |
| 1610 06 0300 | 7 - 33 Nm - 0.5 - 3.4 Kg | 425 | 640 | 1 |

1613

Torque Wrench

TS EN ISO 6789-1
TS EN ISO 6789-2



1/2"

| CODE | SIZE | L mm | g | |
|--------------|-------------------------|---------|------|---|
| 1613 06 1200 | 25 - 135 Nm - 3 - 14 Kg | 550 | 1430 | 1 |
| 1613 06 2000 | 50 - 225 Nm - 5 - 23 Kg | 600 | 2165 | 1 |
| 1613 06 3000 | 70 - 330 Nm - 7 - 35 Kg | 830 | 2870 | 1 |

1619 06 2080

Torque Wrench

TS EN ISO 6789-1
TS EN ISO 6789-2



3/4"



İZELTAS USTA İŞİ
SOHBETLER

| CODE | SIZE | L mm | g | |
|--------------|---------------------------|---------|------|---|
| 1619 06 2080 | 200 - 800 Nm - 22 - 82 kg | 1030 | 8860 | 1 |

1607 06 0420

Torque Wrench With Reversible Ratchet-Head

TS EN ISO 6789-1
TS EN ISO 6789-2



İZELTAS YOUTUBE

1/4"

| CODE | SIZE | L mm | g | |
|--------------|-----------|---------|-----|---|
| 1607 06 0420 | 4 - 20 Nm | 320 | 640 | 1 |

1610 06 2010

Torque Wrench With Reversible Ratchet-Head

TS EN ISO 6789-1
TS EN ISO 6789-2



3/8"

| CODE | SIZE | L mm | g | |
|--------------|-------------|---------|------|---|
| 1610 06 2010 | 20 - 100 Nm | 435 | 1300 | 1 |

1613

Torque Wrench With Reversible Ratchet-Head

TS EN ISO 6789-1
TS EN ISO 6789-2



1/2"

| CODE | SIZE | L mm | g | |
|--------------|-------------|---------|------|---|
| 1613 06 4020 | 40 - 200 Nm | 520 | 1590 | 1 |
| 1613 06 6034 | 60 - 340 Nm | 610 | 1810 | 1 |

1619 06 1060

Torque Wrench With Reversible Ratchet-Head

TS EN ISO 6789-1
TS EN ISO 6789-2



3/4"

| CODE | SIZE | L mm | g | |
|--------------|--------------|---------|------|---|
| 1619 06 1060 | 100 - 600 Nm | 1050 | 5600 | 1 |

RATCHET HANDLE





IMPACT SOCKET

Impact Socket Wrenches



Impact Socket Wrench 6 Points (mm)

TS ISO 2725-2

Impact Socket Wrench 6 Points Long Type (mm)

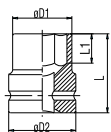

3/8"

Phosphate finish

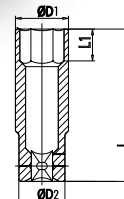

3/8"

Phosphate finish

| CODE | mm | Ø D1 mm | Ø D2 mm | L mm | L1 mm | g | |
|--------------|----|---------|---------|------|-------|----|----|
| 14000 004583 | 6 | 10.6 | 19 | 32 | 5 | 33 | 10 |
| 14000 004584 | 7 | 11.8 | 19 | 32 | 5 | 33 | 10 |
| 14000 004585 | 8 | 13.2 | 19 | 32 | 6 | 35 | 10 |
| 14000 004586 | 9 | 14.5 | 19 | 32 | 6 | 35 | 10 |
| 14000 004587 | 10 | 15.5 | 19 | 32 | 7 | 40 | 10 |
| 14000 004588 | 11 | 17 | 19 | 32 | 7 | 40 | 10 |
| 14000 004589 | 12 | 18.2 | 19 | 32 | 8 | 40 | 10 |
| 14000 004590 | 13 | 19.4 | 22 | 32 | 9 | 55 | 10 |
| 14000 004591 | 14 | 20.7 | 22 | 32 | 9 | 55 | 10 |
| 14000 004592 | 15 | 22 | 22 | 32 | 10 | 55 | 10 |
| 14000 004593 | 16 | 23.8 | 22 | 32 | 10 | 60 | 10 |
| 14000 004594 | 17 | 24.8 | 22 | 32 | 11 | 60 | 10 |
| 14000 004595 | 18 | 25.8 | 22 | 32 | 11 | 60 | 10 |
| 14000 004596 | 19 | 27.6 | 22 | 32 | 13 | 65 | 10 |
| 14000 004597 | 20 | 28.3 | 22 | 32 | 13 | 70 | 10 |
| 14000 004598 | 21 | 29.5 | 22 | 32 | 13 | 75 | 10 |
| 14000 004599 | 22 | 30.8 | 22 | 32 | 13 | 85 | 10 |
| 14000 004600 | 23 | 32 | 22 | 32 | 13 | 90 | 10 |

| CODE | mm | Ø D1 mm | Ø D2 mm | L mm | L1 mm | g | |
|---------------|----|---------|---------|------|-------|-----|----|
| 14000 004601 | 6 | 10.6 | 19 | 65 | 10 | 50 | 10 |
| 14000 004602 | 7 | 11.8 | 19 | 65 | 10 | 55 | 10 |
| 14000 004603 | 8 | 13.2 | 19 | 65 | 12 | 70 | 10 |
| 14000 004604 | 9 | 14.5 | 19 | 65 | 12 | 65 | 10 |
| 14000 004605 | 10 | 15.5 | 19 | 65 | 12 | 80 | 10 |
| 114000 004606 | 11 | 17 | 19 | 65 | 13 | 75 | 10 |
| 14000 004607 | 12 | 18.2 | 19 | 65 | 14 | 90 | 10 |
| 14000 004608 | 13 | 19.4 | 22 | 65 | 14 | 100 | 10 |
| 14000 004609 | 14 | 20.7 | 22 | 65 | 14 | 110 | 10 |
| 14000 004610 | 15 | 22 | 22 | 65 | 16 | 110 | 10 |
| 14000 004611 | 16 | 23.8 | 22 | 65 | 16 | 125 | 10 |
| 14000 004612 | 17 | 24.8 | 22 | 65 | 17 | 145 | 10 |
| 14000 004613 | 18 | 25.8 | 22 | 65 | 18 | 135 | 10 |
| 14000 004614 | 19 | 27.6 | 22 | 65 | 20 | 170 | 10 |
| 14000 004615 | 20 | 28.3 | 22 | 65 | 20 | 155 | 10 |
| 14000 004616 | 21 | 29.5 | 22 | 65 | 22 | 160 | 10 |
| 14000 004617 | 22 | 30.8 | 22 | 65 | 22 | 180 | 10 |
| 14000 004618 | 23 | 32 | 22 | 65 | 24 | 180 | 10 |



1113 00 9003

Impact Socket Extension Bar

TS ISO 1174-2



3/8"

Phosphate finish

| CODE | L mm | g | |
|--------------|------|-----|----|
| 14000 004619 | 75 | 100 | 10 |
| 14000 004620 | 125 | 150 | 10 |

Impact Socket Wrench 6 Points (mm)



1/2"

| CODE | Sockets | g | |
|--------------|----------|-----|---|
| 1113 00 9003 | 17-19-21 | 800 | 3 |

14000 004621

Impact Socket Adapter



3/8"

Phosphate finish

| CODE | inch | g | |
|--------------|-------------|----|----|
| 14000 004621 | 3/8"Fx1/2"M | 55 | 10 |

14000 004622

Impact Socket Universal Joint



3/8"

, Phosphate finish

| CODE | inch | g | |
|--------------|------|----|----|
| 14000 004622 | 3/8" | 90 | 10 |

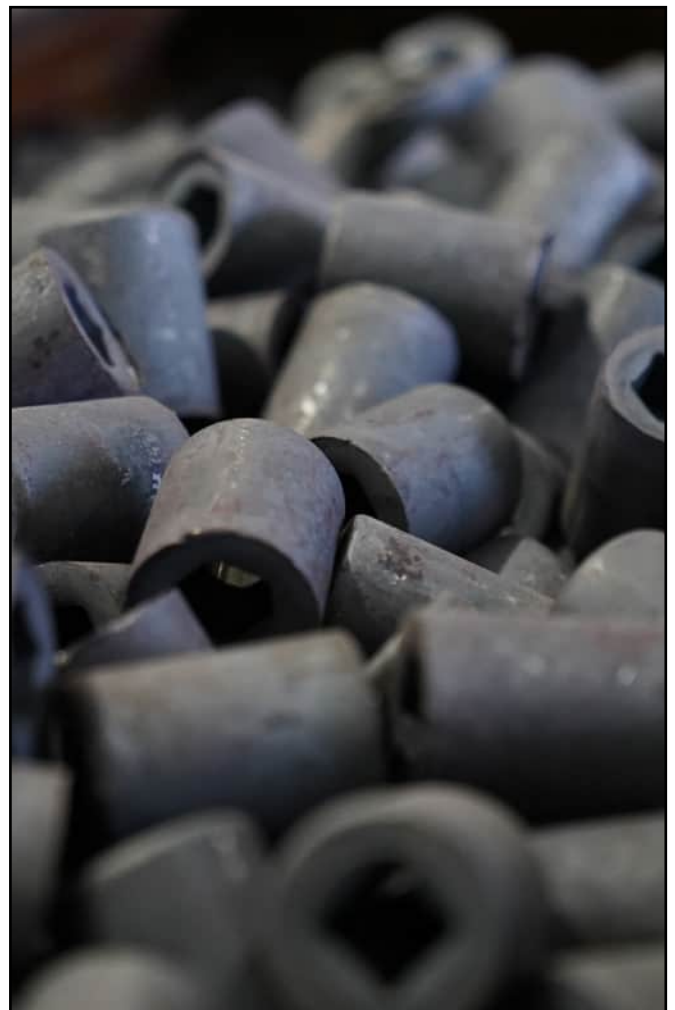

Impact Socket Wrench 6 Points (mm)

TS ISO 2725-2



İZELTAS YOUTUBE

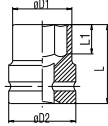

1/2"

Phosphate finish

| CODE | mm | σ D1 mm | σ D2 mm | L mm | L1 mm | g | |
|--------------|----|---------|---------|------|-------|-----|----|
| 1113 06 7008 | 8 | 15 | 25 | 38 | 7 | 65 | 10 |
| 1113 06 7009 | 9 | 16.5 | 25 | 38 | 7 | 70 | 10 |
| 1113 06 7010 | 10 | 17.6 | 25 | 38 | 8 | 70 | 10 |
| 1113 06 7011 | 11 | 18.8 | 25 | 38 | 8 | 70 | 10 |
| 1113 06 7012 | 12 | 20 | 25 | 38 | 9 | 75 | 10 |
| 1113 06 7013 | 13 | 21.2 | 25 | 38 | 10 | 75 | 10 |
| 1113 06 7014 | 14 | 22.5 | 25 | 38 | 10 | 80 | 10 |
| 1113 06 7015 | 15 | 23.8 | 30 | 38 | 11 | 115 | 10 |
| 1113 06 7016 | 16 | 25 | 30 | 38 | 11 | 120 | 10 |
| 1113 06 7017 | 17 | 26.2 | 30 | 38 | 12 | 120 | 10 |
| 1113 06 7018 | 18 | 27.5 | 30 | 38 | 13 | 125 | 10 |
| 1113 06 7019 | 19 | 28.8 | 30 | 38 | 13 | 115 | 10 |
| 1113 06 7020 | 20 | 29.5 | 30 | 38 | 13 | 115 | 10 |
| 1113 06 7021 | 21 | 30 | 30 | 40 | 14 | 120 | 10 |
| 1113 06 7022 | 22 | 32.4 | 30 | 40 | 14 | 130 | 10 |
| 1113 06 7023 | 23 | 33.2 | 30 | 40 | 15 | 145 | 10 |
| 1113 06 7024 | 24 | 34.4 | 30 | 42 | 15 | 140 | 10 |
| 1113 06 7025 | 25 | 36 | 30 | 42 | 15 | 155 | 10 |
| 1113 06 7026 | 26 | 37 | 30 | 42 | 15 | 175 | 10 |
| 1113 06 7027 | 27 | 37.8 | 30 | 44 | 16 | 175 | 10 |
| 1113 06 7028 | 28 | 39.8 | 30 | 44 | 16 | 205 | 10 |
| 1113 06 7029 | 29 | 39.8 | 30 | 44 | 17 | 200 | 10 |
| 1113 06 7030 | 30 | 41.8 | 30 | 44 | 17 | 205 | 10 |
| 1113 06 7032 | 32 | 46 | 30 | 44 | 19 | 240 | 10 |

Impact Socket Wrench 6 Point, Long Type (mm)

TS ISO 2725-2

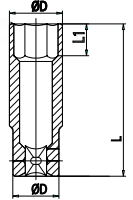

1/2"

Phosphate finish

| CODE | mm | σ D1 mm | σ D2 mm | L mm | L1 mm | g | |
|--------------|----|---------|---------|------|-------|-----|----|
| 1108 06 7008 | 8 | 15 | 24.8 | 78 | 12 | 125 | 10 |
| 1108 06 7009 | 9 | 16.3 | 24.8 | 78 | 12 | 135 | 10 |
| 1108 06 7010 | 10 | 17.6 | 24.8 | 80 | 12 | 150 | 10 |
| 1108 06 7011 | 11 | 18.8 | 24.8 | 80 | 13 | 155 | 10 |
| 1108 06 7012 | 12 | 20 | 24.8 | 80 | 14 | 165 | 10 |
| 1108 06 7013 | 13 | 21.2 | 24.8 | 80 | 14 | 170 | 10 |
| 1108 06 7014 | 14 | 22.5 | 24.8 | 80 | 14 | 170 | 10 |
| 1108 06 7015 | 15 | 23.8 | 29.8 | 80 | 16 | 225 | 10 |
| 1108 06 7016 | 16 | 25 | 29.8 | 80 | 16 | 235 | 10 |
| 1108 06 7017 | 17 | 26.2 | 29.8 | 80 | 16 | 240 | 10 |
| 1108 06 7018 | 18 | 27.5 | 29.8 | 80 | 17 | 245 | 10 |
| 1108 06 7019 | 19 | 28.8 | 29.8 | 80 | 18 | 255 | 10 |
| 1108 06 7020 | 20 | 29 | 29.8 | 80 | 20 | 245 | 10 |
| 1108 06 7021 | 21 | 29.8 | 29.8 | 80 | 20 | 245 | 10 |
| 1108 06 7022 | 22 | 32.4 | 30 | 80 | 22 | 280 | 10 |
| 1108 06 7023 | 23 | 33.2 | 30 | 80 | 24 | 315 | 10 |
| 1108 06 7024 | 24 | 34.4 | 30 | 80 | 24 | 295 | 10 |
| 1108 06 7025 | 25 | 36 | 30 | 80 | 24 | 325 | 10 |
| 1108 06 7026 | 26 | 37 | 30 | 80 | 27 | 365 | 10 |
| 1108 06 7027 | 27 | 37.8 | 30 | 80 | 27 | 365 | 10 |
| 1108 06 7028 | 28 | 39.8 | 30 | 80 | 27 | 425 | 10 |
| 1108 06 7029 | 29 | 39.8 | 30 | 80 | 27 | 405 | 10 |
| 1108 06 7030 | 30 | 41.8 | 30 | 80 | 30 | 420 | 10 |
| 1108 06 7032 | 32 | 46 | 30 | 80 | 32 | 505 | 10 |

Impact Socket Star (Torx®) Wrench



Phosphate finish

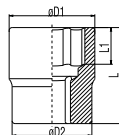

1/2"

| CODE | | σ D1 mm | σ D2 mm | L mm | L1 mm | g | |
|--------------|-----|---------|---------|------|-------|-----|----|
| 14000 004539 | E10 | 14 | 25 | 38 | 7.5 | 70 | 10 |
| 14000 005160 | E12 | 15.9 | 25 | 38 | 9 | 70 | 10 |
| 14000 004540 | E14 | 17.7 | 25 | 38 | 10 | 70 | 10 |
| 14000 004541 | E16 | 20 | 25 | 38 | 11 | 75 | 10 |
| 14000 004542 | E18 | 22 | 25 | 38 | 12.5 | 80 | 10 |
| 14000 004543 | E20 | 24.5 | 30 | 38 | 14 | 120 | 10 |
| 14000 004544 | E22 | 26 | 30 | 38 | 15 | 120 | 10 |
| 14000 004545 | E24 | 28 | 30 | 38 | 16 | 120 | 10 |

Impact Socket Hexagonal Bits Socket Wrench



1/2"

Phosphate finish

| CODE | mm | L mm | g | |
|--------------|-----|------|-----|----|
| 14000 004546 | H4 | 80 | 70 | 10 |
| 14000 004547 | H5 | 80 | 75 | 10 |
| 14000 004548 | H6 | 80 | 75 | 10 |
| 14000 004549 | H8 | 80 | 85 | 10 |
| 14000 004550 | H10 | 80 | 100 | 10 |
| 14000 004551 | H12 | 80 | 120 | 10 |
| 14000 004552 | H14 | 80 | 140 | 10 |
| 14000 004553 | H17 | 80 | 220 | 10 |
| 14000 004554 | H19 | 80 | 245 | 10 |

1513 06 7125

TS ISO 1174-2

Impact Socket Extension Bar



1/2"

Phosphate finish

| CODE | L mm | g | |
|--------------|------|-----|---|
| 1513 06 7125 | 125 | 275 | 5 |

1513

Impact Socket Adapter



1/2"

Phosphate finish

| CODE | inch | g | |
|--------------|-------------|-----|---|
| 1513 06 7002 | 1/2"Fx3/8"M | 95 | 5 |
| 1513 06 7003 | 1/2"Fx3/4"M | 175 | 5 |

1513 06 7075

Impact Socket Star (Torx®) Bits Socket Wrench



1/2"

Phosphate finish

| CODE | | L mm | g | |
|--------------|-----|------|-----|----|
| 14000 004573 | T20 | 100 | 70 | 10 |
| 14000 004574 | T25 | 100 | 70 | 10 |
| 14000 004575 | T27 | 100 | 75 | 10 |
| 14000 004576 | T30 | 100 | 75 | 10 |
| 14000 004577 | T40 | 100 | 80 | 10 |
| 14000 004578 | T45 | 100 | 90 | 10 |
| 14000 004579 | T50 | 100 | 100 | 10 |
| 14000 004580 | T55 | 100 | 120 | 10 |
| 14000 004581 | T60 | 100 | 140 | 10 |
| 14000 004582 | T80 | 100 | 180 | 10 |

Impact Socket Universal Joint



1/2"

Phosphate finish

| CODE | L mm | g | |
|--------------|------|-----|---|
| 1513 06 7075 | 75 | 220 | 5 |

Impact Socket Wrench 6 Points (mm)

TS ISO 2725-2

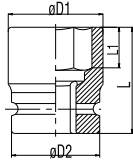

Phosphate finish



| CODE | mm | σ D1 mm | σ D2 mm | L mm | L1 mm | g | |
|--------------|----|---------|---------|------|-------|------|---|
| 1119 06 7017 | 17 | 29 | 44 | 50 | 10 | 310 | 5 |
| 1119 06 7018 | 18 | 30 | 44 | 50 | 10 | 315 | 5 |
| 1119 06 7019 | 19 | 32 | 44 | 50 | 10 | 325 | 5 |
| 1119 06 7020 | 20 | 33 | 44 | 50 | 10 | 335 | 5 |
| 1119 06 7021 | 21 | 35 | 44 | 50 | 13 | 335 | 5 |
| 1119 06 7022 | 22 | 36 | 44 | 50 | 13 | 340 | 5 |
| 1119 06 7023 | 23 | 37 | 44 | 50 | 15 | 340 | 5 |
| 1119 06 7024 | 24 | 38 | 44 | 50 | 15 | 345 | 5 |
| 1119 06 7025 | 25 | 41 | 44 | 53 | 15 | 365 | 5 |
| 1119 06 7026 | 26 | 40 | 44 | 53 | 15 | 365 | 5 |
| 1119 06 7027 | 27 | 42 | 44 | 53 | 18 | 380 | 5 |
| 1119 06 7028 | 28 | 44 | 44 | 53 | 18 | 390 | 5 |
| 1119 06 7029 | 29 | 45 | 44 | 53 | 18 | 400 | 5 |
| 1119 06 7030 | 30 | 46 | 44 | 53 | 20 | 350 | 1 |
| 1119 06 7032 | 32 | 48 | 44 | 57 | 20 | 455 | 1 |
| 1119 06 7033 | 33 | 50 | 44 | 57 | 20 | 480 | 1 |
| 1119 06 7034 | 34 | 51 | 44 | 57 | 22 | 490 | 1 |
| 1119 06 7035 | 35 | 53 | 44 | 57 | 22 | 500 | 1 |
| 1119 06 7036 | 36 | 53 | 44 | 57 | 22 | 510 | 1 |
| 1119 06 7038 | 38 | 56 | 44 | 57 | 22 | 555 | 1 |
| 1119 06 7041 | 41 | 59 | 44 | 58 | 24 | 585 | 1 |
| 1119 06 7044 | 44 | 64 | 44 | 62 | 24 | 706 | 1 |
| 1119 06 7046 | 46 | 66 | 44 | 62 | 24 | 730 | 1 |
| 1119 06 7050 | 50 | 71 | 44 | 65 | 26 | 870 | 1 |
| 1119 06 7055 | 55 | 77 | 54 | 70 | 30 | 1200 | 1 |
| 1119 06 7060 | 60 | 84 | 54 | 70 | 32 | 1425 | 1 |

Impact Socket Wrench 6 Points, Long Type (mm)

TS ISO 2725-2

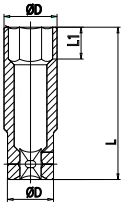

Phosphate finish



| CODE | mm | σ D1 mm | σ D2 mm | L mm | L1 mm | g | |
|--------------|----|---------|---------|------|-------|------|---|
| 14000 004504 | 17 | 29 | 44 | 90 | 15 | 480 | 5 |
| 14000 004505 | 18 | 30 | 44 | 90 | 15 | 500 | 5 |
| 14000 004506 | 19 | 32 | 44 | 90 | 16 | 545 | 5 |
| 14000 004507 | 20 | 32 | 44 | 90 | 17 | 545 | 5 |
| 14000 004508 | 21 | 35 | 44 | 90 | 18 | 565 | 5 |
| 14000 004509 | 22 | 36 | 44 | 90 | 18 | 580 | 5 |
| 14000 004510 | 23 | 37 | 44 | 90 | 23 | 600 | 5 |
| 14000 004511 | 24 | 38 | 44 | 90 | 23 | 600 | 5 |
| 14000 004512 | 25 | 40 | 44 | 90 | 25 | 630 | 5 |
| 14000 004513 | 26 | 40 | 44 | 90 | 25 | 600 | 5 |
| 14000 004514 | 27 | 42 | 44 | 90 | 27 | 625 | 5 |
| 14000 004515 | 28 | 44 | 44 | 90 | 27 | 665 | 5 |
| 14000 004516 | 29 | 45 | 44 | 90 | 27 | 665 | 5 |
| 14000 004517 | 30 | 46 | 44 | 90 | 27 | 695 | 1 |
| 14000 004518 | 32 | 48 | 44 | 90 | 30 | 730 | 1 |
| 14000 004519 | 33 | 50 | 44 | 90 | 30 | 790 | 1 |
| 14000 004520 | 34 | 51 | 44 | 90 | 32 | 795 | 1 |
| 14000 004521 | 35 | 52 | 44 | 90 | 32 | 810 | 1 |
| 14000 004522 | 36 | 53 | 44 | 90 | 32 | 820 | 1 |
| 14000 004523 | 38 | 56 | 44 | 90 | 34 | 880 | 1 |
| 14000 004524 | 41 | 59 | 44 | 90 | 34 | 935 | 1 |
| 14000 004525 | 46 | 66 | 44 | 95 | 38 | 1240 | 1 |
| 14000 004526 | 50 | 71 | 44 | 95 | 40 | 1315 | 1 |
| 14000 004527 | 55 | 77 | 54 | 100 | 45 | 1800 | 1 |

Impact Socket Hexagonal Bits Socket Wrench

, Phosphate finish



| CODE | mm | L mm | g | |
|--------------|-----|------|-----|----|
| 14000 004528 | H14 | 87 | 310 | 5 |
| 14000 004529 | H17 | 87 | 340 | 5 |
| 14000 004530 | H19 | 87 | 365 | 5 |
| 14000 004531 | H21 | 87 | 510 | 5 |
| 14000 004532 | H22 | 87 | 525 | 5 |
| 14000 004533 | H24 | 87 | 545 | 5 |
| 14000 004534 | H27 | 87 | 600 | 5 |
| 14000 004535 | H30 | 87 | 710 | 1 |
| 14000 004536 | H32 | 87 | 750 | 1 |
| 14000 004537 | H36 | 87 | 830 | 10 |

1519

Impact Socket Extension Bar

TS ISO 1174-2



1519 06 7108

Impact Socket Universal Joint



3/4"

Phosphate finish

| CODE | L mm | g | □ |
|--------------|---------|------|---|
| 1519 06 7175 | 175 | 865 | 5 |
| 1519 06 7250 | 250 | 1155 | 5 |
| 1519 06 7330 | 330 | 1425 | 5 |

3/4"

Chrom molybdenum, Phosphate finish

| CODE | L mm | g | □ |
|--------------|---------|-----|---|
| 1519 06 7108 | 108 | 735 | 5 |

1519

Impact Socket Adapter



3/4"

Phosphate finish

| CODE | inch | g | □ |
|--------------|-------------|-----|---|
| 1519 06 7011 | 3/4"Fx1/2"M | 315 | 5 |
| 1519 06 7012 | 3/4"Fx1"M | 445 | 5 |

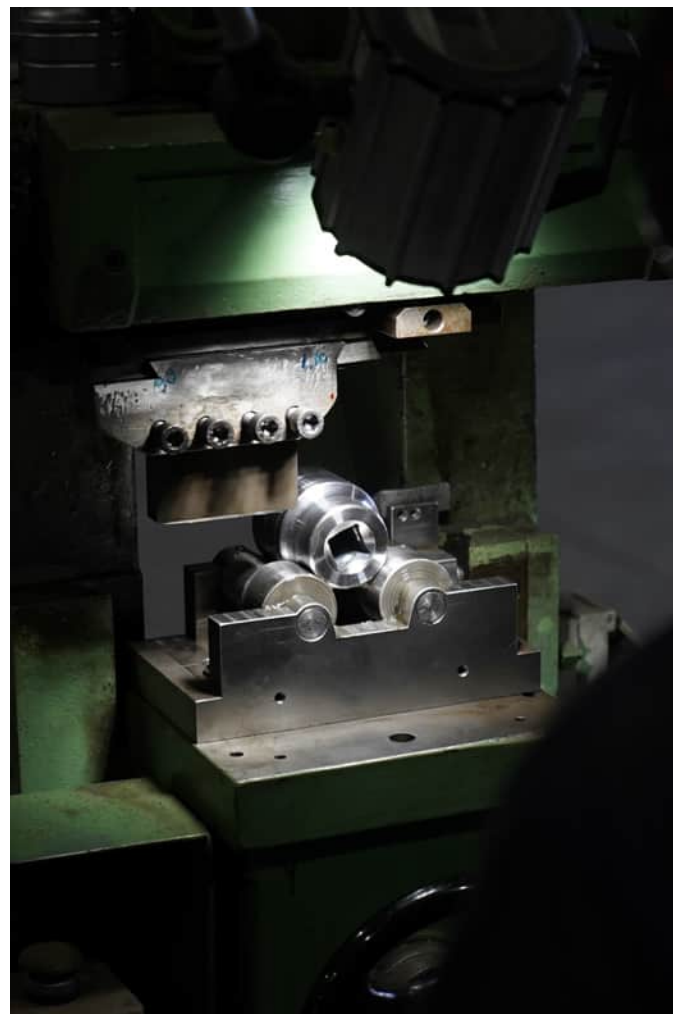

Impact Socket Wrench 6 Points (mm)

TS ISO 2725-2

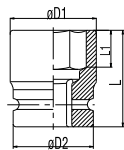

1"

Phosphate finish

| CODE | mm | $\sigma D1$ mm | $\sigma D2$ mm | L mm | L1 mm | g | |
|--------------|----|----------------|----------------|------|-------|------|---|
| 1125 06 7021 | 21 | 37 | 54 | 58 | 15 | 540 | 1 |
| 1125 06 7022 | 22 | 38 | 54 | 58 | 15 | 550 | 1 |
| 1125 06 7023 | 23 | 39 | 54 | 58 | 17 | 545 | 1 |
| 1125 06 7024 | 24 | 41 | 54 | 58 | 17 | 560 | 1 |
| 1125 06 7025 | 25 | 42 | 54 | 58 | 17 | 560 | 1 |
| 1125 06 7026 | 26 | 43 | 54 | 58 | 19 | 565 | 1 |
| 1125 06 7027 | 27 | 44 | 54 | 58 | 19 | 565 | 1 |
| 1125 06 7028 | 28 | 45 | 54 | 58 | 19 | 570 | 1 |
| 1125 06 7029 | 29 | 47 | 54 | 58 | 19 | 590 | 1 |
| 1125 06 7030 | 30 | 48 | 54 | 60 | 20 | 590 | 1 |
| 1125 06 7032 | 32 | 51 | 54 | 62 | 20 | 645 | 1 |
| 1125 06 7033 | 33 | 52 | 54 | 62 | 20 | 660 | 1 |
| 1125 06 7034 | 34 | 53 | 54 | 62 | 20 | 665 | 1 |
| 1125 06 7035 | 35 | 54 | 54 | 62 | 20 | 665 | 1 |
| 1125 06 7036 | 36 | 56 | 54 | 65 | 20 | 720 | 1 |
| 1125 06 7038 | 38 | 58 | 54 | 65 | 22 | 735 | 1 |
| 1125 06 7041 | 41 | 61 | 54 | 70 | 22 | 825 | 1 |
| 1125 06 7046 | 46 | 68 | 54 | 75 | 26 | 1035 | 1 |
| 1125 06 7048 | 48 | 70 | 54 | 75 | 26 | 1060 | 1 |
| 1125 06 7050 | 50 | 73 | 54 | 75 | 26 | 1170 | 1 |
| 1125 06 7055 | 55 | 79 | 54 | 83 | 32 | 1435 | 1 |
| 1125 06 7060 | 60 | 86 | 54 | 87 | 32 | 1695 | 1 |
| 1125 06 7065 | 65 | 92 | 54 | 90 | 34 | 1750 | 1 |
| 1125 06 7070 | 70 | 97 | 54 | 93 | 34 | 2035 | 1 |
| 1125 06 7075 | 75 | 104 | 86 | 95 | 36 | 3120 | 1 |
| 1125 06 7080 | 80 | 110 | 86 | 95 | 43 | 3390 | 1 |
| 1125 06 7085 | 85 | 115 | 86 | 95 | 43 | 3530 | 1 |
| 1125 06 7090 | 90 | 122 | 86 | 100 | 43 | 4005 | 1 |

Impact Socket Wrench 6 Points, Long Type (mm)

TS ISO 2725-2

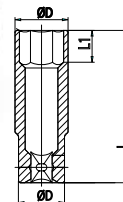

1"

Phosphate finish

| CODE | mm | $\sigma D1$ mm | $\sigma D2$ mm | L mm | L1 mm | g | |
|--------------|----|----------------|----------------|------|-------|------|---|
| 14000 004462 | 21 | 38 | 54 | 90 | 25 | 810 | 1 |
| 14000 004463 | 22 | 39 | 54 | 90 | 25 | 840 | 1 |
| 14000 004464 | 23 | 40 | 54 | 90 | 25 | 850 | 1 |
| 14000 004465 | 24 | 41 | 54 | 90 | 25 | 875 | 1 |
| 14000 004466 | 25 | 42 | 54 | 90 | 25 | 890 | 1 |
| 14000 004467 | 26 | 43 | 54 | 90 | 25 | 910 | 1 |
| 14000 004468 | 27 | 44 | 54 | 90 | 25 | 870 | 1 |
| 14000 004469 | 28 | 45 | 54 | 90 | 25 | 890 | 1 |
| 14000 004470 | 29 | 47 | 54 | 90 | 15 | 900 | 1 |
| 14000 004471 | 30 | 48 | 54 | 90 | 28 | 910 | 1 |
| 14000 004472 | 32 | 51 | 54 | 90 | 28 | 955 | 1 |
| 14000 004473 | 33 | 51 | 54 | 92 | 28 | 1015 | 1 |
| 14000 004474 | 34 | 53 | 54 | 92 | 28 | 990 | 1 |
| 14000 004475 | 35 | 54 | 54 | 92 | 28 | 1020 | 1 |
| 14000 004476 | 36 | 56 | 54 | 92 | 32 | 1035 | 1 |
| 14000 004477 | 38 | 58 | 54 | 92 | 32 | 1050 | 1 |
| 14000 004478 | 41 | 61 | 54 | 92 | 32 | 1095 | 1 |
| 14000 004479 | 46 | 68 | 54 | 95 | 35 | 1330 | 1 |
| 14000 004480 | 50 | 73 | 54 | 95 | 35 | 1380 | 1 |
| 14000 004481 | 55 | 70 | 54 | 100 | 40 | 1705 | 1 |
| 14000 004482 | 60 | 86 | 54 | 100 | 42 | 2020 | 1 |
| 14000 004483 | 65 | 92 | 54 | 110 | 50 | 2135 | 1 |
| 14000 004484 | 70 | 97 | 54 | 110 | 59 | 2285 | 1 |
| 14000 004485 | 75 | 104 | 86 | 120 | 60 | 3400 | 1 |
| 14000 004486 | 80 | 110 | 86 | 120 | 60 | 4200 | 1 |
| 14000 004487 | 85 | 115 | 86 | 120 | 60 | 3980 | 1 |
| 14000 004488 | 90 | 122 | 86 | 125 | 65 | 5000 | 1 |



1525

TS ISO 1174-2

Impact Socket Extension Bar



1"

Phosphate finish

| CODE | L mm | g | |
|--------------|---------|-------|---|
| 1525 06 7175 | 175 | 1395 | 5 |
| 1525 06 7250 | 250 | 1890 | 5 |
| 1525 06 7330 | 330 | 2455 | 5 |

1525 06 7128

Impact Socket Universal Joint



1"

Phosphate finish

| CODE | L mm | g | |
|--------------|---------|-------|---|
| 1525 06 7128 | 128 | 1530 | 1 |

1525 06 7015

Impact Socket Adapter



1"

Phosphate finish

| CODE | inch | g | |
|--------------|-----------|-------|---|
| 1525 06 7015 | 1"Fx3/4"M | 560 | 5 |





PIPE WRENCHES AND PLIERS

Pipe Wrenches

Water Pump Pliers

Grip Wrenches

Pliers

Nose Pliers

Carpenter Pincers

Electronic Pliers



COMBINATION PLIERS



2100

Pipe Wrench, Stilson



TS 3796



Spare parts page 228

Teeth induction hardened, Electrostatically painted

| CODE | L mm | L inch | mm | SIZE mm | g | |
|--------------|------|--------|----|---------|------|---|
| 2100 10 0008 | 200 | 8" | 27 | 6-20 | 280 | 1 |
| 2100 10 0010 | 250 | 10" | 34 | 6-26 | 550 | 1 |
| 2100 10 0012 | 300 | 12" | 42 | 10-32 | 725 | 1 |
| 2100 10 0014 | 350 | 14" | 50 | 13-38 | 1030 | 1 |
| 2100 10 0018 | 450 | 18" | 60 | 26-52 | 1775 | 1 |
| 2100 10 0024 | 600 | 24" | 76 | 38-65 | 2775 | 1 |

2201

Pipe Wrench (85 °)



TS 3796
DIN 5234



Spare parts page 228

Teeth induction hardened, Electrostatically painted

| CODE | L mm | mm | SIZE Inch | g | |
|--------------|------|-----|-----------|------|---|
| 2201 10 0010 | 325 | 40 | 1" | 870 | 1 |
| 2201 10 0015 | 430 | 60 | 1 1/2" | 1585 | 1 |
| 2201 10 0020 | 585 | 70 | 2" | 2700 | 1 |
| 2201 10 0030 | 690 | 100 | 3" | 4270 | 1 |
| 2201 10 0040 | 760 | 130 | 4" | 5800 | 1 |

2110

Pipe Wrench, Heavy Duty



Spare parts page 228

Teeth induction hardened, Electrostatically painted

| CODE | L mm | L inch | mm | SIZE Inch | g | |
|--------------|------|--------|-----|-----------|-------|---|
| 2110 10 0008 | 200 | 8" | 34 | 1" | 425 | 1 |
| 2110 10 0010 | 250 | 10" | 42 | 1 1/4" | 795 | 1 |
| 2110 10 0012 | 300 | 12" | 50 | 1 1/2" | 1245 | 1 |
| 2110 10 0014 | 350 | 14" | 60 | 2" | 1710 | 1 |
| 2110 10 0018 | 450 | 18" | 75 | 2 1/2" | 2685 | 1 |
| 2110 10 0024 | 600 | 24" | 90 | 3" | 4370 | 1 |
| 2110 10 0036 | 900 | 36" | 140 | 5" | 7600 | 1 |
| 2110 10 0048 | 1200 | 48" | 165 | 6" | 15600 | 1 |

Chain Pipe Wrench



Spare parts page 228

Teeth induction hardened, Electrostatically painted

| CODE | L mm | mm | SIZE Inch | g | |
|--------------|------|-----|-----------|-------|---|
| 14000 005036 | 940 | 115 | 4" | 4770 | 1 |
| 14000 005037 | 1125 | 165 | 6" | 8580 | 1 |
| 14000 005140 | 1280 | 220 | 8" | 12820 | 1 |

Spare Chain For Chain Pipe Wrench



| CODE | SIZE Inch | L mm | g | |
|--------------|-----------|------|------|---|
| 14000 005039 | 4" | 555 | 840 | 1 |
| 14000 005040 | 6" | 785 | 1635 | 1 |
| 14000 005139 | 8" | 990 | 2400 | 1 |

Waterpump Pliers Universal



TS 60 TS ISO 8976
DIN ISO 8976



IZELTAS YOUTUBE

Chrom plated, PVC insulated

| CODE | L mm | L inch | mm | g | |
|--------------|------|---------|----|-----|---|
| 2400 11 0160 | 160 | 6 1/4" | 30 | 125 | 5 |
| 2400 11 0240 | 240 | 9 1/2" | 35 | 355 | 5 |
| 2400 11 0315 | 315 | 12 1/2" | 40 | 530 | 5 |

2400 11 6240

Insulated Type Waterpump Pliers Universal 1000V

TS 60
TS ISO 8976
⚡ 1000 V
IEC 60900



Chrom vanadium, Chrom plated, Two component handle

| CODE | L mm | L inch | mm | g | |
|--------------|------|--------|----|-----|---|
| 2400 11 6240 | 240 | 9 1/2" | 35 | 370 | 5 |

Waterpump Pliers With Spring



IZELTAS USTA ISI
SOHBETLER

Black finish, PVC insulated

| CODE | L mm | L inch | mm | g | |
|--------------|------|--------|----|-----|---|
| 2415 11 0240 | 240 | 9 1/2" | 35 | 365 | 5 |

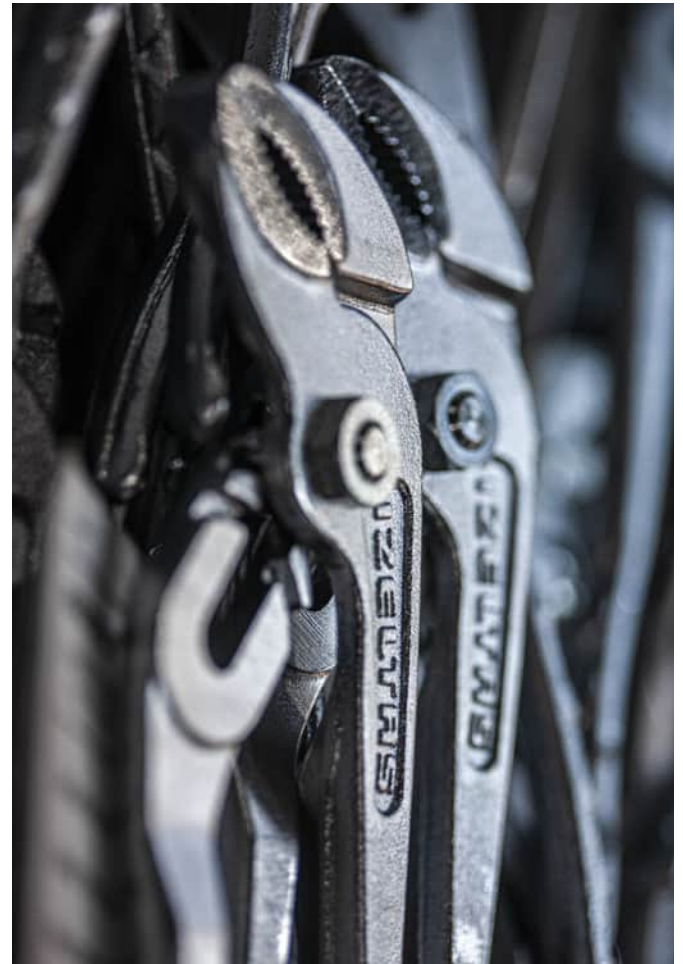

2500 11 0250

Universal Grip



Nickel plated
Application field : Flat and round materials

| CODE | L mm | L inch | mm | g | |
|--------------|------|--------|----|-----|---|
| 2500 11 0250 | 250 | 10" | 30 | 560 | 5 |

2510 11 0250

Special Grip



Nickel plated
Application field: Flat and round materials

| CODE | L mm | L inch | mm | g | |
|--------------|------|--------|----|-----|---|
| 2510 11 0250 | 250 | 10" | 30 | 550 | 5 |

2505 11 0250

Standard Grip



Nickel plated
Application field: Flat materials

| CODE | L mm | L inch | mm | g | |
|--------------|------|--------|----|-----|---|
| 2505 11 0250 | 250 | 10" | 30 | 535 | 5 |

2511 11 0280

Clamp Grip C-type



Nickel plated
Application field: For Gripping angled sheet metal

| CODE | L mm | L inch | mm | g | |
|--------------|------|--------|----|-----|---|
| 2511 11 0280 | 280 | 11" | 70 | 700 | 1 |

2512 11 0200

Lock Grip With Flat Jaws



Made from special alloy steel, Nickel plated,
Application field: Gripping sheet metals with 80 mm Flat jaws

| CODE | L mm | L inch | mm | g | |
|--------------|------|--------|----|-----|---|
| 2512 11 0200 | 200 | 8" | 30 | 485 | 1 |

2515 11 0270

Welding Grip



Made from special alloy steel, Nickel plated
Application field : Angled corners and edges

| CODE | L mm | L inch | mm | g | |
|--------------|------|---------|----|-----|---|
| 2515 11 0270 | 270 | 10 5/8" | 50 | 765 | 1 |

2513 11 0280

Grip For Tubes



Made from special alloy steel, Nickel plated,
Application field: Tubes

| CODE | L mm | L inch | mm | g | |
|--------------|------|--------|----|-----|---|
| 2513 11 0280 | 280 | 11" | 50 | 800 | 1 |

13000 005519

Electrician Type Insulated Multi Function Spring Pliers 1000V

⚡ 1000 V
IEC 60900



Special steel, Cutters induction hardened

| CODE | L mm | L inch | g | |
|--------------|------|----------|-----|---|
| 13000 005519 | 215 | 8 15/32" | 245 | 1 |

3020

Combination Pliers



TS 60
TS ISO 5746
DIN ISO 5746



IZELTAS YOUTUBE

Special steel, Cutters induction hardened

| CODE | L mm | L inch | g | □ |
|--------------|------|--------|-----|---|
| 3020 12 2160 | 160 | 6 1/4" | 205 | 5 |
| 3020 12 2180 | 180 | 7 1/8" | 275 | 5 |
| 3020 12 2200 | 200 | 8" | 315 | 5 |

3020

Combination Pliers



TS 60
TS ISO 5746
DIN ISO 5746



Special steel, Cutters induction hardened

| CODE | L mm | L inch | g | □ |
|--------------|------|--------|-----|---|
| 3020 12 3160 | 160 | 6 1/4" | 225 | 5 |
| 3020 12 3180 | 180 | 7 1/8" | 285 | 5 |
| 3020 12 3200 | 200 | 8" | 380 | 5 |

3020

Electrician Type Insulated Combination Pliers 1000V

TS 60
TS ISO 5746
DIN ISO 5746
△ 1000 V
IEC 60900



Special steel, Cutters induction hardened, Chrom plated

| CODE | L mm | L inch | g | □ |
|--------------|------|--------|-----|---|
| 3020 12 6160 | 160 | 6 1/4" | 205 | 5 |
| 3020 12 6180 | 180 | 7 1/8" | 260 | 5 |
| 3020 12 6200 | 200 | 8" | 345 | 5 |

13000 005118

Combination Pliers



TS 60
TS ISO 5746
DIN ISO 5746

Special steel, Cutters induction hardened

| CODE | L mm | L inch | g | □ |
|--------------|------|--------|-----|---|
| 13000 005118 | 180 | 7 1/8" | 275 | 5 |

3030

Combination Pliers Heavy Duty (for piano wire)



Special steel, Cutters induction hardened

| CODE | L mm | L inch | g | □ |
|--------------|------|--------|-----|---|
| 3030 12 2180 | 180 | 7 1/8" | 285 | 5 |
| 3030 12 2200 | 200 | 8" | 380 | 5 |

3220

Long Nose Pliers (Flat)



TS 60 - TS ISO 5745
DIN ISO 5745



İZELTAS YOUTUBE

Special steel, Cutters induction hardened

| CODE | L mm | L inch | g | □ |
|--------------|------|--------|-----|---|
| 3220 13 2140 | 140 | 5 1/2" | 110 | 5 |
| 3220 13 2160 | 160 | 6 1/4" | 135 | 5 |
| 3220 13 2180 | 180 | 7 1/8" | 170 | 5 |
| 3220 13 2200 | 200 | 8" | 205 | 5 |

3220

Insulated Electrician Type
Long Nose Pliers 1000V



TS 60
TS ISO 5745
DIN ISO 5745
△ 1000
IEC 60900



Special steel, Cutters induction hardened, Chrom plated

| CODE | L mm | L inch | g | □ |
|--------------|------|--------|-----|---|
| 3220 13 6140 | 140 | 5 1/2" | 110 | 5 |
| 3220 13 6160 | 160 | 6 1/4" | 140 | 5 |
| 3220 13 6180 | 180 | 7 1/8" | 160 | 5 |
| 3220 13 6200 | 200 | 8" | 170 | 5 |

3220

Long Nose Pliers (Flat)



TS 60 - TS ISO 5745
DIN ISO 5745



Special steel, Cutters induction hardened

| CODE | L mm | L inch | g | □ |
|--------------|------|--------|-----|---|
| 3220 13 3140 | 140 | 5 1/2" | 120 | 5 |
| 3220 13 3160 | 160 | 6 1/4" | 155 | 5 |
| 3220 13 3180 | 180 | 7 1/8" | 185 | 5 |
| 3220 13 3200 | 200 | 8" | 210 | 5 |

13000 005117

Long Nose Pliers (Flat)



TS 60 - TS ISO 5745
DIN ISO 5745



Special steel, Cutters induction hardened

| CODE | L mm | L inch | g | □ |
|--------------|------|--------|-----|---|
| 13000 005117 | 180 | 7 1/8" | 170 | 5 |

3225

Long Nose Pliers (Bent)



TS 60 - TS ISO 5745



Special steel, Cutters induction hardened

| CODE | L mm | L inch | g | □ |
|--------------|------|--------|-----|---|
| 3225 13 2160 | 160 | 6 1/4" | 140 | 5 |
| 3225 13 2180 | 180 | 7 1/8" | 170 | 5 |
| 3225 13 2200 | 200 | 8" | 175 | 5 |

3225

Long Nose Pliers (Bent)



TS 60 - TS ISO 5745



Special steel, Cutters induction hardened

| CODE | L mm | L inch | g | □ |
|--------------|------|--------|-----|---|
| 3225 13 3160 | 160 | 6 1/4" | 150 | 5 |
| 3225 13 3180 | 180 | 7 1/8" | 190 | 5 |
| 3225 13 3200 | 200 | 8" | 195 | 5 |

3020 00 2003

Opak Pliers Set 160mm (3 Pcs)



| CODE | L mm | CONTENTS | □ |
|--------------|------|-------------------------------|---|
| 3020 12 2160 | 160 | Combination Pliers 160mm | 1 |
| 3220 13 2160 | 160 | Long Nose Pliers (Flat) 160mm | 1 |
| 3700 16 2160 | 160 | Side Cutting Pliers 160mm | 1 |

3020 00 1002

Opak Pliers Set, Voltage Tester (Flat) 2 Pcs



| CODE | L mm | CONTENTS | □ |
|--------------|------|-----------------------------|---|
| 3020 12 2160 | 160 | Combination Pliers 160mm | 1 |
| 4550 17 0190 | 190 | Voltage Tester (Flat) 190mm | 1 |

3700

Side Cutting Pliers



TS 60 - TS ISO 5749
DIN ISO 5749



IZELTAS YOUTUBE

Special steel, Cutters induction hardened

| CODE | L mm | L inch | g | □ |
|--------------|------|--------|-----|---|
| 3700 16 2140 | 140 | 5 1/2" | 165 | 5 |
| 3700 16 2160 | 160 | 6 1/4" | 230 | 5 |
| 3700 16 2180 | 180 | 7 1/8" | 240 | 5 |

3700

Insulated Electrician Type Side Cutter 1000V

TS 60
TS ISO 5749
DIN ISO 5749
⚡ 1000 V
IEC 60900



Special steel, Cutters induction hardened, Chrom plated

| CODE | L mm | L inch | g | □ |
|--------------|------|--------|-----|---|
| 3700 16 6140 | 140 | 5 1/2" | 165 | 5 |
| 3700 16 6160 | 160 | 6 1/4" | 215 | 5 |
| 3700 16 6180 | 180 | 7 1/8" | 225 | 5 |

3700

Side Cutting Pliers



TS 60 - TS ISO 5749
DIN ISO 5749



Special steel, Cutters induction hardened

| CODE | L mm | L inch | g | □ |
|--------------|------|--------|-----|---|
| 3700 16 3140 | 140 | 5 1/2" | 190 | 5 |
| 3700 16 3160 | 160 | 6 1/4" | 240 | 5 |
| 3700 16 3180 | 180 | 7 1/8" | 255 | 5 |

13000 005119

Side Cutting Pliers



TS 60 - TS ISO 5749
DIN ISO 5749



Special steel, Cutters induction hardened

| CODE | L mm | L inch | g | □ |
|--------------|------|--------|-----|---|
| 13000 005119 | 160 | 6 1/4" | 230 | 5 |

13000 005133



Black Line Set (5 Pcs)



| CODE | CONTENTS | |
|--------------|-----------------------------------|---|
| 13000 005118 | 180 mm Combination Pliers | 1 |
| 13000 005117 | 180 mm Long Nose Pliers (Flat) | 1 |
| 13000 005119 | 180 mm Side Cutting Pliers | 1 |
| 13000 005116 | 6 x 100 Screwdriver Flat | 1 |
| 13000 005120 | 6 x 100 Screwdriver Phillips | 1 |

Side Cutter For Plastics

TS 60
TS ISO 5749

Side Cutter Heavy Duty (for piano wire)



Special steel, Cutters induction hardened, PVC insulated

Special steel, Cutters induction hardened

| CODE | L mm | L inch | g | □ |
|--------------|------|--------|-----|---|
| 3705 16 5160 | 160 | 6 1/4" | 220 | 5 |

| CODE | L mm | L inch | g | □ |
|--------------|------|--------|-----|---|
| 3730 16 2160 | 160 | 6 1/4" | 200 | 5 |
| 3730 16 2200 | 200 | 8" | 320 | 5 |

3335 00 1004

Circlip Pliers Set (4 Pcs)



330112 0180



3311 12 0170



3321 12 0180



3331 12 0170



İZELTAS YOUTUBE

| CODE | L mm | CONTENTS | □ |
|--------------|------|---------------------------------|---|
| 3301 12 0180 | 180 | Circlip Pliers, External (Flat) | 1 |
| 3311 12 0170 | 170 | Circlip Pliers, External (Bent) | 1 |
| 3321 12 0180 | 180 | Circlip Pliers, Internal (Flat) | 1 |
| 3331 12 0170 | 170 | Circlip Pliers, Internal (Bent) | 1 |

3301

Circlip Pliers, External (Flat)

 TS 60
DIN 5254

Chrom vanadium, Chrom plated, PVC insulated

| CODE | L mm | | g | |
|--------------|------|----------|-----|---|
| 3301 12 0140 | 140 | 10 - 25 | 90 | 5 |
| 3301 12 0180 | 180 | 19 - 60 | 195 | 5 |
| 3301 12 0225 | 225 | 40 - 100 | 235 | 5 |
| 3301 12 0295 | 295 | 85 - 140 | 445 | 5 |

3321

Circlip Pliers Internal (Flat)

 TS 60
DIN 5256

Chrom vanadium, Chrom plated, PVC insulated

| CODE | L mm | | g | |
|--------------|------|----------|-----|---|
| 3321 12 0140 | 140 | 12 - 25 | 100 | 5 |
| 3321 12 0180 | 180 | 19 - 60 | 185 | 5 |
| 3321 12 0225 | 225 | 40 - 100 | 250 | 5 |
| 3321 12 0310 | 310 | 85 - 140 | 445 | 5 |

3311

Circlip Pliers, External (Bent)

 TS 60
DIN 5254

Chrom vanadium, Chrom plated, PVC insulated

| CODE | L mm | | g | |
|--------------|------|----------|-----|---|
| 3311 12 0125 | 125 | 10 - 25 | 105 | 5 |
| 3311 12 0170 | 170 | 19 - 60 | 190 | 5 |
| 3311 12 0210 | 210 | 40 - 100 | 250 | 5 |
| 3311 12 0275 | 275 | 85 - 140 | 445 | 5 |

3331

Circlip Pliers Internal (Bent)

 TS 60
DIN 5256

Chrom vanadium, Chrom plated, PVC insulated

| CODE | L mm | | g | |
|--------------|------|----------|-----|---|
| 3331 12 0130 | 130 | 12 - 25 | 105 | 5 |
| 3331 12 0170 | 170 | 19 - 60 | 185 | 5 |
| 3331 12 0210 | 210 | 40 - 100 | 250 | 5 |
| 3331 12 0290 | 290 | 85 - 140 | 440 | 5 |



3420 12 0220

Hose Clamp Pliers



| CODE | L mm | L inch | g | □ |
|--------------|------|--------|-----|---|
| 3420 12 0220 | 220 | 8 3/4" | 185 | 5 |

3425 12 0220

Hose Clamp Pliers



| CODE | L mm | L inch | g | □ |
|--------------|------|--------|-----|---|
| 3425 12 0220 | 235 | 9 1/4" | 355 | 5 |

3852 24 0225

Revolving Punch Pliers



Size $\emptyset 2$ - $\emptyset 2.5$ - $\emptyset 3$ - $\emptyset 3.5$ - $\emptyset 4$ - $\emptyset 4.5$

| CODE | L mm | L inch | g | □ |
|--------------|------|--------|-----|---|
| 3852 24 0225 | 225 | 9" | 270 | 5 |

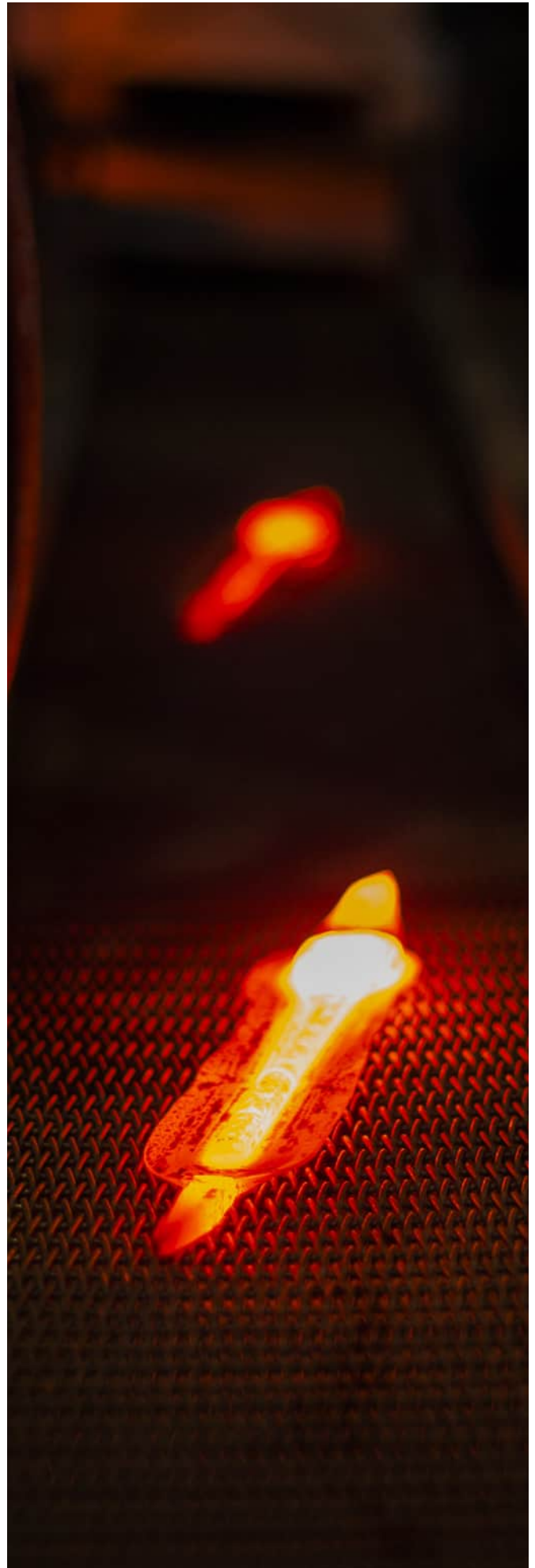

3715 16 0165

Cable Cutter



Special steel, Cutters induction hardened, PVC insulated

| CODE | L mm | L inch |  g |  |
|--------------|---------|-----------|--|--|
| 3715 16 0165 | 165 | 6 1/4 | 210 | 5 |

3715 16 6165

Cable Cutter 1000V

⚡ 1000 V
IEC 60900



Special steel, Cutters induction hardened

| CODE | L mm | L inch |  g |  |
|--------------|---------|-----------|---|---|
| 3715 16 6165 | 165 | 6 1/4 | 230 | 5 |

Cable Cutter, Double Cutter



Saw - Setting Pliers

TSEK



Special steel, Cutters induction hardened, PVC insulated

Special steel, induction hardened, PVC insulated

| CODE | L mm | L inch | g | □ |
|--------------|------|--------|-----|---|
| 3720 16 0220 | 200 | 8" | 265 | 5 |

| CODE | L mm | L inch | g | □ |
|----------------|------|--------|-----|---|
| ★ 3860 26 0180 | 180 | 7 1/8" | 245 | 5 |



★ It is limited by stocks

3550 14 0125

Electronic Diagonal Side Cutting Pliers



Special steel

| CODE | L mm | g |  |
|--------------|---------|----|---|
| 3550 14 0125 | 125 | 76 | 5 |

3553 14 0150

Electronic Flat Nose Pliers



Special steel

| CODE | L mm | g |  |
|--------------|---------|----|---|
| 3553 14 0150 | 150 | 88 | 5 |

3551 14 0125

Electronic End Cutting Pliers



Special steel

| CODE | L mm | g |  |
|--------------|---------|----|---|
| 3551 14 0125 | 125 | 77 | 5 |

3554 14 0150

Electronic Long Nose Pliers



Special steel

| CODE | L mm | g |  |
|--------------|---------|----|---|
| 3554 14 0150 | 150 | 88 | 5 |

3552 14 0125

Electronic Round Nose Pliers



Special steel

| CODE | L mm | g |  |
|--------------|---------|----|---|
| 3552 14 0125 | 125 | 78 | 5 |

3555 14 0150

Electronic Needle Flat Nose Pliers



Special steel

| CODE | L mm | g |  |
|--------------|---------|----|---|
| 3555 14 0150 | 150 | 86 | 5 |

3556 14 0150

Electronic Needle Bent Nose Pliers



Special steel

| CODE | L mm | g | □ |
|--------------|---------|----|---|
| 3556 14 0150 | 150 | 85 | 5 |

3560 00 2104

Electronic Cutter & Pliers Set (4 Pcs)



| CODE | L mm | CONTENTS | □ |
|--------------|---------|---|---|
| 3550 14 0125 | 125 | Electronic Diagonal Side Cutting Pliers | 1 |
| 3551 14 0125 | 125 | Electronic End Cutting Pliers | 1 |
| 3554 14 0150 | 150 | Electronic Long Nose Pliers | 1 |
| 3557 14 0125 | 125 | Electronic Pliers | 1 |

3557 14 0125

Electronic Pliers



Special steel

| CODE | L mm | g | □ |
|--------------|---------|----|---|
| 3557 14 0125 | 125 | 80 | 5 |

3565 00 2104

Electronic Long Nose Pliers Set (4 Pcs)



| CODE | L mm | CONTENTS | □ |
|--------------|---------|------------------------------------|---|
| 3552 14 0125 | 125 | Electronic Round Nose Pliers | 1 |
| 3553 14 0150 | 150 | Electronic Flat Nose Pliers | 1 |
| 3555 14 0150 | 150 | Electronic Needle Nose Pliers | 1 |
| 3556 14 0150 | 150 | Electronic Bent Needle Nose Pliers | 1 |

3800

Carpenter Pincers



TS 60 - TS ISO 9243
DIN ISO 9243



Special steel, Cutters induction hardened, Black finish, PVC insulated

| CODE | L mm | L inch | g | |
|--------------|------|--------|-----|---|
| 3800 15 0160 | 160 | 6 1/4" | 220 | 5 |
| 3800 15 0180 | 180 | 7 1/8" | 295 | 5 |
| 3800 15 0200 | 200 | 8" | 330 | 5 |
| 3800 15 0250 | 250 | 10" | 530 | 5 |

3830

Tower Pincers



TS 60 • TS ISO 9242
DIN ISO 9242



Special steel, Cutters induction hardened, Black finish, PVC insulated

| CODE | L mm | L inch | g | |
|--------------|------|--------|-----|---|
| 3830 15 0225 | 225 | 9" | 345 | 5 |
| 3830 15 0250 | 250 | 10" | 395 | 5 |
| 3830 15 0280 | 280 | 11" | 450 | 5 |

3831 15 0280

Tower Pincers with spring



TS 60 - TS ISO 9242
DIN ISO 9242



Special steel, Cutters induction hardened, Black finish, PVC insulated

| CODE | L mm | L inch | g | |
|--------------|------|--------|-----|---|
| 3831 15 0280 | 280 | 11" | 455 | 5 |

3835 15 0280

Heavy Tower Pincers

TS 60 - TS ISO 9242
DIN ISO 9242



İZELTAS YOUTUBE

Special steel, Cutters induction hardened, Black finish, PVC insulated

| CODE | L mm | L inch | g | |
|--------------|------|--------|-----|---|
| 3835 15 0280 | 280 | 11" | 400 | 5 |

3850 12 0200

Shoemaker Pliers



Special steel, Induction hardened, Black finish

| CODE | L mm | L inch | g | |
|--------------|------|--------|-----|---|
| 3850 12 0200 | 200 | 8" | 360 | 5 |



1000V INSULATED TOOLS



VDE CERTIFIED PRODUCTS

- » As the leading brand in hand tools sector, CDE certified products of İZELTAŞ make a difference in electrical sector.
- These products assure the user with their handles specially designed to provide isolation up to 1000 V.
 - They provide safe use in areas with electrical current.
 - The products are certified by German VDE institution, being subjected to various tests particularly including fire resistance, 1000 V electrical resistance and handle detachment tests in hot and cold air conditions.
 - They provide ease of grip and use with an ergonomic design.



Important points for use

- Only specially trained and expert personnel should engage in work in areas with electrical current.
- Before each use VDE certified products and their isolation materials should be checked against damage.
- VDE certified products should not be used outside their purpose or in combination.
- Protective equipment should also be used to protect personnel in addition to VDE certified products.



Our VDE certified products are controlled in accord with the applicable international standards and then are subjected to five different tests:

» 1- Voltage Test: No residual current or electrical arc should be seen on the isolated hand tool subjected to 10,000 V for 3 minutes.

3- Durability Test: Hand tools left in +70 °C for 1 week are subjected to handle detachment test with a load of 50 kg. The handle should not detach.

5- Fire Test: The tool is subjected to high intensity flames for 20 seconds. After contact with the flame is ended the isolation material should not continue burning.

2- Cold Shock Test: Hand tools left in -24 °C for 2 hours (shocked) are subjected to impacts with a 600 gr weight dropped from a height of 60-80 cm. No breakage or cracking should be seen on the isolation material.

4- Perviousness Test: Pointed tips under 2 kg load are used to apply 5000 V electrical current for 3 minutes. There should be no residual current or electrical arc.



ELECTRICIAN TYPE INSULATED COMBINATION PLIER 1000V



Toothed surface for strong grip

Heat-treated and induction hardened cutting edges for long lifetime

High corrosion resistance with chrome over nickel plating

High carbon forged steel for improved durability

VDE/GS certified, insulated for 1000V usage. Two component ergonomic handle with high strength and soft grip plastic



IZELTAS YOUTUBE

0255

Single Ended Open Jaw Wrench
Super Insulated (mm)

⚡ 1000 V
IEC 60900



Chrom plated, Triple PVC insulated

| CODE | ⊘ mm | L mm | ⚖ g | 📏 |
|--------------|------|------|-----|----|
| 0255 01 0010 | 10 | 110 | 40 | 10 |
| 0255 01 0011 | 11 | 120 | 45 | 10 |
| 0255 01 0012 | 12 | 130 | 50 | 10 |
| 0255 01 0013 | 13 | 140 | 60 | 10 |
| 0255 01 0014 | 14 | 155 | 75 | 10 |
| 0255 01 0017 | 17 | 170 | 100 | 10 |
| 0255 01 0019 | 19 | 185 | 150 | 10 |
| 0255 01 0022 | 22 | 200 | 200 | 10 |
| 0255 01 0024 | 24 | 220 | 280 | 10 |

0435

Single Ended Ring Wrench
Super Insulated (mm)

⚡ 1000 V
IEC 60900



Chrom plated, Triple PVC insulated

| CODE | ⊘ mm | L mm | ⚖ g | 📏 |
|--------------|------|------|-----|----|
| 0435 03 0010 | 10 | 170 | 100 | 10 |
| 0435 03 0011 | 11 | 175 | 110 | 10 |
| 0435 03 0012 | 12 | 180 | 130 | 10 |
| 0435 03 0013 | 13 | 185 | 150 | 10 |
| 0435 03 0014 | 14 | 190 | 180 | 10 |
| 0435 03 0017 | 17 | 205 | 220 | 10 |
| 0435 03 0019 | 19 | 220 | 270 | 10 |
| 0435 03 0022 | 22 | 245 | 310 | 10 |
| 0435 03 0024 | 24 | 270 | 420 | 10 |

0600 01 0010

Insulated Electrician Type Adjustable
Wrench 1000V

TS ISO 6787
⚡ 1000 V / IEC 60900



Chrom plated, Triple PVC insulated

| CODE | L mm | L inch | a mm | ⚖ g | 📏 |
|--------------|------|--------|------|-----|---|
| 0600 01 0010 | 260 | 10" | 28 | 440 | 5 |

Socket Wrench 6 Points 1000V (mm)

TS ISO 2725-1
DIN 3124

⚡ 1000 V
IEC 60900



1/2"

Chrom plated

| CODE | ⊘ mm | ∅ D1 mm | ∅ D2 mm | L mm | L1 mm | ⚖ g | 📏 |
|--------------|------|---------|---------|------|-------|-----|---|
| 13000 005148 | 10 | 19.5 | 27 | 40 | 7 | 55 | 1 |
| 13000 005149 | 11 | 20.7 | 27 | 40 | 7 | 55 | 1 |
| 13000 005150 | 12 | 22 | 27 | 40 | 8 | 55 | 1 |
| 13000 005151 | 13 | 23.2 | 27 | 40 | 8 | 60 | 1 |
| 13000 005152 | 14 | 24.5 | 27 | 40 | 9 | 60 | 1 |
| 13000 005153 | 15 | 25.7 | 27 | 40 | 10 | 65 | 1 |
| 13000 005154 | 16 | 27 | 27 | 40 | 11 | 65 | 1 |
| 13000 005155 | 17 | 28.2 | 27 | 40 | 11 | 65 | 1 |
| 13000 005156 | 19 | 30.7 | 27 | 42 | 11 | 70 | 1 |
| 13000 005157 | 22 | 34.5 | 27 | 44 | 12 | 70 | 1 |
| 13000 005158 | 24 | 37 | 27 | 46 | 13 | 75 | 1 |
| 13000 005159 | 27 | 40.7 | 27 | 48 | 13 | 75 | 1 |

13000 005277

Ratchet Handle 1000V (36 Teeth)

⚡ 1000 V
IEC 60900



1/2"



| CODE | L mm | ⚖ g | 📏 |
|--------------|------|-----|---|
| 13000 005277 | 275 | 540 | 1 |

Extension Bar 1000V

⚡ 1000 V
IEC 60900



1/2"

Chrom plated

| CODE | L mm | g | □ |
|--------------|------|-----|---|
| 13000 005262 | 75 | 140 | 1 |
| 13000 005263 | 125 | 215 | 1 |
| 13000 005264 | 250 | 420 | 1 |

13000 005541

1000V Sliding T - Handle

⚡ 1000 V
IEC 60900



1/2"

Chrom plated

| CODE | L mm | g | □ |
|--------------|------|-----|---|
| 13000 005541 | 250 | 355 | 5 |

2400 11 6240

Insulated Type Waterpump Pliers Universal 1000V

TS 60
TS ISO 8976
⚡ 1000 V
IEC 60900



Chrom plated, Two component handle

| CODE | L mm | L inch | mm | g | □ |
|--------------|------|--------|----|-----|---|
| 2400 11 6240 | 240 | 9 1/2" | 35 | 370 | 5 |

13000 005519

Electrician Type Insulated Multi Function Spring Pliers 1000V

⚡ 1000 V
IEC 60900



Chrom plated

| CODE | L mm | L inch | g | □ |
|--------------|------|----------|-----|---|
| 13000 005519 | 215 | 8 15/32" | 245 | 1 |

3715 16 6165

Cable Cutter 1000V

⚡ 1000 V
IEC 60900



Special steel, Cutters induction hardened

| CODE | L mm | L inch | g |
|--------------|------|--------|-----|
| 3715 16 6165 | 165 | 6 1/4 | 150 |

03753 50 026

Mechanical Cable Stripper



| CODE | SIZE | g | □ |
|--------------|---------|-----|---|
| 03753 50 026 | 0.2 / 6 | 105 | 5 |

3020

Insulated Electrician Type Combination Pliers 1000V



TS 60
TS ISO 5746
DIN ISO 5746
⚡ 1000 V
IEC 60900



Special steel, Cutters induction hardened, Chrom plated

| CODE | L mm | L inch | g | □ |
|--------------|------|--------|-----|---|
| 3020 12 6160 | 160 | 6 1/4" | 205 | 5 |
| 3020 12 6180 | 180 | 7 1/8" | 260 | 5 |
| 3020 12 6200 | 200 | 8" | 345 | 5 |

3700

Insulated Electrician Type Side Cutter 1000V

TS 60
TS ISO 5749
DIN ISO 5749
⚡ 1000 V
IEC 60900



Special steel, Cutters induction hardened, Chrom plated

| CODE | L mm | L inch | g | □ |
|--------------|------|--------|-----|---|
| 3700 16 6140 | 140 | 5 1/2" | 165 | 5 |
| 3700 16 6160 | 160 | 6 1/4" | 215 | 5 |
| 3700 16 6180 | 180 | 7 1/8" | 225 | 5 |

3220

Insulated Electrician Type Nose Pliers 1000V



TS 60
TS ISO 5745
DIN ISO 5745
⚡ 1000 V
IEC 60900



Special steel, Cutters induction hardened, Chrom plated

| CODE | L mm | L inch | g | □ |
|--------------|------|--------|-----|---|
| 3220 13 6140 | 140 | 5 1/2" | 110 | 5 |
| 3220 13 6160 | 160 | 6 1/4" | 140 | 5 |
| 3220 13 6180 | 180 | 7 1/8" | 160 | 5 |
| 3220 13 6200 | 200 | 8" | 170 | 5 |

3020 00 6003

1000V Insulated Tool Set (3 Pcs)



| CODE | CONTENTS | □ |
|--------------|--|---|
| 3020 12 6160 | Insulated Electrician Type Combination Pliers | 1 |
| 3220 13 6160 | Insulated Electrician Type Nose Pliers 160 mm 1000V | 1 |
| 3700 16 6160 | Insulated Electrician Type Side Cutter | 1 |

4140

Insulated Electrician Type Flat Screwdriver 1000V



TS ISO 2380-1
DIN ISO 2380-1
⚡ 1000 V
IEC 60900

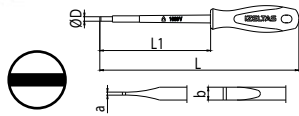

Black finish

| CODE | øDxL1 mm | ⊖ | | L mm | g | □ |
|--------------|-------------|---------|---------|---------|----|----|
| | | a mm | b mm | | | |
| 4140 17 2575 | 2.5x75 | 0.4 | 2.5 | 150 | 25 | 10 |
| 4140 17 4100 | 4x100 | 0.8 | 4 | 185 | 40 | 10 |
| 4140 17 5512 | 5.5x125 | 1 | 5.5 | 220 | 70 | 10 |
| 4140 17 6515 | 6.5x150 | 1.2 | 6.5 | 245 | 90 | 10 |

4773

Nut Spinner, Electrician Blade Insulated 1000V

⚡ 1000 V
IEC 60900

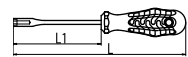

Two component handle

| CODE | ⊖ mm | L mm | L1 mm | g | □ |
|--------------|---------|---------|----------|-----|----|
| 4773 19 0040 | 4 | 220 | 125 | 90 | 10 |
| 4773 19 0050 | 5 | 220 | 125 | 90 | 10 |
| 4773 19 0055 | 5.5 | 220 | 125 | 90 | 10 |
| 4773 19 0060 | 6 | 220 | 125 | 90 | 10 |
| 4773 19 0070 | 7 | 230 | 125 | 110 | 10 |
| 4773 19 0080 | 8 | 230 | 125 | 120 | 10 |
| 4773 19 0090 | 9 | 230 | 125 | 125 | 10 |
| 4773 19 0100 | 10 | 230 | 125 | 125 | 10 |
| 4773 19 0110 | 11 | 230 | 125 | 140 | 10 |
| 4773 19 0120 | 12 | 230 | 125 | 145 | 10 |
| 4773 19 0130 | 13 | 230 | 125 | 150 | 10 |
| 4773 19 0140 | 14 | 230 | 125 | 150 | 10 |

4145

Insulated Electrician Type Phillips Screwdriver 1000V



TS 59-5 ISO 8764
DIN ISO 8764
⚡ 1000 V
IEC 60900

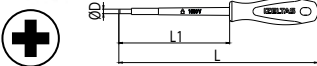

Chrom vanadium, Black finish

| CODE | øDxL1 mm | + | L mm | g | □ |
|--------------|-------------|-----|---------|----|----|
| 4145 18 0360 | 3x60 | Ph0 | 135 | 25 | 10 |
| 4145 18 4580 | 4.5x80 | Ph1 | 165 | 45 | 10 |
| 4145 18 6100 | 6x100 | Ph2 | 195 | 70 | 10 |

4140 00 9106

Insulated Electrician Set (6 Pcs) Screwdriver 1000V



| CODE | CONTENTS | g | □ |
|--------------|---------------------|-----|---|
| 4140 00 9106 | ⊖ 2.5x75 - 4x100 | 340 | 6 |
| | ⊖ 5.5x125 - 6.5x150 | | |
| | Flat | | |
| | ⊕ 4.5x80 - 6x100 | | |
| | Phillips | | |

4773 00 8108

Nut Spinner, Electrician Blade Insulated Set (8 Pcs) 1000V



| CODE | CONTENTS | g | □ |
|--------------|-----------------------------------|------|---|
| 4773 00 8108 | 6 - 7 - 8 - 9 - 10 - 11 - 12 - 13 | 2225 | 8 |

4783 19 6120

Screwdriver, Magnetic Bit Holder Insulated 1000V

⚡ 1000 V
IEC 60900

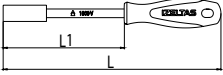

Chrome vanadium, Two component handle

| CODE | mm | L mm | L1 mm | g | |
|--------------|-----|------|-------|-----|----|
| 4783 19 6120 | 6.3 | 230 | 120 | 115 | 10 |

8795 00 6005

1000V Insulated Tool Set (5 Pcs)



IZELTAS YOUTUBE

| CODE | CONTENTS | |
|--------------|---|---|
| 3020 12 6180 | Insulated Electrician Type Combination Pliers 1000V | 1 |
| 3220 13 6200 | Insulated Electrician Type Nose Pliers | 1 |
| 3700 16 6160 | Insulated Electrician Type Nose | 1 |
| 4140 17 5512 | Insulated Electrician Type Flat Screwdriver 1000V | 1 |
| 4145 18 6100 | Insulated Electrician Type Phillips Screwdriver 1000V | 1 |

8440 00 1023

Plastic Tool Box for Electrician 19" (23 Pcs)



| CODE | CONTENTS | |
|--------------|--|---|
| 8440 33 1019 | Plastic Tool Box | 1 |
| 3700 16 6160 | Insulated Electrician Type Side Cutter 1000V | 1 |
| 3020 12 6180 | Insulated Electrician Type Combination Pliers 1000V | 1 |
| 3220 13 6160 | Insulated Electrician Type Nose Pliers 1000V | 1 |
| 4773 19 0100 | 10mm Nut Spinner, Electrician Blade Insulated 1000V | 1 |
| 4773 19 0130 | 13mm Nut Spinner, Electrician Blade Insulated 1000V | 1 |
| 3715 16 6165 | Cable Cutter 1000V | 1 |
| 4520 18 0360 | Electronic Screwdriver, Phillips | 1 |
| 4520 18 0480 | Electronic Screwdriver, Phillips | 1 |
| 4500 17 0380 | Electronic Screwdriver, Flat | 1 |
| 4500 17 0480 | Electronic Screwdriver, Flat | 1 |
| 4140 17 4100 | Insulated Electrician Type Flat Screwdriver 1000V | 1 |
| 4145 18 4580 | Insulated Electrician Type Phillips Screwdriver 1000V | 1 |
| 4145 18 6100 | Insulated Electrician Type Phillips Screwdriver 1000V | 1 |
| 4550 17 0190 | Voltage Tester Flat | 1 |
| 4560 18 0190 | Voltage Tester Phillips | 1 |
| 4783 19 6120 | Screwdriver, Magnetic Bit Holder Insulated 1000V | 1 |
| 4800 00 8106 | Bit Set 6 Pcs 25 mm | 6 |



SCREWDRIVERS AND HEX KEY WRENCHES

Screwdrivers

Testers

Bits

Hex Key Wrenches



VOLTAGE TESTER

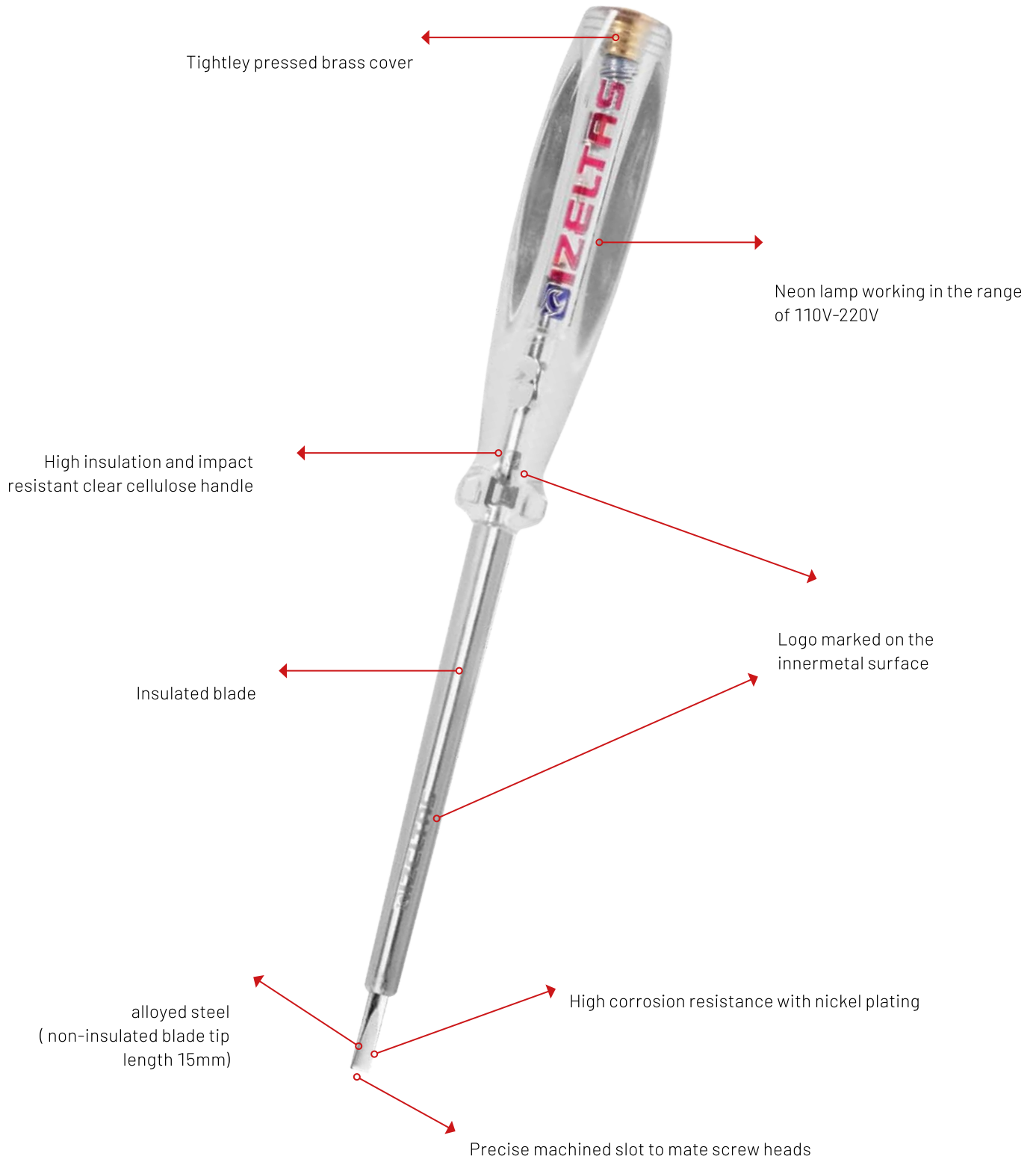

4550

Voltage Tester (Flat)

TS 13108

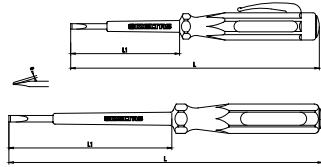

Nickel plated

| CODE | L mm | ⊖ | | L1 mm | g | □ |
|--------------|---------|---------|---------|----------|----|----|
| | | a mm | b mm | | | |
| 4550 17 0135 | 135 | 0.5 | 3 | 60 | 20 | 10 |
| 4550 17 0190 | 190 | 0.8 | 4 | 100 | 40 | 10 |

4560

Voltage Tester (Phillips)

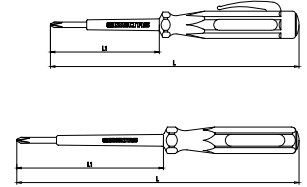

, Nickel plated

| CODE | L mm | L1 mm | ⊕ | g | □ |
|--------------|---------|----------|-----|----|----|
| | | | | | |
| 4560 18 0190 | 190 | 100 | Ph0 | 40 | 10 |

4555 17 0165

Voltage Tester Master (Flat)

TS 13108

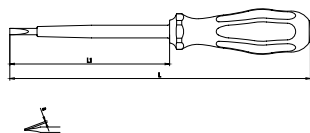

Nickel plated

| CODE | L mm | ⊖ | | L1 mm | g | □ |
|----------------|---------|---------|---------|----------|----|----|
| | | a mm | b mm | | | |
| ★ 4555 17 0165 | 165 | 0.5 | 3.5 | 88 | 40 | 10 |

4565 17 0135

Car Voltage Tester

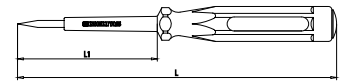

Chrom plated

Tool is used to control 6-24V electrical wiring in all cars and heavy duty vehicles. With its point tip, wires and sockets are not required to be disassembled.

| CODE | L mm | L1 mm | ⊙ | Kablo L (m) | g | □ |
|------|---------|----------|---|-------------------|---|---|
| | | | | | | |

★ It is Limited by Stocks.

Screwdriver, Kraft, Flat



TS ISO 2380 - 1
DIN ISO 2380-1

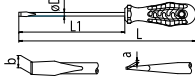

Chrom plated and black tip, Cellulose acetate handle

| CODE | øDxL1 mm | ⊖ | | L mm | g | □ |
|--------------|-------------|---------|---------|---------|-----|----|
| | | a mm | b mm | | | |
| 4100 17 0340 | 3x40 | 0.5 | 3 | 105 | 20 | 10 |
| 4100 17 0380 | 3x80 | 0.5 | 3 | 155 | 35 | 10 |
| 4100 17 0480 | 4x80 | 0.8 | 4 | 165 | 50 | 10 |
| 4100 17 4100 | 4x100 | 0.8 | 4 | 185 | 50 | 10 |
| 4100 17 0580 | 5x80 | 1.0 | 5.5 | 175 | 70 | 10 |
| 4100 17 5100 | 5x100 | 1.0 | 5.5 | 195 | 75 | 10 |
| 4100 17 5125 | 5x125 | 1.0 | 5.5 | 220 | 80 | 10 |
| 4100 17 5150 | 5x150 | 1.0 | 5.5 | 245 | 80 | 10 |
| 4100 17 6100 | 6x100 | 1.2 | 6.5 | 195 | 85 | 10 |
| 4100 17 6125 | 6x125 | 1.2 | 6.5 | 220 | 90 | 10 |
| 4100 17 6150 | 6x150 | 1.2 | 6.5 | 245 | 95 | 10 |
| 4100 17 6175 | 6x175 | 1.2 | 6.5 | 270 | 100 | 10 |
| 4100 17 7125 | 7x125 | 1.2 | 8 | 230 | 120 | 10 |
| 4100 17 7150 | 7x150 | 1.2 | 8 | 255 | 130 | 10 |
| 4100 17 7175 | 7x175 | 1.2 | 8 | 280 | 135 | 10 |
| 4100 17 8150 | 8x150 | 1.6 | 10 | 255 | 145 | 10 |
| 4100 17 8175 | 8x175 | 1.6 | 10 | 280 | 150 | 10 |
| 4100 17 8200 | 8x200 | 1.6 | 10 | 305 | 160 | 10 |
| 4100 17 9200 | 9x200 | 2.0 | 12 | 305 | 190 | 10 |
| 4100 17 1125 | 11x250 | 2.5 | 14 | 365 | 305 | 10 |



Screwdriver, Flat, Kraft Set (8 Pcs)



| CODE | CONTENTS | g | □ |
|--------------|---|-----|---|
| 4100 00 8108 | 3x80 - 4x80 - 4x100 5x100 - 5x125 - 6x100 6x125 - 6x150 Flat | 550 | 8 |

Screwdriver, Kraft, Flat, Long

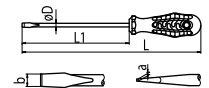

Chrom plated and black tip, Cellulose acetate handle

| CODE | øDxL1 mm | ⊖ | | L mm | g | □ |
|--------------|-------------|---------|---------|---------|-----|----|
| | | a mm | b mm | | | |
| 4100 17 4300 | 4x300 | 0.8 | 4 | 385 | 70 | 10 |
| 4100 17 5250 | 5x250 | 1.0 | 5.5 | 345 | 95 | 10 |
| 4100 17 5350 | 5x350 | 1.0 | 5.5 | 445 | 115 | 10 |
| 4100 17 6350 | 6x350 | 1.2 | 6.5 | 445 | 125 | 10 |

4120

Screwdriver, Kraft, Phillips



TS 59 - 5 ISO 8764-1
DIN ISO 8764-1

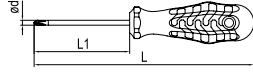

Chrom plated and black tip, Cellulose acetate handle

| CODE | ødxL1 mm | + | L mm | g | □ |
|--------------|-------------|-----|---------|-----|----|
| 4120 18 0360 | 3x60 | Ph0 | 135 | 30 | 10 |
| 4120 18 4580 | 4.5x80 | Ph1 | 165 | 55 | 10 |
| 4120 18 5100 | 4.5x100 | Ph1 | 185 | 55 | 10 |
| 4120 18 5150 | 4.5x150 | Ph1 | 235 | 60 | 10 |
| 4120 18 6100 | 6x100 | Ph2 | 195 | 85 | 10 |
| 4120 18 6150 | 6x150 | Ph2 | 245 | 95 | 10 |
| 4120 18 6200 | 6x200 | Ph2 | 295 | 105 | 10 |
| 4120 18 8150 | 8x150 | Ph3 | 255 | 150 | 10 |
| 4120 18 1200 | 10x200 | Ph4 | 315 | 240 | 10 |

4120 00 8106

Screwdriver, Kraft, Phillips, Set (6 Pcs)



| CODE | CONTENTS | g | □ |
|--------------|---|-----|---|
| 4120 00 8106 | 3x60 - 4.5x80 4.5x100 - 4.5x150 6x100 - 6x150 Phillips | 380 | 6 |

4120

Screwdriver, Kraft, Phillips, Long

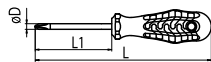

Chrom plated and black tip, Cellulose acetate handle

| CODE | øDxL1 mm | + | L mm | g | □ |
|--------------|-------------|-----|---------|-----|----|
| 4120 18 5300 | 4.5x300 | Ph1 | 385 | 80 | 10 |
| 4120 18 6300 | 6x300 | Ph2 | 395 | 125 | 10 |

4100 00 8107

Screwdriver Set, Kraft (7 Pcs)



| CODE | CONTENTS | g | □ |
|--------------|--|-----|---|
| 4100 00 8107 | 3x80 - 4x80 - 4x100 5x125 - 6x150 Flat 4.5x80 - 6x100 Phillips | 445 | 7 |

4110

Screwdriver, Kraft, Stubby, Flat

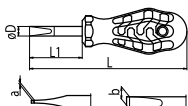

Chrom vanadium, Chrom plated and black tip, Cellulose acetate handle

| CODE | σDxL1 mm | ⊖ | | L mm | g | □ |
|--------------|-------------|---------|---------|---------|----|---|
| | | a mm | b mm | | | |
| 4110 17 5525 | 5.5x25 | 1 | 5.5 | 70 | 30 | 5 |
| 4110 17 5540 | 5.5x40 | 1 | 5.5 | 105 | 45 | 5 |
| 4110 17 6525 | 6.5x25 | 1.2 | 6.5 | 70 | 35 | 5 |
| 4110 17 6540 | 6.5x40 | 1.2 | 6.5 | 105 | 50 | 5 |

4130

Screwdriver, Kraft, Stubby, Phillips

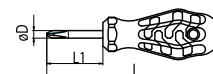

Chrom vanadium, Chrom plated and black tip, Cellulose acetate handle

| CODE | σDxL1 mm | ⊕ | L mm | g | □ |
|--------------|-------------|-----|---------|----|---|
| | | | | | |
| 4130 18 4540 | 4.5x40 | Ph1 | 105 | 40 | 5 |
| 4130 18 0625 | 6x25 | Ph2 | 70 | 30 | 5 |
| 4130 18 0640 | 6x40 | Ph2 | 105 | 50 | 5 |

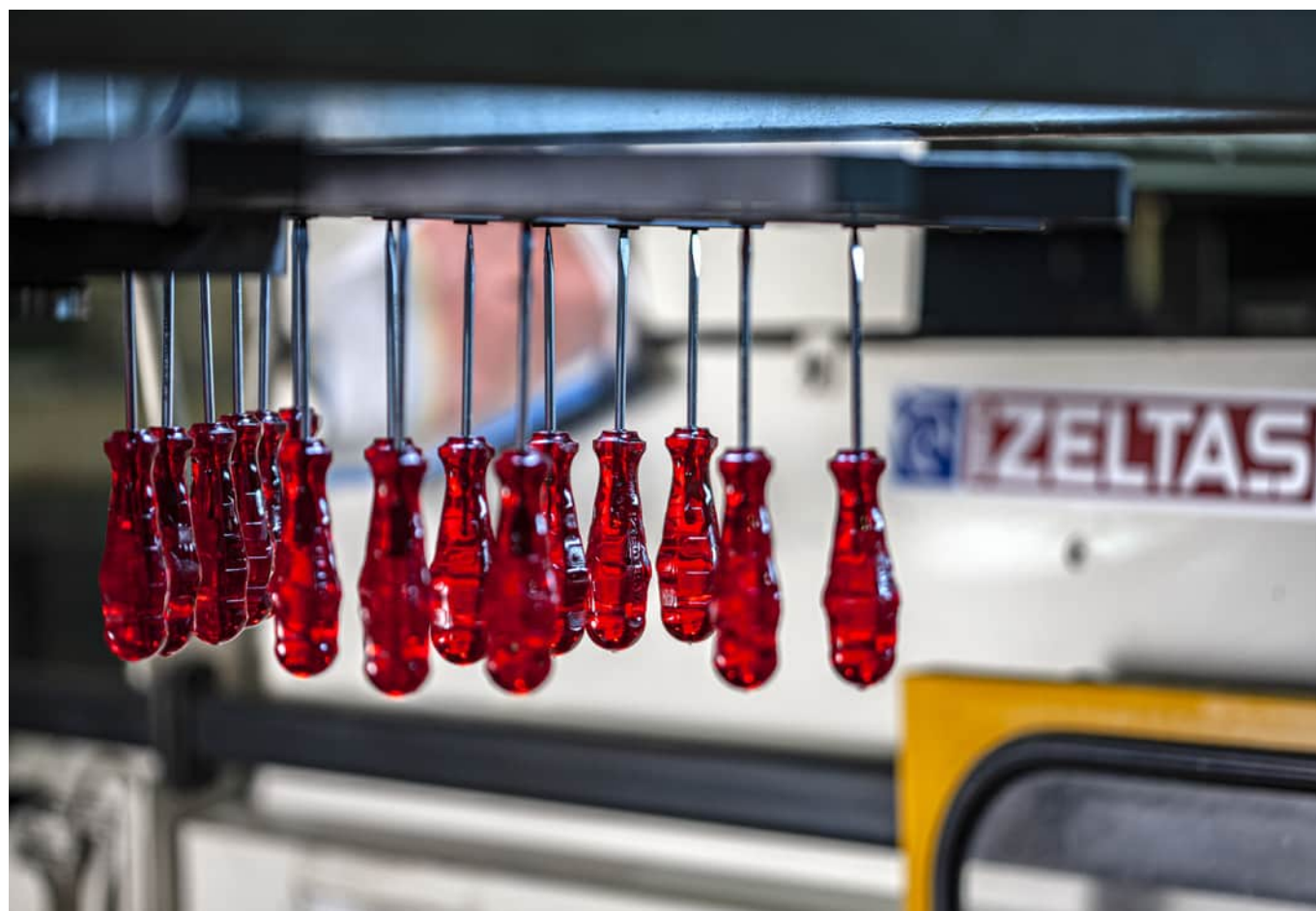

4140

Insulated Electrician Type Flat
Screwdriver 1000V

TS ISO 2380-1
DIN ISO 2380-1
△ 1000 V
IEC 60900

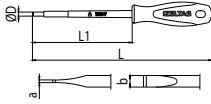

Chrom vanadium, Black finish

| CODE | σDxL1 mm | ⊖ | | L mm | g | □ |
|--------------|-------------|---------|---------|---------|----|----|
| | | a mm | b mm | | | |
| 4140 17 2575 | 2.5x75 | 0.4 | 2.5 | 150 | 25 | 10 |
| 4140 17 4100 | 4x100 | 0.8 | 4 | 185 | 40 | 10 |
| 4140 17 5512 | 5.5x125 | 1 | 5.5 | 220 | 70 | 10 |
| 4140 17 6515 | 6.5x150 | 1.2 | 6.5 | 245 | 90 | 10 |

4145

Insulated Electrician Type Phillips
Screwdriver 1000V

TS 59-5ISO 8764
DIN ISO 8764
△ 1000 V
IEC 60900

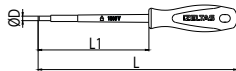

Chrom vanadium, Black finish

| CODE | σDxL1 mm | + | L mm | g | □ |
|--------------|-------------|-----|---------|----|----|
| | | | | | |
| 4145 18 4580 | 4.5x80 | Ph1 | 165 | 45 | 10 |
| 4145 18 6100 | 6x100 | Ph2 | 195 | 70 | 10 |

4140 00 9106

Insulated Electrician Set (6 Pcs) Screwdriver 1000V

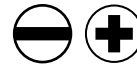

| CODE | CONTENTS | g | □ |
|--------------|---------------------|-----|---|
| 4140 00 9106 | 2.5x75 - 4x100 | 340 | 6 |
| | ⊖ 5.5x125 - 6.5x150 | | |
| | ⊕ 4.5x80 - 6x100 | | |
| | Phillips | | |

13000 005116

Screwdriver, Flat



TS ISO 2380-1
DIN ISO 2380-1

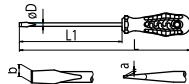

Chrome vanadium, Chrom plated and black tip, PP handle

| CODE | σDxL1 mm | ⊖ | | L mm | g | □ |
|--------------|-------------|---------|---------|---------|----|----|
| | | a mm | b mm | | | |
| 13000 005116 | 6x100 | 1.2 | 6.5 | 195 | 65 | 10 |

13000 005120

Screwdriver, Phillips



TS 59 - 5 ISO 8764-1
DIN ISO 8764

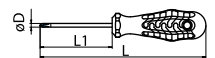

Chrome vanadium, Chrom plated and black tip, PP handle

| CODE | σdxL1 mm | + | L mm | g | □ |
|--------------|-------------|-----|---------|----|----|
| 13000 005120 | 6x100 | Ph2 | 195 | 70 | 10 |

4300

Screwdriver, Opak, Flat



TS ISO 2380-1
DIN ISO 2380-1



Chrome vanadium, Chrom plated and black tip, PP handle

| CODE | øDxL1 mm | ⊖ | | L mm | g | □ |
|--------------|-------------|---------|---------|---------|-----|----|
| | | a mm | b mm | | | |
| 4300 17 0380 | 3x80 | 0.5 | 3 | 155 | 25 | 10 |
| 4300 17 0480 | 4x80 | 0.8 | 4 | 165 | 35 | 10 |
| 4300 17 4100 | 4x100 | 0.8 | 4 | 185 | 40 | 10 |
| 4300 17 5100 | 5x100 | 1.0 | 5.5 | 195 | 60 | 10 |
| 4300 17 5125 | 5x125 | 1.0 | 5.5 | 220 | 60 | 10 |
| 4300 17 6100 | 6x100 | 1.2 | 6.5 | 195 | 65 | 10 |
| 4300 17 6125 | 6x125 | 1.2 | 6.5 | 220 | 70 | 10 |
| 4300 17 6150 | 6x150 | 1.2 | 6.5 | 245 | 80 | 10 |
| 4300 17 7125 | 7x125 | 1.2 | 8 | 230 | 95 | 10 |
| 4300 17 7150 | 7x150 | 1.2 | 8 | 255 | 105 | 10 |
| 4300 17 8175 | 8x175 | 1.6 | 10 | 280 | 130 | 10 |
| 4300 17 9200 | 9x200 | 2.0 | 12 | 305 | 165 | 10 |

4320

Screwdriver, Opak, Phillips



TS 59 - 5 ISO 8764-1
DIN ISO 8764



Chrome vanadium, Chrom plated and black tip, PP handle

| CODE | øDxL1 mm | + | L mm | g | □ |
|--------------|-------------|-----|---------|-----|----|
| 4320 18 0360 | 3x60 | Ph0 | 135 | 25 | 10 |
| 4320 18 4580 | 4.5x80 | Ph1 | 165 | 40 | 10 |
| 4320 18 6100 | 6x100 | Ph2 | 195 | 70 | 10 |
| 4320 18 8150 | 8x150 | Ph3 | 255 | 140 | 10 |

4300 00 8107

Screwdriver Set, Opak (7 Pcs)

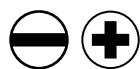

| CODE | CONTENTS | g | □ |
|--------------|------------------------------------|-----|---|
| 4300 00 8107 | 3x80 - 4x80 - 4x100 | 520 | 7 |
| | 5x125 - 6x150 | | |
| | Flat 4.5x80 - 6x100 Phillips | | |

4325

Screwdriver, Opak, Pozidriv

TS 59 - 5 ISO 8764-1
DIN ISO 8764



Chrome vanadium, Chrom plated and black tip, PP handle

| CODE | øDxL1 mm | + | L mm | g | □ |
|--------------|-------------|-----|---------|-----|----|
| 4325 18 0360 | 3x60 | Pz0 | 135 | 25 | 10 |
| 4325 18 4580 | 4.5x80 | Pz1 | 165 | 40 | 10 |
| 4325 18 6100 | 6x100 | Pz2 | 195 | 70 | 10 |
| 4325 18 8150 | 8x150 | Pz3 | 255 | 140 | 10 |

4240 17 0680

Screwdriver - Reversible

TSEK

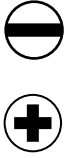

Chrom vanadium, Chrom plated, Cellulose acetate handle

| CODE | øDxL1 mm | ⊖ axb mm | ⊕ | L mm | g | □ |
|--------------|-------------|----------------|-----|---------|----|----|
| 4240 17 0680 | 6x80 | 1.2x6 | Ph2 | 175 | 80 | 10 |

4240 00 7102

Screwdriver Set - Reversible

TSEK



| CODE | øDxL1 mm | ⊖ axb mm | ⊕ | L mm | g | □ |
|--------------|-------------|----------------|-----|---------|-----|---|
| 4240 00 7102 | 6x80 | 1.2x6 | Ph2 | 175 | 105 | 1 |
| | 4.5x80 | 0.65x4.5 | Ph1 | | | |

4500

Electronic Screwdriver, Flat



Chrome vanadium, Chrom plated and black tip, PP handle

| CODE | øDxL1 mm | ⊖ | | L mm | g | □ |
|--------------|-------------|---------|---------|---------|----|----|
| | | a mm | b mm | | | |
| 4500 17 2560 | 2.5x60 | 0.4 | 2.5 | 140 | 15 | 10 |
| 4500 17 2580 | 2.5x80 | 0.4 | 2.5 | 160 | 15 | 10 |
| 4500 17 0380 | 3x80 | 0.5 | 3 | 160 | 15 | 10 |
| 4500 17 3100 | 3x100 | 0.5 | 3 | 180 | 20 | 10 |
| 4500 17 3125 | 3x125 | 0.5 | 3 | 205 | 20 | 10 |
| 4500 17 3510 | 3.5x100 | 0.6 | 3.5 | 180 | 20 | 10 |
| 4500 17 0480 | 4x80 | 0.8 | 4 | 160 | 20 | 10 |
| 4500 17 4100 | 4x100 | 0.8 | 4 | 180 | 20 | 10 |
| 4500 17 4125 | 4x125 | 0.8 | 4 | 205 | 25 | 10 |
| 4500 17 4150 | 4x150 | 0.8 | 4 | 230 | 25 | 10 |

4520

Electronic Screwdriver, Phillips



Chrome vanadium, Chrom plated and black tip, PP handle

| CODE | øDxL1 mm | ⊕ | L mm | g | □ |
|--------------|-------------|-----|---------|----|----|
| 4520 18 0360 | 3x60 | Ph0 | 140 | 15 | 10 |
| 4520 18 0480 | 4x80 | Ph0 | 160 | 20 | 10 |
| 4520 18 4150 | 4x150 | Ph0 | 230 | 25 | 10 |

4500 00 8106

Electronic Screwdriver Set (6 Pcs)



| CODE | CONTENTS | g | □ |
|--------------|--|-----|---|
| 4500 00 8106 | ⊖ 3x80 - 3x100 3x125 - 4x150 Flat | 115 | 6 |
| | ⊕ 3x60 - 4x80 Phillips | | |

Electronic Screwdriver, Torx®

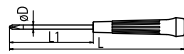

Chrome vanadium, Chrom plated and black tip, PP handle

| CODE | ØDxL1 mm | ★ | L mm | g | □ |
|--------------|----------|-----|------|----|----|
| 4530 17 0560 | 2.5x60 | T5 | 145 | 15 | 10 |
| 4530 17 0660 | 2.5x60 | T6 | 145 | 15 | 10 |
| 4530 17 0760 | 3x60 | T7 | 145 | 15 | 10 |
| 4530 17 0860 | 3x60 | T8 | 145 | 20 | 10 |
| 4530 17 0960 | 3x60 | T9 | 145 | 20 | 10 |
| 4530 17 1060 | 3.5x60 | T10 | 145 | 20 | 10 |

4530 00 0106

Electronic Screwdriver Set Torx (6 Pcs)



Chrome vanadium, Chrom plated and black tip, PP handle

| CODE | CONTENTS | g | □ |
|--------------|------------------------------|-----|---|
| 4530 00 1006 | T5 - T6 - T7 - T8 - T9 - T10 | 115 | 6 |

4540 19 0190

Hupcap and Clip Remover

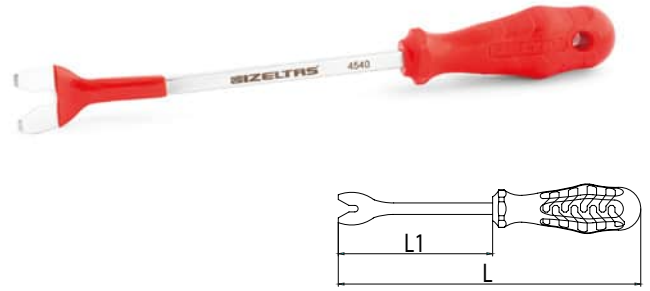

Chrom vanadium, Chrom plated, PP insulated

| CODE | L mm | L1 | g | □ |
|--------------|------|-----|-----|----|
| 4540 19 0190 | 290 | 180 | 160 | 10 |

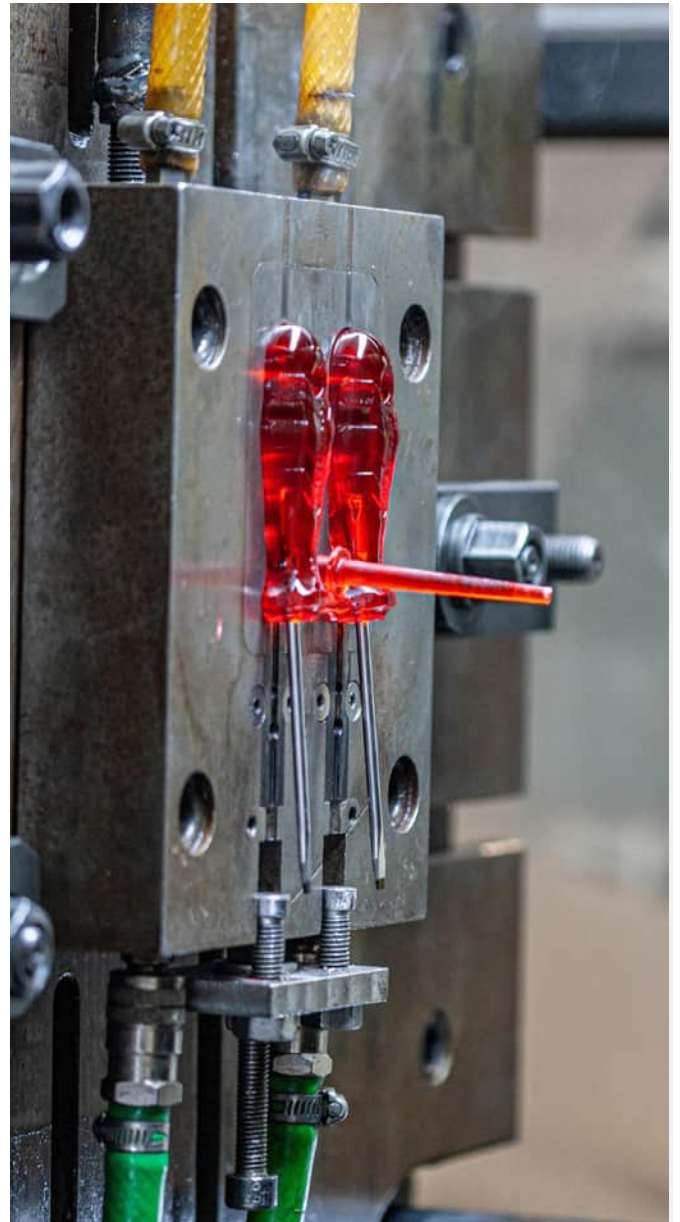

4765

Nut Spinner With T-Handle (mm)

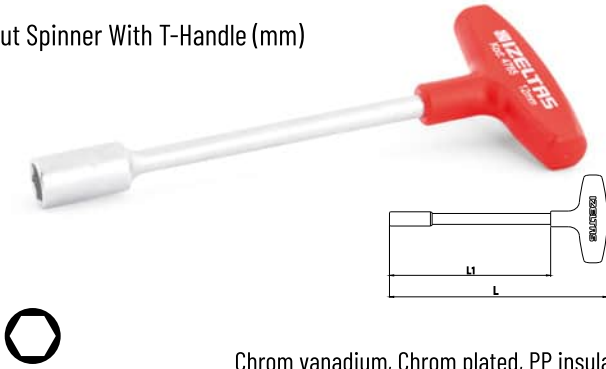

Chrom vanadium, Chrom plated, PP insulated

| CODE | mm | L mm | L1 mm | g | □ |
|--------------|-----|------|-------|-----|----|
| 4765 19 0040 | 4 | 185 | 135 | 75 | 10 |
| 4765 19 0050 | 5 | 185 | 135 | 75 | 10 |
| 4765 19 0055 | 5.5 | 185 | 135 | 75 | 10 |
| 4765 19 0060 | 6 | 185 | 135 | 75 | 10 |
| 4765 19 0070 | 7 | 185 | 135 | 90 | 10 |
| 4765 19 0080 | 8 | 185 | 135 | 95 | 10 |
| 4765 19 0090 | 9 | 185 | 135 | 100 | 10 |
| 4765 19 0100 | 10 | 185 | 135 | 100 | 10 |
| 4765 19 0110 | 11 | 185 | 135 | 110 | 10 |
| 4765 19 0120 | 12 | 185 | 135 | 110 | 10 |
| 4765 19 0130 | 13 | 185 | 135 | 115 | 10 |
| 4765 19 0140 | 14 | 185 | 135 | 115 | 10 |

4770

Nut Spinner (mm)

TS 3793
DIN 3125



Chrom vanadium, Chrom plated, PP insulated

| CODE | mm | L mm | L1 mm | g | □ |
|--------------|-----|------|-------|-----|----|
| 4770 19 0040 | 4 | 220 | 125 | 80 | 10 |
| 4770 19 0050 | 5 | 220 | 125 | 80 | 10 |
| 4770 19 0055 | 5.5 | 220 | 125 | 80 | 10 |
| 4770 19 0060 | 6 | 220 | 125 | 80 | 10 |
| 4770 19 0070 | 7 | 230 | 125 | 100 | 10 |
| 4770 19 0080 | 8 | 230 | 125 | 110 | 10 |
| 4770 19 0090 | 9 | 230 | 125 | 115 | 10 |
| 4770 19 0100 | 10 | 230 | 125 | 115 | 10 |
| 4770 19 0110 | 11 | 230 | 125 | 130 | 10 |
| 4770 19 0120 | 12 | 230 | 125 | 135 | 10 |
| 4770 19 0130 | 13 | 230 | 125 | 140 | 10 |
| 4770 19 0140 | 14 | 230 | 125 | 140 | 10 |



4770 00 8108

Nut Spinner Set (8 Pcs, mm)



| CODE | CONTENTS | g | □ |
|--------------|-----------------------------------|------|---|
| 4770 00 8108 | 6 - 7 - 8 - 9 - 10 - 11 - 12 - 13 | 2145 | 8 |

4773

Nut Spinner, Electrician Blade Insulated 1000V

± 1000 V
IEC 60900



Chrome vanadium, Two Component Insulated

| CODE | mm | L mm | L1 mm | g | |
|--------------|-----|------|-------|-----|----|
| 4773 19 0040 | 4 | 220 | 125 | 90 | 10 |
| 4773 19 0050 | 5 | 220 | 125 | 90 | 10 |
| 4773 19 0055 | 5.5 | 220 | 125 | 90 | 10 |
| 4773 19 0060 | 6 | 220 | 125 | 90 | 10 |
| 4773 19 0070 | 7 | 230 | 125 | 110 | 10 |
| 4773 19 0080 | 8 | 230 | 125 | 120 | 10 |
| 4773 19 0090 | 9 | 230 | 125 | 125 | 10 |
| 4773 19 0100 | 10 | 230 | 125 | 125 | 10 |
| 4773 19 0110 | 11 | 230 | 125 | 140 | 10 |
| 4773 19 0120 | 12 | 230 | 125 | 145 | 10 |
| 4773 19 0130 | 13 | 230 | 125 | 150 | 10 |
| 4773 19 0140 | 14 | 230 | 125 | 150 | 10 |

4773 00 8108

Nut Spinner, Electrician Blade Insulated Set (8 Pcs) 1000V



| CODE | CONTENTS | g | |
|--------------|-----------------------------------|------|---|
| 4773 00 8108 | 6 - 7 - 8 - 9 - 10 - 11 - 12 - 13 | 2225 | 8 |

4775

Torx®
Torx® Screwdriver

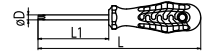

Chrome vanadium, Chrom plated and blackened, PP handle

| CODE | øDxL1 mm | | L mm | g | |
|--------------|----------|-----|------|-----|----|
| 4775 18 0010 | 4x80 | T10 | 165 | 35 | 10 |
| 4775 18 0015 | 4x80 | T15 | 165 | 35 | 10 |
| 4775 18 0020 | 4x100 | T20 | 185 | 40 | 10 |
| 4775 18 0025 | 4.5x100 | T25 | 185 | 40 | 10 |
| 4775 18 0027 | 5x125 | T27 | 220 | 60 | 10 |
| 4775 18 0030 | 6x125 | T30 | 220 | 70 | 10 |
| 4775 18 0040 | 7x125 | T40 | 230 | 100 | 10 |
| 4775 18 0045 | 8x125 | T45 | 230 | 120 | 10 |

4775 00 8107

Torx® Screwdriver Set (7 Pcs)



| CODE | CONTENTS | g | |
|--------------|---|-----|---|
| 4775 00 8107 | T10 - T15 - T20 - T25 - T27 - T30 - T40 | 380 | 7 |

4776

Torx® Screwdriver / Tamper Resistance

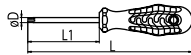

Chrome vanadium, Chrom plated and blackened, PP handle

| CODE | σDxL1 mm | ☆ | L mm | g | □ |
|--------------|----------|------|------|-----|----|
| 4776 18 0009 | 4x60 | TR9 | 145 | 35 | 10 |
| 4776 18 0010 | 4x80 | TR10 | 165 | 35 | 10 |
| 4776 18 0015 | 4x80 | TR15 | 165 | 40 | 10 |
| 4776 18 0020 | 4x100 | TR20 | 185 | 40 | 10 |
| 4776 18 0025 | 4.5x100 | TR25 | 185 | 45 | 10 |
| 4776 18 0027 | 5x125 | TR27 | 220 | 60 | 10 |
| 4776 18 0030 | 6x125 | TR30 | 220 | 70 | 10 |
| 4776 18 0040 | 7x125 | TR40 | 230 | 100 | 10 |

4776 00 8107

Torx® Screwdriver / Tamper Resistance Set (7 Pcs)



| CODE | CONTENTS | g | □ |
|--------------|--|-----|---|
| 4776 00 8107 | TR10 - TR15 - TR20 - TR25 - TR27 - TR30 - TR40 | 380 | 7 |

4780 19 6120

Screwdriver, Magnetic Bit Holder (Long)



| CODE | mm | L mm | L1 mm | g | □ | € |
|--------------|-----|------|-------|-----|----|---|
| 4780 19 6120 | 6.3 | 230 | 120 | 105 | 10 | |

4783 19 6120

Screwdriver, Magnetic Bit Holder Insulated 1000V

⚡ 1000 V
IEC 60900



| CODE | mm | L mm | L1 mm | g | □ |
|--------------|-----|------|-------|-----|----|
| 4783 19 6120 | 6.3 | 230 | 120 | 115 | 10 |

4785 19 6330

Screwdriver, Magnetic Bit Holder, (Short)



| CODE | mm | L mm | L1 mm | g | □ |
|--------------|-----|------|-------|----|----|
| 4785 19 6330 | 6.3 | 130 | 30 | 60 | 10 |

4790 19 6360

Screwdriver Universal Bit Holder (Magnetic)



| CODE | mm | mm | L mm | g | □ |
|--------------|-----|-----|------|----|----|
| 4790 26 6360 | 6.3 | 6.3 | 60 | 25 | 10 |

4795 10 0010

Magnetic Bit Holder With T-Handle



| KOD CODE | mm | L mm | L1 mm | g | |
|--------------|-----|------|-------|----|----|
| 4795 19 0010 | 6.3 | 180 | 130 | 60 | 10 |

4788 19 6160

Screwdriver, Magnetic Bit Holder, Flexible



| CODE | mm | L mm | L1 mm | g | |
|--------------|-----|------|-------|-----|----|
| 4788 19 6160 | 6.3 | 285 | 175 | 130 | 10 |

4805

Socket Adapter



| CODE | | L mm | g | |
|----------------|-----------------|------|----|----|
| 4805 20 5010 | 1/4" M - 1/4" M | 50 | 20 | 10 |
| ★ 4805 20 5011 | 1/4" M - 1/2" M | 50 | 25 | 10 |

4815 00 6107

Screwdriver - Interchangeable Bits Set (7 pcs)



| CODE | CONTENTS | g | |
|--------------|--|-----|---|
| 4815 00 6107 | 100mm - Handle Ph1x4.5 - Ph2x5.5 - Ph3x7 Pz1x4.5 - Pz2x5.5 - Pz3x7 | 140 | 7 |

4800 00 8106

Bit Set (6 Pcs)



| KOD CODE | CONTENTS | g | |
|--------------|-------------------|----|---|
| 4800 00 8106 | 0.6x4.5 - 0.8x5.5 | 50 | 6 |
| | Ph1 - Ph2 - Ph3 | | |
| | T27 | | |

4800 00 8110

Bit Set (10 Pcs)



| KOD CODE | CONTENTS | g | |
|--------------|------------------------------|----|----|
| 4800 00 8110 | 0.6x4.5 - 0.8x5.5 1.2x6.5 | 55 | 10 |
| | Ph1 - Ph2 - Ph3 | | |
| | T25 - T27 - T30 - T40 | | |

4800 00 8131

Bit Set In Plastic Case (31 Pcs)



| CODE | CONTENTS | g | |
|--------------|-------------------|-----|-------|
| 4800 00 8131 | 0.6x4.5 - 0.8x5.5 | 240 | 3 - 3 |
| | 1.2x6.5 | | 4 |
| | Ph1 | | 3 |
| | Ph2 - Ph3 | | 6 - 6 |
| | T27 | | 2 |
| | T25 - T30 - T40 | | 1-1-1 |
| | 6.3 x 60 Adaptör | | 1 |

★ It is Limited by Stocks.

13000 005429

Multi Bit Ratcheting Screwdriver Set (8 Pcs)



| CODE | CONTENTS | g | |
|--------------|---|-----|---|
| | Bit Set (6 Pcs) | | |
| | 0.6x4.5 - 0.8x5.5 | | 6 |
| | Ph1 - Ph2 - Ph3 | | |
| | T27 | 340 | |
| 13000 005278 | Ratcheting Screwdriver (175mm) | | 1 |
| 4790 26 6360 | Screwdriver Universal Bit Holder (Magnetic) | | 1 |



13000 005278

Ratcheting Screwdriver



| CODE | mm | L mm | g | |
|--------------|-----|------|-----|---|
| 13000 005278 | 6.3 | 175 | 130 | 5 |

4810-4860
Bits Flat

25mm-50mm-75mm-100mm-150mm



Chrom vanadium

| CODE | | L mm | g | |
|--------------|---------|---------|-------|----|
| 4810 20 0645 | 0.6x4.5 | 25 | 5 | 10 |
| 4810 20 0855 | 0.8x5.5 | 25 | 5 | 10 |
| 4810 20 1265 | 1.2x6.5 | 25 | 5 | 10 |
| 4810 20 5645 | 0.6x4.5 | 50 | 10 | 10 |
| 4810 20 5855 | 0.8x5.5 | 50 | 10 | 10 |
| 4810 20 5265 | 1.2x6.5 | 50 | 10 | 10 |
| 4860 20 0745 | 0.6x4.5 | 75 | 11 | 10 |
| 4860 20 0755 | 0.8x5.5 | 75 | 13 | 10 |
| 4860 20 0765 | 1.2x6.5 | 75 | 15 | 10 |
| 4860 20 1045 | 0.6x4.5 | 100 | 14 | 10 |
| 4860 20 1055 | 0.8x5.5 | 100 | 17 | 10 |
| 4860 20 1065 | 1.2x6.5 | 100 | 18 | 10 |
| 4860 20 1545 | 0.6x4.5 | 150 | 21 | 10 |
| 4860 20 1555 | 0.8x5.5 | 150 | 26 | 10 |
| 4860 20 1565 | 1.2x6.5 | 150 | 28 | 10 |

4820-4870
Bits Phillips

25mm-50mm-75mm-100mm-150mm



Chrom vanadium

| CODE | | L mm | g | |
|--------------|-----|---------|-------|----|
| 4820 21 0001 | Ph1 | 25 | 5 | 10 |
| 4820 21 0002 | Ph2 | 25 | 5 | 10 |
| 4820 21 0003 | Ph3 | 25 | 5 | 10 |
| 4820 21 0011 | Ph1 | 50 | 10 | 10 |
| 4820 21 0012 | Ph2 | 50 | 10 | 10 |
| 4820 21 0013 | Ph3 | 50 | 10 | 10 |
| 4870 21 0701 | Ph1 | 75 | 17 | 10 |
| 4870 21 0702 | Ph2 | 75 | 18 | 10 |
| 4870 21 0703 | Ph3 | 75 | 18 | 10 |
| 4870 21 1001 | Ph1 | 100 | 20 | 10 |
| 4870 21 1002 | Ph2 | 100 | 24 | 10 |
| 4870 21 1003 | Ph3 | 100 | 24 | 10 |
| 4870 21 1501 | Ph1 | 150 | 23 | 10 |
| 4870 21 1502 | Ph2 | 150 | 33 | 10 |
| 4870 21 1503 | Ph3 | 150 | 33 | 10 |

4810
Flat Bit Set (25 mm)

| CODE | | g | |
|--------------|---------|-------|----|
| 4810 00 0645 | 0.6x4.5 | 45 | 10 |
| 4810 00 0855 | 0.8x5.5 | 50 | 10 |
| 4810 00 1265 | 1.2x6.5 | 55 | 10 |

4820
Phillips Bit Set (25 mm)

| CODE | | g | |
|--------------|-----|-------|----|
| 4820 00 0001 | Ph1 | 50 | 10 |
| 4820 00 0002 | Ph2 | 50 | 10 |
| 4820 00 0003 | Ph3 | 55 | 10 |

4825-4880

Bits Pozidriv
25mm-50mm-75mm-100mm-150mm



Chrom vanadium

| CODE | | L mm | g | |
|--------------|-----|------|----|----|
| 4825 21 0001 | Pz1 | 25 | 5 | 10 |
| 4825 21 0002 | Pz2 | 25 | 5 | 10 |
| 4825 21 0003 | Pz3 | 25 | 5 | 10 |
| 4825 21 0011 | Pz1 | 50 | 10 | 10 |
| 4825 21 0012 | Pz2 | 50 | 10 | 10 |
| 4825 21 0013 | Pz3 | 50 | 10 | 10 |
| 4880 21 0701 | Pz1 | 75 | 17 | 10 |
| 4880 21 0702 | Pz2 | 75 | 18 | 10 |
| 4880 21 0703 | Pz3 | 75 | 18 | 10 |
| 4880 21 1001 | Pz1 | 100 | 20 | 10 |
| 4880 21 1002 | Pz2 | 100 | 24 | 10 |
| 4880 21 1003 | Pz3 | 100 | 24 | 10 |
| 4880 21 1501 | Pz1 | 150 | 23 | 10 |
| 4880 21 1502 | Pz2 | 150 | 33 | 10 |
| 4880 21 1503 | Pz3 | 150 | 33 | 10 |

4830-4885

Bits Torx®
25mm-50mm-75mm-100mm-150mm



Chrom vanadium

| CODE | | L mm | g | |
|--------------|-----|------|----|----|
| 4830 21 0025 | T25 | 25 | 5 | 10 |
| 4830 21 0027 | T27 | 25 | 5 | 10 |
| 4830 21 0030 | T30 | 25 | 5 | 10 |
| 4830 21 0040 | T40 | 25 | 5 | 10 |
| 4830 21 0125 | T25 | 50 | 10 | 10 |
| 4830 21 0127 | T27 | 50 | 10 | 10 |
| 4830 21 0130 | T30 | 50 | 10 | 10 |
| 4830 21 0140 | T40 | 50 | 10 | 10 |
| 4885 21 0725 | T25 | 75 | 12 | 10 |
| 4885 21 0727 | T27 | 75 | 15 | 10 |
| 4885 21 0730 | T30 | 75 | 15 | 10 |
| 4885 21 0740 | T40 | 75 | 17 | 10 |
| 4885 21 1025 | T25 | 100 | 15 | 10 |
| 4885 21 1027 | T27 | 100 | 20 | 10 |
| 4885 21 1030 | T30 | 100 | 20 | 10 |
| 4885 21 1040 | T40 | 100 | 23 | 10 |
| 4885 21 1525 | T25 | 150 | 20 | 10 |
| 4885 21 1527 | T27 | 150 | 25 | 10 |
| 4885 21 1530 | T30 | 150 | 25 | 10 |
| 4885 21 1540 | T40 | 150 | 33 | 10 |

4825

Pozidriv Bit Set (25 mm)



| CODE | | g | |
|--------------|-----|----|----|
| 4825 00 0001 | Pz1 | 50 | 10 |
| 4825 00 0002 | Pz2 | 55 | 10 |
| 4825 00 0003 | Pz3 | 55 | 10 |

4830

Torx® Bit Set (25 mm)



| CODE | | g | |
|--------------|-----|----|----|
| 4830 00 0025 | T25 | 50 | 10 |
| 4830 00 0027 | T27 | 50 | 10 |
| 4830 00 0030 | T30 | 55 | 10 |
| 4830 00 0040 | T40 | 60 | 10 |

Palm Ratchet Bit Holder



| CODE | Ø | L mm | g | □ |
|--------------|----|------|-----|---|
| 4784 19 6346 | 46 | 26,5 | 100 | 5 |

Bit Set, Long Type 100 mm (13 Pcs)



100mm

| CODE | CONTENTS | g | □ |
|--------------|--|-----|----|
| 4850 00 1013 | Flat Bits 0.6x4.5 - 0.8x 5.5 1.2x6.5 | 263 | 13 |
| | Phillips Bits Ph1 - Ph2 - Ph3 | | |
| | Pozidriv Bits Pz1 - Pz2 - Pz3 | | |
| | Torx® Bits T25 - T27 - T30 - T40 | | |

Bit Set, Long Type 75 mm (13 Pcs)



75mm

| CODE | CONTENTS | g | □ |
|--------------|--|-----|----|
| 4850 00 0713 | Flat Bits 0.6x4.5 - 0.8x 5.5 1.2x6.5 | 204 | 13 |
| | Phillips Bits Ph1 - Ph2 - Ph3 | | |
| | Pozidriv Bits Pz1 - Pz2 - Pz3 | | |
| | Torx® Bits T25 - T27 T30 - T40 | | |

Bit Set, Long Type 150 mm (13 Pcs)



150mm

| CODE | CONTENTS | g | □ |
|--------------|--|-----|----|
| 4850 00 1513 | Flat Bits 0.6x4.5 - 0.8x 5.5 1.2x6.5 | 356 | 13 |
| | Phillips Bits Ph1 - Ph2 - Ph3 | | |
| | Pozidriv Bits Pz1 - Pz2 - Pz3 | | |
| | Torx® Bits T25 - T27 - T30 - T40 | | |

4900

Hex Key Wrench Standard Size (mm)



TS ISO 2936
DIN ISO 2936

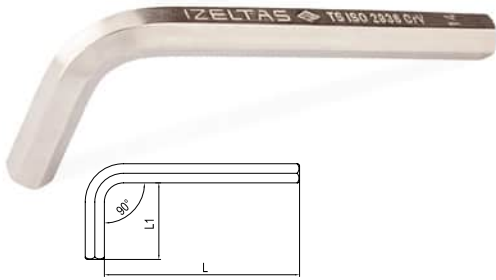

Chrom Vanadium, Nickel Plated

| CODE | mm | L mm | L1 mm | g | |
|--------------|-----|------|-------|------|----|
| 4900 22 0015 | 1.5 | 45 | 14 | 1.5 | 10 |
| 4900 22 0020 | 2 | 50 | 16 | 2 | 10 |
| 4900 22 0025 | 2.5 | 56 | 18 | 4 | 10 |
| 4900 22 0030 | 3 | 63 | 20 | 6 | 10 |
| 4900 22 0035 | 3.5 | 66 | 22 | 8 | 10 |
| 4900 22 0040 | 4 | 70 | 25 | 10 | 10 |
| 4900 22 0050 | 5 | 80 | 28 | 20 | 10 |
| 4900 22 0060 | 6 | 90 | 32 | 30 | 10 |
| 4900 22 0070 | 7 | 95 | 34 | 40 | 10 |
| 4900 22 0080 | 8 | 100 | 36 | 55 | 10 |
| 4900 22 0090 | 9 | 105 | 38 | 75 | 10 |
| 4900 22 0100 | 10 | 112 | 40 | 100 | 10 |
| 4900 22 0120 | 12 | 125 | 45 | 160 | 10 |
| 4900 22 0140 | 14 | 140 | 56 | 250 | 5 |
| 4900 22 0160 | 16 | 152 | 60 | 375 | 5 |
| 4900 22 0170 | 17 | 160 | 63 | 425 | 5 |
| 4900 22 0190 | 19 | 180 | 70 | 610 | 5 |
| 4900 22 0220 | 22 | 200 | 80 | 940 | 5 |
| 4900 22 0240 | 24 | 224 | 90 | 1250 | 5 |

4900

Hex Key Wrench Set Standard Size (mm)



| CODE | CONTENTS | g | |
|--------------|--|-----|----|
| 4900 00 3110 | 2 - 2.5 - 3 - 4 - 5 - 6 7 - 8 - 9 - 10 | 400 | 10 |
| 4900 00 3112 | 2 - 2.5 - 3 - 3.5 - 4 - 5 6 - 7 - 8 - 9 - 10 - 12 | 565 | 12 |

4901

Hex Key Wrench (SAE)

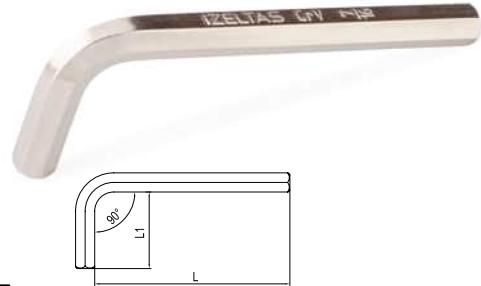

Chrom Vanadium, Nickel Plated

| CODE | inch | L mm | L1 mm | g | |
|--------------|-------|------|-------|-----|----|
| 4901 22 1984 | 5/64" | 50 | 16 | 2 | 10 |
| 4901 22 2381 | 3/32" | 54 | 18 | 4 | 10 |
| 4901 22 3125 | 1/8" | 58 | 20 | 5 | 10 |
| 4901 22 3968 | 5/32" | 62 | 22 | 10 | 10 |
| 4901 22 4762 | 3/16" | 68 | 24 | 15 | 10 |
| 4901 22 5556 | 7/32" | 74 | 26 | 25 | 10 |
| 4901 22 6350 | 1/4" | 82 | 28 | 35 | 10 |
| 4901 22 7937 | 5/16" | 94 | 32 | 55 | 10 |
| 4901 22 9825 | 3/8" | 106 | 38 | 90 | 10 |
| 4901 22 1111 | 7/16" | 118 | 42 | 130 | 10 |
| 4901 22 1270 | 1/2" | 132 | 46 | 190 | 10 |
| 4901 22 1428 | 9/16" | 144 | 52 | 265 | 10 |
| 4901 22 1587 | 5/8" | 156 | 58 | 365 | 10 |
| 4901 22 1905 | 3/4" | 176 | 66 | 600 | 5 |

4901

Hex Key Wrench Set (SAE)



| CODE | CONTENTS | g | |
|--------------|---|-----|----|
| 4901 00 3110 | 5/64" - 3/32" - 1/8" - 5/32" 3/16" - 7/32" - 1/4" - 5/16" 3/8" - 7/16" | 405 | 10 |
| 4901 00 3112 | 5/64" - 3/32" - 1/8" - 5/32" 3/16" - 7/32" - 1/4" - 5/16" 3/8" - 7/16" - 1/2" - 9/16" | 855 | 12 |

4903

Hex Key Wrench Long Pattern (mm)



TS ISO 2936
DIN ISO 2936



Chrom Vanadium, Nickel Plated

| CODE | mm | L mm | L1 mm | g | |
|--------------|-----|-------|-------|------|----|
| 4903 22 0020 | 2 | 100 | 16 | 3 | 10 |
| 4903 22 0025 | 2.5 | 112 | 18 | 5 | 10 |
| 4903 22 0030 | 3 | 126 | 20 | 10 | 10 |
| 4903 22 0035 | 3.5 | 136.5 | 22 | 15 | 10 |
| 4903 22 0040 | 4 | 140 | 25 | 20 | 10 |
| 4903 22 0050 | 5 | 160 | 28 | 30 | 10 |
| 4903 22 0060 | 6 | 180 | 32 | 50 | 10 |
| 4903 22 0070 | 7 | 190 | 34 | 80 | 10 |
| 4903 22 0080 | 8 | 200 | 36 | 100 | 10 |
| 4903 22 0090 | 9 | 210 | 38 | 145 | 10 |
| 4903 22 0100 | 10 | 224 | 40 | 180 | 10 |
| 4903 22 0120 | 12 | 250 | 45 | 285 | 10 |
| 4903 22 0140 | 14 | 280 | 56 | 460 | 5 |
| 4903 22 0160 | 16 | 290 | 60 | 625 | 5 |
| 4903 22 0170 | 17 | 320 | 63 | 750 | 5 |
| 4903 22 0190 | 19 | 360 | 70 | 1100 | 5 |

4905

Hex Key Wrench Ballpoint (mm)



Chrom Vanadium, Nickel Plated

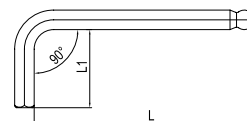

| CODE | mm | L mm | L1 mm | g | |
|--------------|-----|------|-------|-----|----|
| 4905 22 0020 | 2 | 50 | 16 | 3 | 10 |
| 4905 22 0025 | 2.5 | 56 | 18 | 4 | 10 |
| 4905 22 0030 | 3 | 63 | 20 | 5 | 10 |
| 4905 22 0040 | 4 | 70 | 25 | 10 | 10 |
| 4905 22 0050 | 5 | 80 | 28 | 20 | 10 |
| 4905 22 0060 | 6 | 90 | 32 | 30 | 10 |
| 4905 22 0080 | 8 | 100 | 36 | 55 | 10 |
| 4905 22 0100 | 10 | 112 | 40 | 100 | 10 |

4903

Hex Key Wrench Set Long Pattern (mm)



| CODE | CONTENTS | g | |
|--------------|--|-----|----|
| 4903 00 3110 | 2 - 2.5 - 3 - 4 - 5 - 6 7 - 8 - 9 - 10 | 660 | 10 |
| 4903 00 3112 | 2 - 2.5 - 3 - 3.5 - 4 - 5 6 - 7 - 8 - 9 - 10 - 12 | 940 | 12 |

4905 00 7108

Hex Key Wrench Ballpoint Set (8 Pcs, mm)

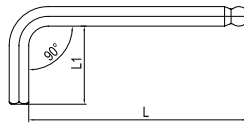

| CODE | CONTENTS | g | |
|--------------|-----------------------------------|-----|---|
| 4905 00 7108 | 2 - 2.5 - 3 - 4 5 - 6 - 8 - 10 | 275 | 8 |

4906
Hex Key Wrench Ballpoint Long Pattern (mm)

Chrom Vanadium, Nickel Plated

| CODE | mm | L mm | L1 mm | g | |
|--------------|-----|------|-------|-----|----|
| 4906 22 0015 | 1.5 | 79 | 12 | 1.5 | 10 |
| 4906 22 0020 | 2 | 84 | 16 | 3 | 10 |
| 4906 22 0025 | 2.5 | 89 | 16 | 5 | 10 |
| 4906 22 0030 | 3 | 99 | 18 | 7 | 10 |
| 4906 22 0040 | 4 | 109 | 23 | 13 | 10 |
| 4906 22 0050 | 5 | 125 | 26 | 25 | 10 |
| 4906 22 0060 | 6 | 150 | 28 | 42 | 10 |
| 4906 22 0080 | 8 | 167 | 33 | 85 | 10 |
| 4906 22 0100 | 10 | 190 | 37 | 150 | 10 |

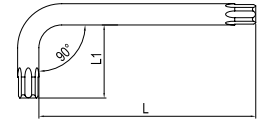
4910
Torx® Key Wrench

Chrom Vanadium, Nickel Plated

| CODE | ★ | L mm | L1 mm | g | |
|--------------|-----|------|-------|-----|----|
| 4910 22 0006 | T6 | 42 | 16 | 2 | 10 |
| 4910 22 0007 | T7 | 48 | 16 | 2 | 10 |
| 4910 22 0008 | T8 | 48 | 16 | 3 | 10 |
| 4910 22 0009 | T9 | 48 | 16 | 3 | 10 |
| 4910 22 0010 | T10 | 51 | 17 | 4 | 10 |
| 4910 22 0015 | T15 | 54 | 18 | 5 | 10 |
| 4910 22 0020 | T20 | 57 | 19 | 5 | 10 |
| 4910 22 0025 | T25 | 60 | 20 | 10 | 10 |
| 4910 22 0027 | T27 | 64 | 21 | 15 | 10 |
| 4910 22 0030 | T30 | 70 | 24 | 20 | 10 |
| 4910 22 0040 | T40 | 76 | 26 | 30 | 10 |
| 4910 22 0045 | T45 | 83 | 29 | 40 | 10 |
| 4910 22 0050 | T50 | 95 | 32 | 60 | 10 |
| 4910 22 0055 | T55 | 108 | 35 | 125 | 10 |
| 4910 22 0060 | T60 | 120 | 38 | 185 | 10 |

4906 00 3109
Hex Key Wrench Ballpoint Long Pattern Set (9 Pcs, mm)

| CODE | CONTENTS | g | |
|--------------|---|-----|---|
| 4906 00 3109 | 1.5 - 2 - 2.5 - 3 - 4 - 5 - 6 8 - 10 | 355 | 9 |

4910 00 7108
Torx® Key Wrench Set (8 Pcs)

| CODE | CONTENTS | g | |
|--------------|--|-----|---|
| 4910 00 7108 | T9 - T10 - T15 T20 - T25 - T27 T30 - T40 | 155 | 8 |

4912 00 3107

Hex Key Wrench Folding Set (7 Pcs, mm)



Chrom vanadium

| CODE | CONTENTS | g | □ |
|--------------|------------------------------|-----|---|
| 4912 00 3107 | 2.5 - 3 - 4 - 5 - 6 - 8 - 10 | 355 | 1 |

4912 00 0007

Hex Key Wrench Folding Set (7 Pcs, mm)



Chrom vanadium

| CODE | CONTENTS | g | □ |
|--------------|--------------------------------|-----|---|
| 4912 00 0007 | 1.5 - 2 - 2.5 3 - 4 - 5 - 6 | 130 | 1 |

4909

T Handle Torx® Key Wrench

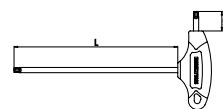

Chrom vanadium, Nickel plated

| CODE | ★ | L1 mm | L2 mm | g | □ |
|--------------|-----|-------|-------|-----|---|
| 4909 22 0009 | T9 | 111.5 | 21 | 15 | 5 |
| 4909 22 0010 | T10 | 111.5 | 21 | 15 | 5 |
| 4909 22 0015 | T15 | 105 | 16 | 20 | 5 |
| 4909 22 0020 | T20 | 105 | 16 | 25 | 5 |
| 4909 22 0025 | T25 | 129 | 25 | 50 | 5 |
| 4909 22 0027 | T27 | 129 | 25 | 50 | 5 |
| 4909 22 0030 | T30 | 122 | 20 | 105 | 5 |
| 4909 22 0040 | T40 | 153 | 35 | 100 | 5 |

4909 00 8108

T Handle Torx Key Wrench Set (8 Pcs)



| CODE | CONTENTS | g | □ |
|--------------|---|-----|---|
| 4909 00 8108 | T9 - T10 - T15 - T20 T25 - T27 - T30 - T40 | 407 | 8 |

4920

Hex Key Wrench T - Handle (mm)

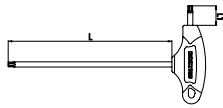

Chrom Vanadium

| CODE | mm | L mm | L1 mm | g | |
|--------------|-----|------|-------|-----|---|
| 4920 22 0025 | 2.5 | 102 | 17.5 | 10 | 5 |
| 4920 22 0030 | 3 | 118 | 21 | 15 | 5 |
| 4920 22 0040 | 4 | 131 | 24.5 | 35 | 5 |
| 4920 22 0050 | 5 | 141 | 22 | 50 | 5 |
| 4920 22 0060 | 6 | 154 | 26 | 85 | 5 |
| 4920 22 0070 | 7 | 174 | 36 | 120 | 5 |
| 4920 22 0080 | 8 | 184 | 34 | 165 | 5 |
| 4920 22 0100 | 10 | 209 | 45.5 | 260 | 5 |

4921

Hex Key Wrench T - Handle Ballpoint (mm)

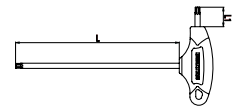

Chrom Vanadium

| CODE | mm | L mm | L1 mm | g | |
|--------------|-----|------|-------|-----|---|
| 4921 22 0025 | 2.5 | 102 | 17.5 | 10 | 5 |
| 4921 22 0030 | 3 | 118 | 21 | 15 | 5 |
| 4921 22 0040 | 4 | 131 | 24.5 | 35 | 5 |
| 4921 22 0050 | 5 | 141 | 22 | 50 | 5 |
| 4921 22 0060 | 6 | 154 | 26 | 85 | 5 |
| 4921 22 0070 | 7 | 174 | 36 | 120 | 5 |
| 4921 22 0080 | 8 | 184 | 34 | 165 | 5 |
| 4921 22 0100 | 10 | 209 | 45.5 | 260 | 5 |

4920 00 8108

Hex Key Wrench T - Handle Set (8 Pcs, mm)



| CODE | CONTENTS | g | |
|--------------|-----------------------------------|-----|---|
| 4920 00 8108 | 2.5 - 3 - 4 - 5 6 - 7 - 8 - 10 | 760 | 8 |

4921 00 8108

Hex Key Wrench T - Handle Ballpoint Set (8 Pcs, mm)



| CODE | CONTENTS | g | |
|--------------|-----------------------------------|-----|---|
| 4921 00 8108 | 2.5 - 3 - 4 5 - 6 - 7 - 8 - 10 | 755 | 8 |



CHISELS AND HAMMERS

Chisels

Punches

Hammers

Adzes



SAFETY HAMMER



İZELTAŞ USTA İŞİ
SOHBETLER

5010

TS 531

Wood Chisel



Special steel, Induction hardened tips, PP Handle

| CODE | a mm | L mm | L1 mm | g | □ |
|--------------|------|------|-------|-----|---|
| 5010 23 0006 | 6 | 240 | 120 | 115 | 5 |
| 5010 23 0008 | 8 | 242 | 122 | 125 | 5 |
| 5010 23 0010 | 10 | 244 | 124 | 135 | 5 |
| 5010 23 0012 | 12 | 246 | 126 | 135 | 5 |
| 5010 23 0014 | 14 | 248 | 128 | 145 | 5 |
| 5010 23 0016 | 16 | 250 | 130 | 150 | 5 |
| 5010 23 0018 | 18 | 252 | 132 | 160 | 5 |
| 5010 23 0020 | 20 | 254 | 134 | 170 | 5 |
| 5010 23 0022 | 22 | 256 | 136 | 190 | 5 |
| 5010 23 0024 | 24 | 258 | 138 | 195 | 5 |
| 5010 23 0026 | 26 | 260 | 140 | 200 | 5 |
| 5010 23 0030 | 30 | 264 | 144 | 205 | 5 |

5010 00 8106

Wood Chisel Set (6 Pcs)



| CODE | CONTENTS | g | □ |
|--------------|------------------------------|-----|---|
| 5010 00 8106 | 10 - 12 - 14 16 - 18 - 20 | 985 | 6 |

5500



TS 492
DIN 6453

Flat Cold Chisel



Special steel, Chrom plated

| CODE | L mm | a mm | g | □ |
|--------------|------|------|-----|---|
| 5500 23 0100 | 100 | 17 | 75 | 5 |
| 5500 23 0125 | 125 | 19 | 110 | 5 |
| 5500 23 0150 | 150 | 21 | 180 | 5 |
| 5500 23 0175 | 175 | 24 | 245 | 5 |
| 5500 23 0200 | 200 | 27 | 340 | 5 |
| 5500 23 0250 | 250 | 30 | 525 | 5 |
| 5500 23 0300 | 300 | 30 | 635 | 5 |

5500

Flat Cold Chisel (With Safety Handle)



TS 492
DIN 6453



Special steel, Chrom plated

| CODE | L mm | a mm | g | □ |
|--------------|------|------|-----|---|
| 5500 23 1250 | 250 | 30 | 700 | 1 |
| 5500 23 1300 | 300 | 30 | 790 | 1 |

5510

Flat Cold Chisel Octagonal

TS 492
DIN 6453



Chrom vanadium

| CODE | L mm | a mm | g | |
|--------------|------|------|-----|----|
| 5510 23 0125 | 125 | 10 | 75 | 10 |
| 5510 23 0150 | 150 | 14 | 125 | 10 |

5520

Cross Cut Chisel

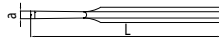

Chrom vanadium

| CODE | L mm | a mm | g | |
|--------------|------|------|-----|----|
| 5520 23 0125 | 130 | 5 | 70 | 10 |
| 5520 23 0150 | 150 | 6 | 110 | 10 |

5540

Center Punch

TS 2338-3
DIN 7250

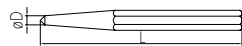

Chrom vanadium

| CODE | L mm | L inch | σD mm | g | |
|----------------|------|--------|-------|-----|----|
| 5540 24 4120 | 120 | 4 3/4" | 4 | 65 | 10 |
| 5540 24 5120 | 120 | 4 3/4" | 5 | 95 | 10 |
| 5540 24 5150 | 150 | 6" | 5 | 115 | 10 |
| ★ 5540 24 0412 | 120 | 4 3/4" | 4 | 65 | 10 |

★ It is Limited by Stocks.

5545

Drift Punch

TS 2338-2
DIN 6458



Chrom vanadium

| CODE | L mm | L inch | σD mm | g | |
|----------------|------|--------|-------|-----|----|
| 5545 24 0002 | 120 | 4 3/4" | 2 | 90 | 10 |
| 5545 24 0003 | 120 | 4 3/4" | 3 | 90 | 10 |
| 5545 24 0004 | 120 | 4 3/4" | 4 | 90 | 10 |
| 5545 24 0005 | 120 | 4 3/4" | 5 | 95 | 10 |
| 5545 24 0006 | 120 | 4 3/4" | 6 | 95 | 10 |
| 5545 24 0007 | 120 | 4 3/4" | 7 | 100 | 10 |
| 5545 24 0008 | 150 | 6" | 8 | 125 | 10 |
| 5545 24 0009 | 150 | 6" | 9 | 130 | 10 |
| 5545 24 0010 | 150 | 6" | 10 | 130 | 10 |
| ★ 5545 24 0012 | 150 | 6" | 12 | 180 | 10 |
| ★ 5545 24 0103 | 120 | 4 3/4" | 3 | 90 | 10 |

5550

Split Pin Punch

TS 2338-1
DIN 6450



Chrom vanadium

| CODE | L mm | L inch | σD mm | g | |
|----------------|------|--------|-------|-----|---|
| 5550 24 0002 | 150 | 6" | 2 | 70 | 5 |
| 5550 24 0003 | 150 | 6" | 3 | 65 | 5 |
| 5550 24 0004 | 150 | 6" | 4 | 65 | 5 |
| 5550 24 0005 | 150 | 6" | 5 | 65 | 5 |
| 5550 24 0006 | 150 | 6" | 6 | 70 | 5 |
| 5550 24 0007 | 150 | 6" | 7 | 100 | 5 |
| 5550 24 0008 | 150 | 6" | 8 | 105 | 5 |
| 5550 24 0009 | 150 | 6" | 9 | 110 | 5 |
| 5550 24 0010 | 150 | 6" | 10 | 120 | 5 |
| ★ 5550 24 0105 | 150 | 6" | 5 | 65 | 5 |

5550 00 1006

Split Pin Punch (6 Pcs)



| CODE | CONTENTS | g | |
|--------------|-----------------------|-----|---|
| 5550 00 1006 | 3 - 4 - 5 - 6 - 7 - 8 | 865 | 6 |

5600 00 6106

Chisel And Punch Set (6 Pcs)



| CODE | CONTENTS | g | □ |
|--------------|--------------------------------|-----|---|
| 5510 23 0125 | 125 Flat Cold Chisel Octagonal | 865 | 1 |
| 5510 23 0150 | 150 Flat Cold Chisel Octagonal | | 1 |
| 5520 23 0125 | 130 Cross Cut Chisel | | 1 |
| 5540 24 4120 | 4x120 Center Punch | | 1 |
| 5550 24 0005 | 5x150 Split PinPunch | | 1 |
| 5545 24 0003 | 3x120 Drift Punch | | 1 |



5700

Belt Punch

DIN 7200

TSEK

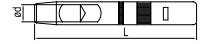

Chrom vanadium, Electrostatically painted

| CODE | mm | L mm | g | □ |
|--------------|----|------|-----|----|
| 5700 24 0003 | 3 | 105 | 35 | 10 |
| 5700 24 0004 | 4 | 105 | 40 | 10 |
| 5700 24 0005 | 5 | 110 | 50 | 10 |
| 5700 24 0006 | 6 | 110 | 60 | 10 |
| 5700 24 0007 | 7 | 115 | 75 | 10 |
| 5700 24 0008 | 8 | 115 | 90 | 10 |
| 5700 24 0009 | 9 | 120 | 100 | 10 |
| 5700 24 0010 | 10 | 120 | 110 | 10 |
| 5700 24 0011 | 11 | 125 | 130 | 5 |
| 5700 24 0012 | 12 | 125 | 165 | 5 |
| 5700 24 0013 | 13 | 130 | 165 | 5 |
| 5700 24 0014 | 14 | 130 | 180 | 5 |
| 5700 24 0015 | 15 | 135 | 245 | 5 |
| 5700 24 0016 | 16 | 135 | 300 | 5 |
| 5700 24 0017 | 17 | 140 | 365 | 5 |
| 5700 24 0018 | 18 | 140 | 380 | 5 |
| 5700 24 0019 | 19 | 145 | 405 | 5 |
| 5700 24 0020 | 20 | 145 | 450 | 5 |

5700

Belt Punch Set

TSEK



| CODE | CONTENTS | g | □ |
|--------------|---|------|----|
| 5700 00 2110 | 3 - 4 - 5 - 6 - 7 8 - 9 - 10 - 11 - 12 | 845 | 10 |
| 5700 00 2112 | 3 - 4 - 5 - 6 - 7 - 8 - 9 10 - 11 - 12 - 13 - 14 | 1180 | 12 |

5800

Machinist Hammer



TS 5-1
DIN 1041



IZELTAS YOUTUBE

Spare parts page 229

Special steel, Induction hardened, Electrostatically painted

| CODE | L mm | L1 mm | g | g | |
|--------------|------|-------|------|------|----|
| 5800 25 0100 | 260 | 82 | 100 | 160 | 10 |
| 5800 25 0200 | 280 | 95 | 200 | 260 | 10 |
| 5800 25 0300 | 300 | 105 | 300 | 395 | 10 |
| 5800 25 0500 | 320 | 118 | 500 | 600 | 5 |
| 5800 25 1000 | 360 | 135 | 1000 | 1095 | 5 |
| 5800 25 1500 | 380 | 145 | 1500 | 1630 | 5 |
| 5800 25 2000 | 400 | 155 | 2000 | 2100 | 5 |

5850

Plastic Hammer



TS 5-2



Spare parts page 229

Durable and easily changeable heads

| CODE | L mm | σD mm | H mm | g | |
|--------------|------|---------------|------|------|---|
| 5850 25 0030 | 300 | 30 | 100 | 345 | 5 |
| 5850 25 0040 | 320 | 40 | 110 | 645 | 5 |
| 5850 25 0050 | 350 | 50 | 120 | 1015 | 5 |

5810

Safety Hammer

TS 5-1



Special steel, Induction hardened, Electrostatically painted

| CODE | L mm | L1 mm | g | g | |
|--------------|------|-------|------|------|---|
| 5810 25 1000 | 360 | 135 | 1000 | 1095 | 5 |
| 5810 25 1500 | 380 | 145 | 1500 | 1630 | 5 |
| 5810 25 2000 | 400 | 155 | 2000 | 2100 | 5 |

Safety Hammer

Connection between the hammer head and the handle is ensured by circular wedge and epoxy glue, while it is also reinforced by sheet metal for safe use.

5870 25 0400

Rubber Hammer



| CODE | L mm | σd mm | h mm | g | g | |
|--------------|------|---------------|------|-----|-----|---|
| 5870 25 0400 | 300 | 47 | 104 | 400 | 540 | 5 |

5865

TS 5-1

Mallet



Spare parts page 229

Special steel

| CODE | L mm | L1 mm | | g | |
|--------------|------|-------|------|------|---|
| 5865 25 1000 | 260 | 95 | 1000 | 1210 | 5 |
| 5865 25 1500 | 280 | 110 | 1500 | 1770 | 5 |

6410 25 0800

TS 748-4

Hatchet

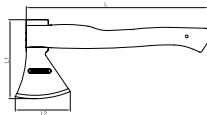

Spare parts page 229

Special steel, Induction hardened, Electrostatically painted

| CODE | L mm | L1 mm | L2 mm | g | g | |
|--------------|------|-------|-------|-----|------|---|
| 6410 25 0800 | 380 | 165 | 115 | 800 | 1065 | 1 |

13000 005248

Hatchet

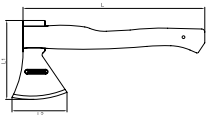

Special steel, Electrostatically painted

| CODE | L mm | L1 mm | L2 mm | g | |
|--------------|------|-------|-------|-----|---|
| 13000 005248 | 270 | 118 | 85 | 600 | 1 |

6400 25 0600

TS 686-2

Adze

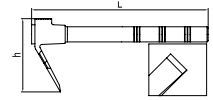

Spare parts page 229

Special steel, Induction hardened, Electrostatically painted, PVC cutting edge protector

| CODE | L mm | h mm | g | g | |
|--------------|------|------|-----|-----|---|
| 6400 25 0600 | 400 | 125 | 400 | 550 | 5 |

6401 25 0600

TS 686-2

Master Adze

Spare parts page 229

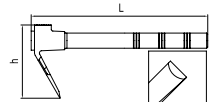

Spare parts page 229

Special steel, Induction hardened, Electrostatically painted, PVC cutting edge protector

| CODE | L mm | h mm | g | g | |
|--------------|------|------|-----|-----|---|
| 6401 25 0600 | 400 | 125 | 400 | 540 | 5 |



ZELTAS
DIN 9131 - 5232

INDUCTION
HARDENED
800 GR

8410



ZELTAS

GENERAL HAND TOOLS

Service Equipment

Riveting Pliers

Clamps

Construction Equipment

Measuring Tapes

Forged Steel Vice

Straight Level

Grease Gun



CABLE STRIPPER (WITH HOOKED BLADE)



03750 50 020

Cable Stripper (With Hooked Blade)



Spare parts page 229

| CODE | SIZE | g | |
|--------------|-------|----|---|
| 03750 50 020 | Ø8-28 | 79 | 5 |

03752 50 625

Cable Stripper



Spare parts page 229

| CODE | SIZE | g | |
|--------------|-------|----|---|
| 03752 50 625 | Ø4-16 | 70 | 5 |

03751 50 012

Coaxial Cable Stripper



| CODE | SIZE | g | |
|--------------|-------------------|----|---|
| 03751 50 012 | Dış (1) İç (2) | 20 | 5 |

03753 50 054

Mechanical Cable Stripper



| CODE | SIZE | g | |
|--------------|-------|-----|---|
| 03753 50 054 | 0.2/6 | 100 | 5 |

03753 50 026

Mechanical Cable Stripper



| CODE | SIZE | g | |
|--------------|-------|-----|---|
| 03753 50 026 | 0.2/6 | 105 | 5 |

05881

Chrom Steel Case, Measuring tapes



| CODE | SIZE M | g | |
|--------------|--------|-----|---|
| 05881 50 013 | 3 | 160 | 5 |
| 05881 50 015 | 5 | 220 | 5 |

05881

Plastic Steel Case, Measuring tapes



| CODE | SIZE M | g | |
|--------------|--------|-----|---|
| 05881 50 003 | 3 | 145 | 5 |
| 05881 50 005 | 5 | 200 | 5 |

05886

Fiberglass Measuring Tape Field Type (With Holder)



| CODE | SIZE M | g | □ |
|--------------|--------|-----|---|
| 05886 50 020 | 20 | 520 | 1 |
| 05886 50 030 | 30 | 585 | 1 |
| 05886 50 050 | 50 | 820 | 1 |

05880

Straight Level



Aluminyum body

| CODE | L mm | g | □ |
|--------------|------|-----|---|
| 05880 50 040 | 400 | 250 | 5 |
| 05880 50 050 | 500 | 300 | 5 |
| 05880 50 060 | 600 | 350 | 5 |
| 05880 50 070 | 700 | 400 | 5 |
| 05880 50 080 | 800 | 450 | 5 |
| 05880 50 100 | 1000 | 500 | 5 |
| 05880 50 120 | 1200 | 550 | 5 |
| 05880 50 150 | 1500 | 600 | 5 |
| 05880 50 200 | 2000 | 800 | 5 |

05887 50 150

Vernier



Sliding and with stop

| CODE | L mm | g | □ |
|--------------|------|-----|---|
| 05887 50 150 | 150 | 155 | 5 |

05890 50 830

Hacksaw Frame



Spare parts page 230

| CODE | L mm | g | □ |
|--------------|------|-----|---|
| 05890 50 830 | 300 | 540 | 5 |

6735 27 0300

Pruning Saw



Spare parts page 230

| CODE | L mm | g | □ |
|--------------|------|-----|---|
| 6735 27 0300 | 300 | 400 | 5 |

14000 004238

Foldable Pruning Saw



| CODE | L mm | g | □ |
|--------------|------|-----|---|
| 14000 004238 | 120 | 155 | 5 |

05901 50 020

Feeler Gauges (20 Pcs, mm)



| CODE | SIZE mm | g | □ |
|--------------|----------|----|----|
| 05901 50 020 | 0.05 - 1 | 90 | 10 |

6195 26 0260

Riveting Pliers



| CODE | SIZE | CAPACITY mm | g | □ |
|--------------|------|-------------------|-----|---|
| 6195 26 0260 | 260 | 2 - 2.5 - 3 - 3.2 | 625 | 1 |

05902 50 020

Feeler Gauges (20 Pcs, SAE)



| CODE | SIZE inch | g | □ |
|--------------|--------------|----|----|
| 05902 50 020 | 2 - 35/1000" | 65 | 10 |

6220

Flexible Magnet Holder

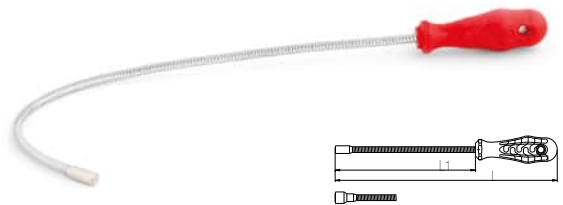

| CODE | g | L mm | L1 mm | g | □ |
|--------------|------|------|-------|-----|----|
| 6220 26 0500 | 500 | 465 | 375 | 100 | 10 |
| 6220 26 1000 | 1000 | 465 | 375 | 105 | 10 |

6225

Oiler With Flexible Spout



| CODE | SIZE cc | g | □ |
|--------------|---------|-----|---|
| 6225 26 0200 | 200 | 170 | 5 |
| 6225 26 0300 | 300 | 200 | 5 |
| 6225 26 0500 | 500 | 225 | 5 |

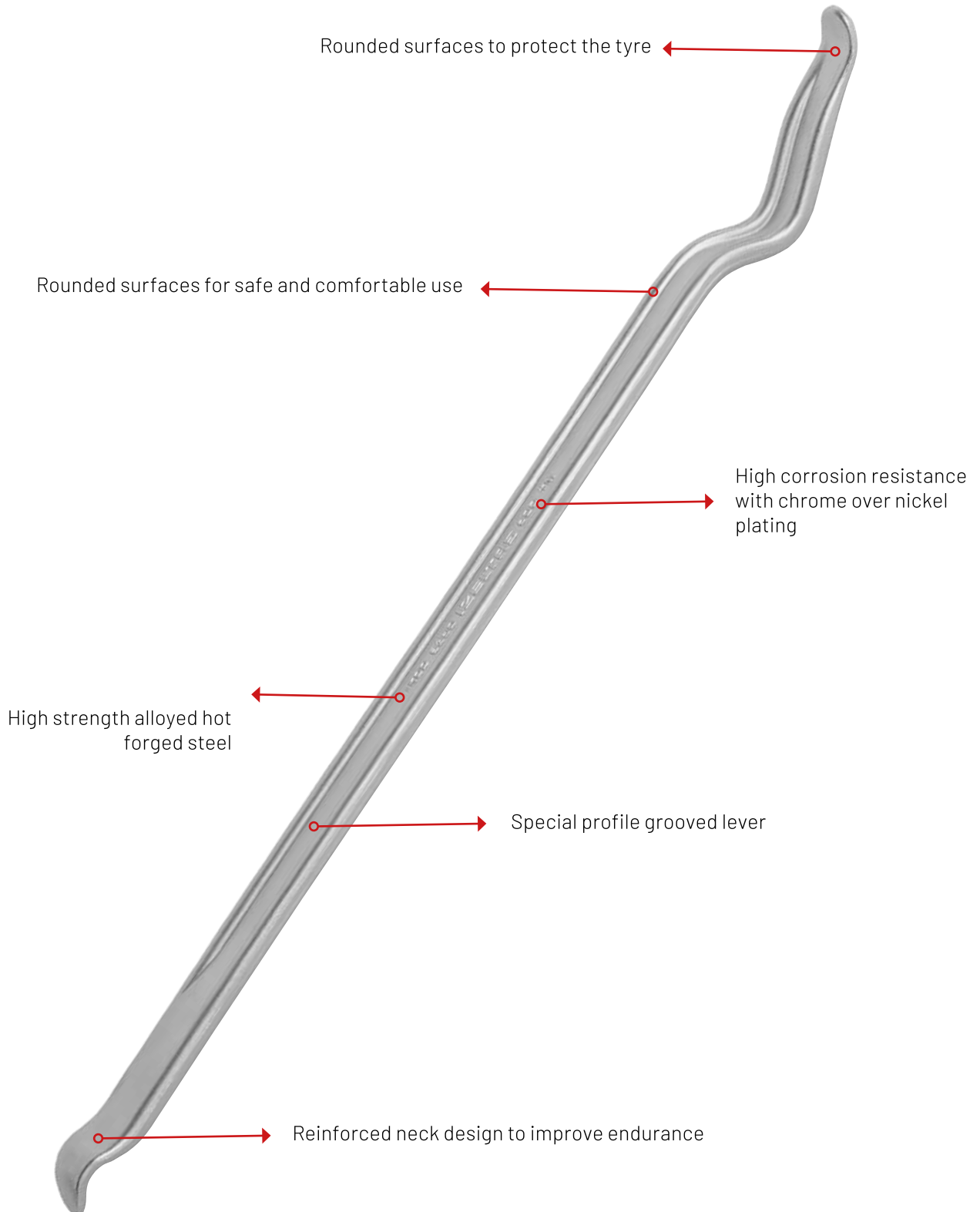

6230

Grease Gun



Spare parts page 230

| CODE | SIZE cc | g | |
|--------------|------------|-------|---|
| 6230 26 0300 | 300 | 1200 | 1 |
| 6230 26 0500 | 500 | 1320 | 1 |

6240 26 0810

Offset Wrench For Carter Case



Chrom vanadium, Chrom plated

| CODE | mm | g | |
|--------------|------|-------|----|
| 6240 26 0810 | 8x10 | 250 | 10 |

6350

Tyre Lever, Straight



Chrom vanadium, Chrom plated

| CODE | L mm | L inch | g | |
|--------------|---------|-----------|-------|---|
| 6350 26 0300 | 300 | 12" | 265 | 5 |
| 6350 26 0400 | 400 | 16" | 440 | 5 |
| 6350 26 0500 | 500 | 20" | 675 | 5 |
| 6350 26 0600 | 600 | 24" | 900 | 5 |

6360 26 0600

Tyre Lever, Bent



Chrom vanadium, Chrom plated

| CODE | L mm | L inch | g | |
|--------------|---------|-----------|-------|---|
| 6360 26 0600 | 600 | 24" | 910 | 5 |

6370 26 0100

Band Type Oil Filter Wrench



| CODE | σ mm | g | |
|--------------|----------|-------|---|
| 6370 26 0100 | 75 - 100 | 335 | 5 |



6375 26 6512

06374 50 140

Left and Right Hand Operation, Triple Leg Oil Filter Wrench

Chain Wrench



3/8" - 1/2"

| CODE | Ø mm | g | □ |
|--------------|--------|-----|---|
| 6375 26 6512 | 75-120 | 605 | 5 |

| CODE | Ø mm | g | □ |
|--------------|--------|-----|---|
| 06374 50 140 | 60x140 | 390 | 5 |

6380 26 6016

Oil Filter Wrench With Double Chain



| CODE | Ø mm | g | □ |
|--------------|--------|-----|---|
| 6380 26 6016 | 60-160 | 380 | 5 |

06373 50 140

06375 50 100

Strap Wrench

Adjustable Slot Type Oil Filter Wrench



| CODE | Ø mm | g | □ |
|--------------|--------|-----|---|
| 06373 50 140 | 60x140 | 245 | 5 |

Spare parts page 229

| CODE | Ø mm | g | □ |
|--------------|--------|-----|---|
| 06375 50 100 | 65-110 | 215 | 5 |

06390

Piston Ring Compressor



| CODE | Ø mm | g | |
|--------------|------|-----|---|
| 06390 50 125 | 125 | 235 | 5 |
| 06390 50 175 | 175 | 505 | 5 |

07410 50 010

Extension Cord Reel (With Handle)

 Cable \varnothing 3x1.5 mm

| CODE | MODEL | SIZE | g | |
|--------------|-------------|------|------|---|
| 07410 50 010 | with handle | 10 | 1400 | 1 |

07415

Hand Brush (Wooden Handle)



| CODE | SIZE | g | |
|--------------|---------------|-----|---|
| 07415 50 003 | 3 SIRA 3 RAWS | 125 | 5 |
| 07415 50 004 | 4 SIRA 4 RAWS | 135 | 5 |
| 07415 50 005 | 5 SIRA 5 RAWS | 145 | 5 |
| 07415 50 006 | 6 SIRA 6 RAWS | 170 | 5 |

07410

Extension Cord Reel (With Stand)

[Spare parts page 228](#)

 Cable \varnothing 3x1.5 mm

| CODE | MODEL | SIZE | g | |
|--------------|------------|------|------|---|
| 07410 50 025 | with stand | 25 | 4130 | 1 |
| 07410 50 050 | with stand | 50 | 6745 | 1 |

07416 50 001

Hand Brush (PP Handle)



| CODE | L mm | g | |
|--------------|------|-----|---|
| 07416 50 001 | 270 | 110 | 5 |



FORGED STEEL VICE WITH SWIVEL BASE

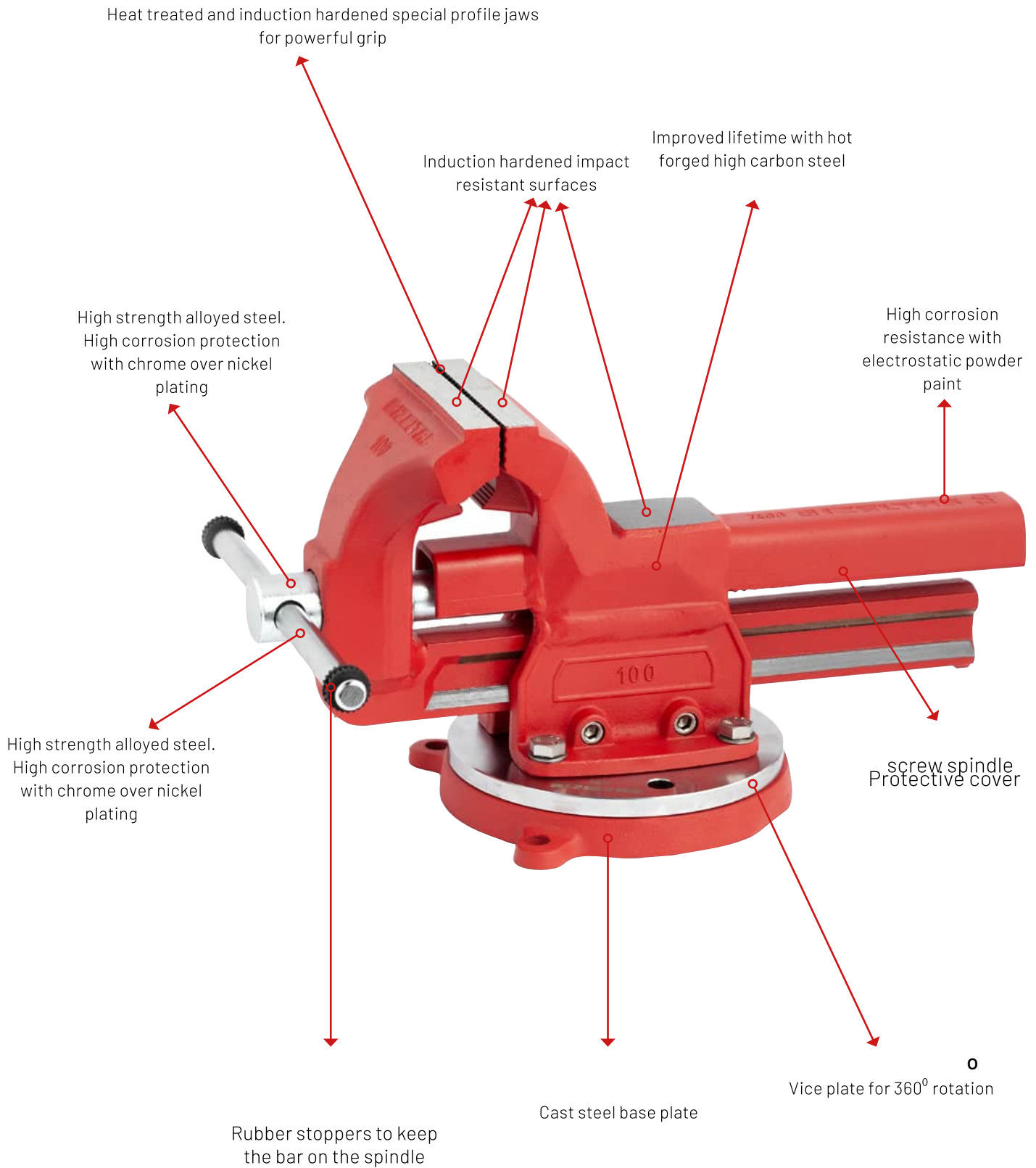

7401

7400

Swivel Base of Vice

Forged Steel Vice

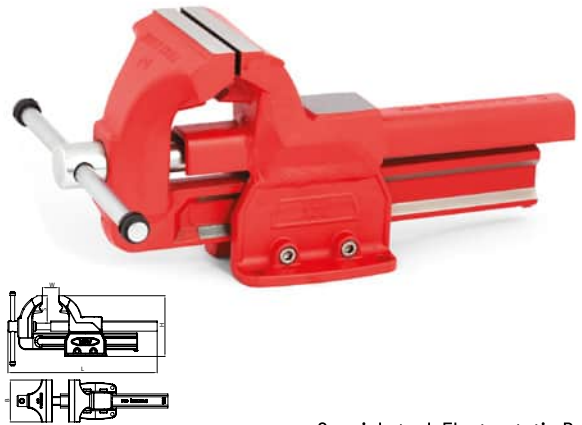
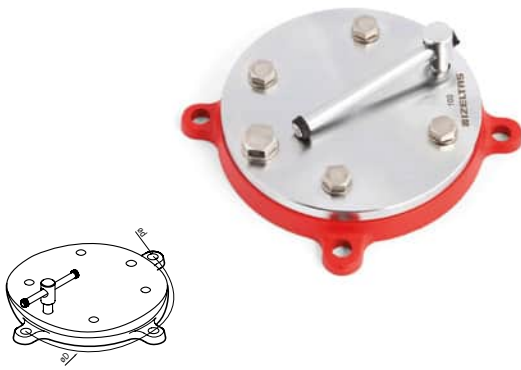

Special steel, Chrom plated

Special steel, Electrostatic Paint

| CODE | SIZE | σd mm | σD mm | g | |
|--------------|------|------------------|------------------|------|---|
| 7401 30 0100 | 100 | 10.5 | 160 | 1550 | 1 |
| 7401 30 0125 | 125 | 12.5 | 200 | 2700 | 1 |
| 7401 30 0150 | 150 | 12.5 | 240 | 3800 | 1 |
| 7401 30 0175 | 175 | 12.5 | 280 | 6650 | 1 |

| CODE | B mm | W mm | H mm | L mm | g | |
|--------------|---------|---------|---------|---------|-------|---|
| 7400 30 0100 | 100 | 125 | 148 | 440 | 5000 | 1 |
| 7400 30 0125 | 125 | 155 | 183 | 550 | 11000 | 1 |
| 7400 30 0150 | 150 | 180 | 220 | 675 | 20000 | 1 |
| 7400 30 0175 | 175 | 205 | 245 | 760 | 29000 | 1 |

7400

Forged Steel Vice with Swivel Base



Special steel, Electrostatic Paint

| CODE | B mm | g | |
|--------------|---------|-------|---|
| 7400 00 0100 | 100 | 6550 | 1 |
| 7400 00 0125 | 125 | 13700 | 1 |
| 7400 00 0150 | 150 | 23800 | 1 |
| 7400 00 0175 | 175 | 35650 | 1 |

Machinist Forged Steel Vise

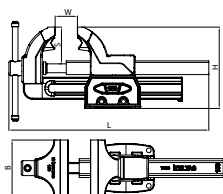

Special steel, Electrostatic Paint

| CODE | B mm | W mm | H mm | L mm | g | □ |
|--------------|------|------|------|------|-------|---|
| 14000 005070 | 100 | 125 | 120 | 308 | 5200 | 1 |
| 14000 005069 | 125 | 160 | 140 | 388 | 9300 | 1 |
| 14000 005072 | 150 | 190 | 190 | 480 | 18500 | 1 |
| 14000 005071 | 175 | 205 | 200 | 520 | 25000 | 1 |

Swivel Base Of Machinist Vise

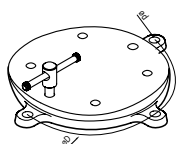

Special steel, Electrostatic Paint



| CODE | SIZE | σd mm | σD mm | g | □ |
|--------------|------|---------------|---------------|------|---|
| 14000 005126 | 100 | 11.5 | 150 | 800 | 1 |
| 14000 005127 | 125 | 13.5 | 185 | 1300 | 1 |
| 14000 005128 | 150 | 16 | 225 | 2000 | 1 |
| 14000 005129 | 175 | 17.5 | 250 | 2600 | 1 |

7300

Carpenter Screw Clamp



Impact resistant cast iron jaws



| CODE |  | a mm | b mm |  g |  |
|--------------|--|------|------|--|--|
| 7300 30 3012 | 30x12 | 300 | 120 | 1605 | 5 |
| 7300 30 4012 | 40x12 | 400 | 120 | 1780 | 5 |
| 7300 30 5012 | 50x12 | 500 | 120 | 1935 | 5 |
| 7300 30 6012 | 60x12 | 600 | 120 | 2080 | 5 |
| 7300 30 8012 | 80x12 | 800 | 120 | 2470 | 5 |
| 7300 30 1012 | 100x12 | 1000 | 120 | 2790 | 5 |

7310

Mini Clamp



Alloyed aluminum jaws

| CODE |  | a mm | b mm |  g |  |
|--------------|---|------|------|--|--|
| 7310 30 1005 | 10x5 | 100 | 50 | 250 | 5 |
| 7310 30 1505 | 15x5 | 150 | 50 | 280 | 5 |
| 7310 30 2005 | 20x5 | 200 | 50 | 310 | 5 |
| 7310 30 2505 | 25x5 | 250 | 50 | 330 | 5 |
| 7310 30 3005 | 30x5 | 300 | 50 | 360 | 5 |

14000 004293

Mechanics Creeper (Big) 40"



| SIZE | SIZE (mm) | Low Profile |  |
|--------------|-----------|-------------|---|
| 14000 004293 | 500x1010 | 65 mm | 1 |

14000 004294

Mechanics Creeper (Small) 36"



| CODE | SIZE (mm) | Low Profile |  |
|--------------|-----------|-------------|---|
| 14000 004294 | 400x900 | 65 mm | 1 |



- The utility knife blade should be used with the handle attached to the body. Using only the blade can result in serious injuries.
- When placing the utility knife in tool cabinets and tool bags, make sure that the blade is closed.
- The utility knife should not be stored in wet, humid, or oily environments.
- Worn or broken blades of the utility knife should not be used. They should be discarded in a separate box after breakage and replaced with a new cutting edge.
- When breaking a dull or worn blade of the utility knife from the marked areas, it should be held tightly between the jaws of pliers, etc., to prevent harm to the body.
- Utility knives with damaged bodies or faulty locking mechanisms should not be used.



- Utility knife blade should be kept in the closed position inside the handle when not in use.
- During the use of the utility knife, the material being cut should be secured or placed on a flat surface to ensure safe and careful cutting.
- The cutting direction during the use of the utility knife should be away from our body.
- During the use of the utility knife, we should keep our hands and body away from the cutting area according to the piece being cut.
- The cutting edge of the utility knife should be angled based on the material to be cut. Opening the edge too much can cause breakage.
- Using the utility knife for purposes other than its intended use can lead to accidents (e.g., As a screwdriver, scraper, or chisel).
- During the use of the utility knife, protective gloves and safety glasses should be worn.
- The appropriate utility knife should be chosen according to the type of cutting work to be done.



UTILITY KNIVES

Utility Knives

Utility Knives Spare Blades



Pro Safety Auto- Locking Utility Knife



- Auto-Lock Mechanism
- Metal-Bodied
- Rubber Coated
- Ergonomic Design
- Trapeze Knife
- 2 Spare Blades
- Auto Safety Button
- Hanging Hole

| CODE | L mm | g | |
|--------------|---------|-----|----|
| 14000 005051 | 175 | 205 | 12 |

Pro Safety Metal-Bodied Auto-Locking Utility Knife 18 mm



- Auto-Lock Mechanism
- Metal-Bodied
- Rubber Coated
- Ergonomic Design
- 18 mm Blade Width
- Knife Breaking Part
- Safety Cutting
- Hanging Hole

| CODE | L mm | g | |
|--------------|---------|-----|----|
| 14000 005050 | 195 | 175 | 12 |

14000 005049

Pro Metal-Bodied Utility Knife 18 mm



Auto-Lock Mechanism
Metal-Bodied
Rubber Coated
Ergonomic Design
18 mm Blade Width
Knife Breaking Part
Hanging Hole

| CODE | L mm |  |  |
|--------------|---------|---|---|
| 14000 005049 | 172 | 85 | 12 |

14000 00 5047

Pro Metal-Bodied Auto-Loading Utility Knife 9 mm



Auto-Lock Mechanism
Metal-Bodied
Rubber Coated
Ergonomic Design
9 mm Blade Width
Auto Loading
Hanging Hole
5 Spare Blades

| CODE | L mm |  |  |
|--------------|---------|---|---|
| 14000 005047 | 136 | 80 | 12 |

14000 005053

Pro Metal-Bodied Utility Knife 30° Angled 9 mm



| CODE | L mm | g | □ |
|--------------|---------|----|----|
| 14000 005053 | 134 | 15 | 24 |

14000 005052

Pro Metal-Bodied Utility Knife 9 mm



Auto-Lock Mechanism
Metal-bodied
9 mm Blade Width
Rubber Coated
Ergonomic Design
Hanging Hole

| CODE | L mm | g | □ |
|--------------|---------|----|----|
| 14000 005052 | 130 | 50 | 12 |

14000 005048

Pro Safety Metal Bodied Auto-Locking Utility Knife 9 mm



Auto-Lock Mechanism
Metal-bodied
9 mm Blade Width
Rubber Coated
Ergonomic Design
Safety Cutting
Hanging Hole

| CODE | L mm | g | □ |
|--------------|---------|----|----|
| 14000 005048 | 162 | 75 | 12 |

14000 005090

Pro Safety Utility Knife Spare Blade 18 mm



One Package Contains 10 Blades, One Box Contains 24 Packages

| CODE | SIZE (mm) | □ |
|--------------|--------------|----|
| 14000 005090 | 18 | 24 |

14000 005088

Pro Utility Knife Spare Blade 18 mm



One Package Contains 10 Blades, One Box Contains 24 Packages

| CODE | SIZE (mm) | □ |
|--------------|--------------|----|
| 14000 005088 | 18 | 24 |

14000 005089

Pro Utility Knife Spare Blade 9 mm



One Package Contains 10 Blades, One Box Contains 24 Packages

| CODE | SIZE (mm) | □ |
|--------------|--------------|----|
| 14000 005089 | 9 | 24 |

14000 005091

Pro Utility Knife Spare Blade 30° 9 mm



One Package Contains 10 Blades, One Box Contains 24 Packages

| CODE | SIZE (mm) | □ |
|--------------|--------------|----|
| 14000 005091 | 9 | 24 |

SHEARS

Bolt Cutters

Sheet Metal Cutters

Plastic Pipe Cutters

Pruning Shears



Heat-treated and induction hardened cutting edges for long lifetime

PVC coated handle

Locking latch to keep the arms closed

Long life spring

Black finish

High carbon hot forged steel for improved performance

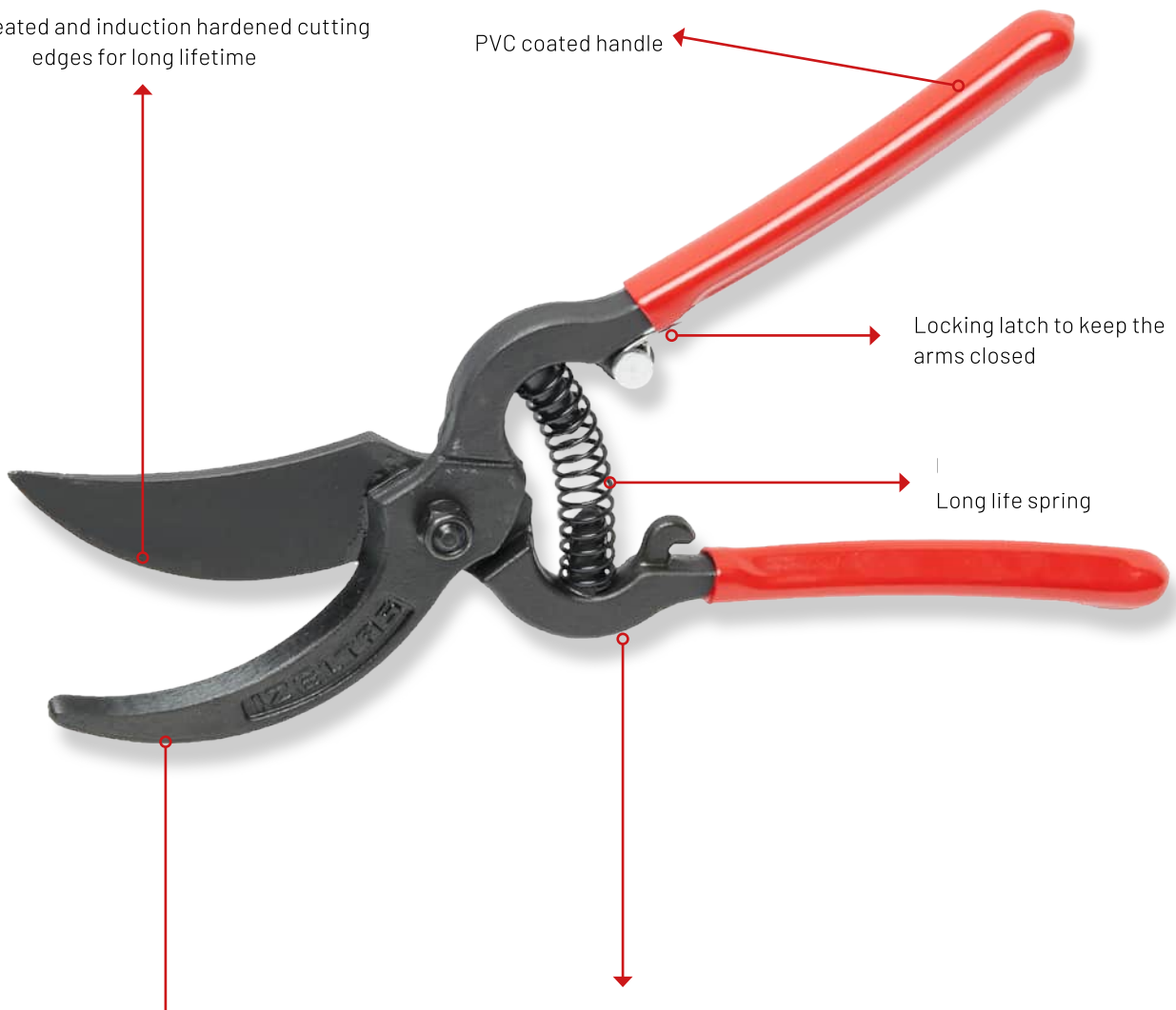

IZELTAS YOUTUBE

2350

Bolt Cutters



Spare parts page 228

Special steel, Cutters induction hardened,
Electrostatically painted jaws and connection parts drop forged

| CODE | L mm | L inch | CAPACITY ø mm | g | |
|--------------|------|--------|------------------|------|---|
| 2350 27 0018 | 450 | 18" | 6 - 8 | 1510 | 1 |
| 2350 27 0024 | 600 | 24" | 8 - 10 | 2350 | 1 |
| 2350 27 0030 | 750 | 30" | 9 - 13 | 3750 | 1 |
| 2350 27 0036 | 900 | 36" | 11 - 16 | 5500 | 1 |

2350 00 6104

Bolt Cutters Frame



| CODE | CONTENTS | g | |
|--------------|--|--------|---|
| 2350 00 6104 | 18"(450) - 24"(600) 30"(750) - 36"(900) | 21.110 | 4 |

6205 27 0240

Snip For Aluminum and Metal Sheet (Right)



Special steel, Cutters induction hardened,

| CODE | L mm | L inch | g | |
|--------------|------|--------|-----|---|
| 6205 27 0240 | 240 | 10" | 380 | 5 |

6206 27 0240

Snip For Aluminum and Metal Sheet (Left)



Special steel, Cutters induction hardened

| CODE | L mm | L inch | g | |
|--------------|------|--------|-----|---|
| 6206 27 0240 | 240 | 10" | 380 | 5 |

6207 27 0240

Snip For Aluminum and Metal Sheet (Flat)



Special steel, Cutters induction hardened

| CODE | L mm | L inch | g | |
|--------------|------|--------|-----|---|
| 6207 27 0240 | 240 | 10" | 380 | 5 |

13000 001851

Aluminum and Metal Sheet Set (3 Pcs)



| CODE | L mm | L inch | g | |
|--------------|------|--------|-----|---|
| 13000 001851 | 240 | 10" | 380 | 5 |

6210

Punch Snip (Right)

DIN 6438



Special steel, Cutters induction hardened, PVC insulated

| CODE | L mm | L inch | g | |
|--------------|------|--------|-----|---|
| 6210 27 0250 | 250 | 10" | 555 | 5 |
| 6210 27 0275 | 275 | 11" | 600 | 5 |
| 6210 27 0300 | 300 | 12" | 640 | 5 |

6820

Tinman's Snip

TSEK



Special steel, Cutters induction hardened, PVC insulated

| CODE | L mm | L inch | g | |
|--------------|------|--------|-----|---|
| 6820 27 0200 | 200 | 8" | 320 | 5 |
| 6820 27 0250 | 250 | 10" | 575 | 5 |
| 6820 27 0300 | 300 | 12" | 870 | 5 |

6211

Punch Snip (Left)

DIN 6438



Special steel, Cutters induction hardened, PVC insulated

| CODE | L mm | L inch | g | |
|--------------|------|--------|-----|---|
| 6211 27 0250 | 250 | 10" | 535 | 5 |
| 6211 27 0275 | 275 | 11" | 605 | 5 |
| 6211 27 0300 | 300 | 12" | 665 | 5 |

6821

Tinman's Snip (With Spring)

TSEK



Special steel, Cutters induction hardened, PVC insulated

| CODE | L mm | L inch | g | |
|--------------|------|--------|-----|---|
| 6821 27 0250 | 250 | 10" | 575 | 5 |
| 6821 27 0300 | 300 | 12" | 895 | 5 |

6800 27 0180

Jeweller's Snip (Straight)

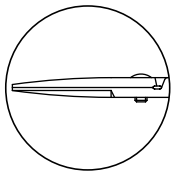

| CODE | L mm | L inch | g |
|--------------|------|--------|-----|
| 6800 27 0180 | 180 | 7 1/8" | 140 |

6801 27 0180

Jeweller's Snip (Curved)

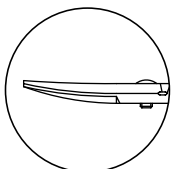

| CODE | L mm | L inch | g | |
|--------------|------|--------|-----|---|
| 6801 27 0180 | 180 | 7 1/8" | 140 | 5 |

6815 27 0200

Bolt Cutters



| CODE | L mm | L inch | g | |
|--------------|------|--------|-----|---|
| 6815 27 0200 | 200 | 8" | 295 | 5 |

13000 005122

Forging Bolt Cutters



Special steel, Cutters induction hardened, PVC insulated

| CODE | L mm | L inch | g | |
|--------------|------|--------|-----|---|
| 13000 005122 | 210 | 7 1/8" | 345 | 5 |

6740

Multi Purpose Scissors



| CODE | L mm | L inch | g | |
|--------------|------|--------|-----|---|
| 6740 27 0140 | 140 | 5 1/2" | 60 | 5 |
| 6740 27 0190 | 190 | 7 1/2" | 120 | 5 |



6710 27 0230

Pruning Shears (Lux)



İZELTAS YOUTUBE

Special steel, Cutters induction hardened, PVC insulated

| CODE | L mm | L inch | g | □ |
|--------------|------|--------|-----|---|
| 6710 27 0230 | 230 | 9" | 290 | 5 |

6715 27 0225

Pruning Shears (Comfort)



Special steel, PVC insulated

| CODE | L mm | L inch | g | □ |
|--------------|------|--------|-----|---|
| 6715 27 0225 | 225 | 9" | 340 | 5 |

6720 27 0220

Pruning Shears (Light)



Aluminum forged body, PVC insulated

| CODE | L mm | L inch | g | □ |
|--------------|------|--------|-----|---|
| 6720 27 0220 | 220 | 8 5/8" | 265 | 5 |

6712 27 0210

Pruning Shears (Fruit)



Special steel, Cutters induction hardened, PVC insulated

| CODE | L mm | L inch | g | □ |
|--------------|------|--------|-----|---|
| 6712 27 0210 | 200 | 8" | 260 | 5 |

14000 005137

Anvil Pruning Shears



Aluminum forged body, PVC insulated

| CODE | L mm | L inch | g | □ |
|--------------|---------|-----------|-----|---|
| 14000 005137 | 210 | 8 1/4" | 250 | 5 |

14000 005136

Pruning Shears (Aluminum-Bodied)



Aluminum forged body

| CODE | L mm | L inch | g | □ |
|--------------|---------|-----------|-----|---|
| 14000 005136 | 220 | 8 5/8" | 315 | 5 |

14000 005138

Stainless Steel Straight-Edge Harvesting Shears



Stainless Steel

| CODE | L mm | L inch | g | □ |
|--------------|---------|-----------|----|---|
| 14000 005138 | 190 | 7 1/2" | 85 | 5 |



06760

Plastic Pipe Cutter



Spare parts page 230

| CODE | Ø mm | g | |
|--------------|------|-----|---|
| 06760 50 042 | 42 | 400 | 5 |
| 06760 50 063 | 63 | 610 | 5 |

6850 28 0322

Mini Tube Cutter (For Copper and Aluminum)



Spare parts page 230

| CODE | SIZE | g | |
|--------------|-------------|-----|---|
| 6850 28 0322 | 1/8" - 5/8" | 120 | 1 |

6855 28 0330

Standard Tube Cutter (For Copper and Aluminum)



Spare parts page 228

| CODE | SIZE | g | | € |
|--------------|---------------|-----|---|---|
| 6855 28 0330 | 1/8" - 1 1/8" | 305 | 1 | |

6860 28 0635

Telescopic Tube Cutter (For Copper and Aluminum)



Spare parts page 230

| CODE | SIZE | g | |
|--------------|---------------|-----|---|
| 6860 28 0635 | 1/8" - 1 3/8" | 470 | 1 |

6865 28 1050

Professional Tube Cutter (For Steel)



Spare parts page 230

| CODE | SIZE | g | |
|--------------|-----------|------|---|
| 6865 28 1050 | 1/8" - 2" | 2380 | 1 |



PULLERS

Pullers

Inside Pullers

Balljoint Pullers

Stud Inserters and Removers



STANDARD PULLER TWO ARMS

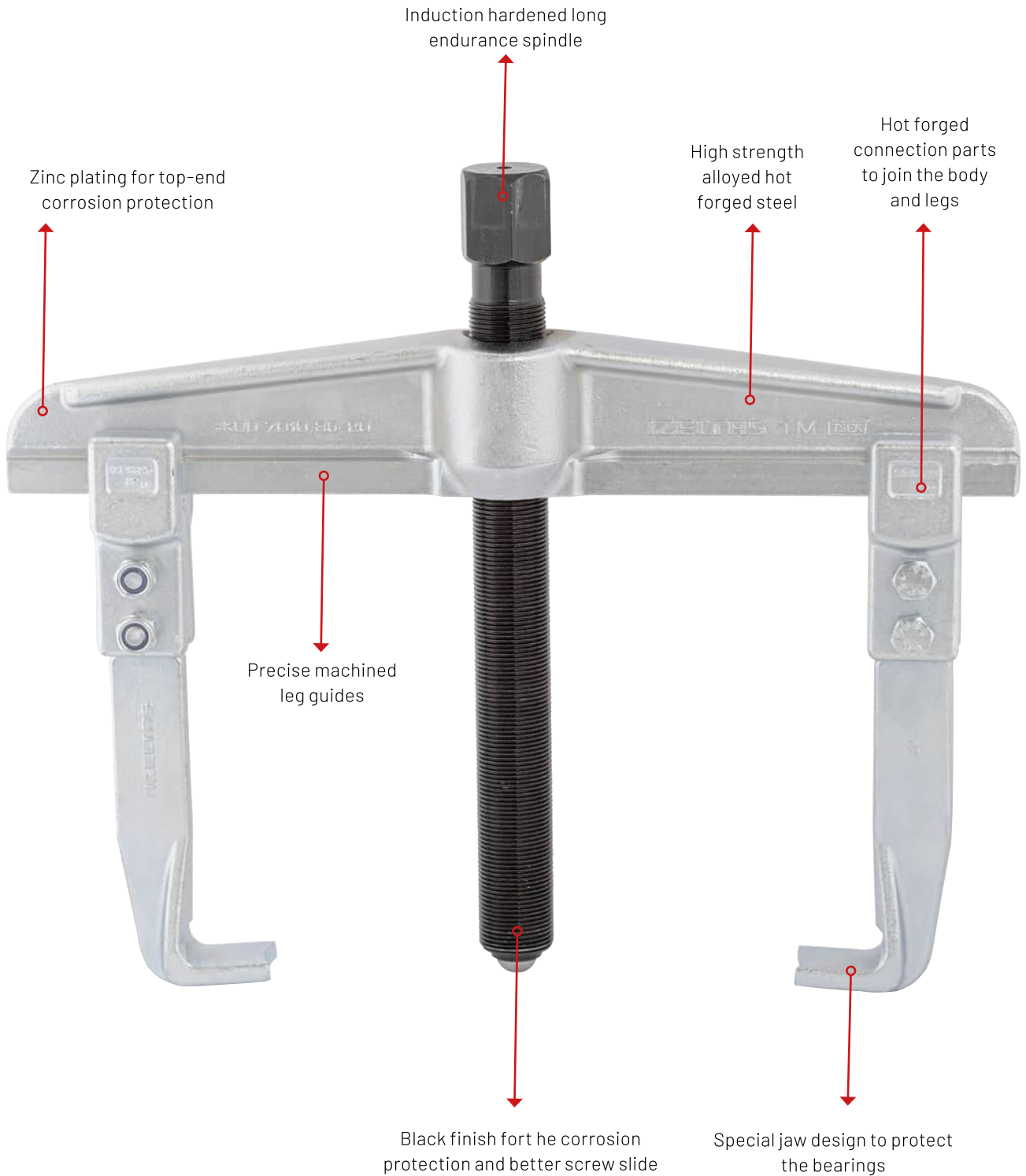

7010

TSEK

Standard Puller (Two Arms)

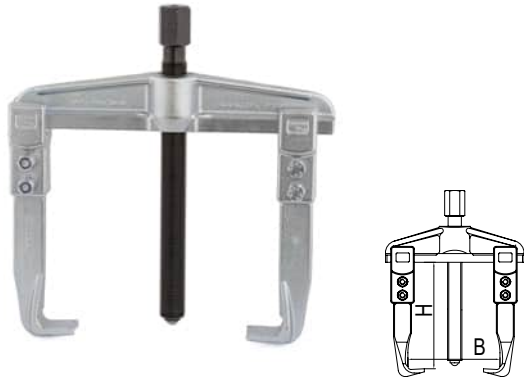

Spare parts page 231

Chrom vanadium, Zinc plated,
Arms hardened, Spindle induction hardened

| CODE | | B mm | H mm | g | |
|--------------|-------|------|------|-------|---|
| 7010 29 0810 | 8x10 | 80 | 100 | 1080 | 1 |
| 7010 29 1210 | 12x10 | 120 | 100 | 1235 | 1 |
| 7010 29 1615 | 16x15 | 160 | 150 | 2850 | 1 |
| 7010 29 2015 | 20x15 | 200 | 150 | 3060 | 1 |
| 7010 29 2520 | 25x20 | 250 | 200 | 7450 | 1 |
| 7010 29 3520 | 35x20 | 350 | 200 | 10000 | 1 |
| 7010 29 5220 | 52x20 | 520 | 200 | 14100 | 1 |

7010 00 6105

Display Frame For Pullers



| CODE | CONTENTS | g | |
|--------------|---------------------------------------|-------|---|
| 7010 00 6105 | 8x10 - 12x10 - 16x15 20x15 - 25x20 | 17840 | 5 |

7020

TSEK

Standart Puller (Three Arms)

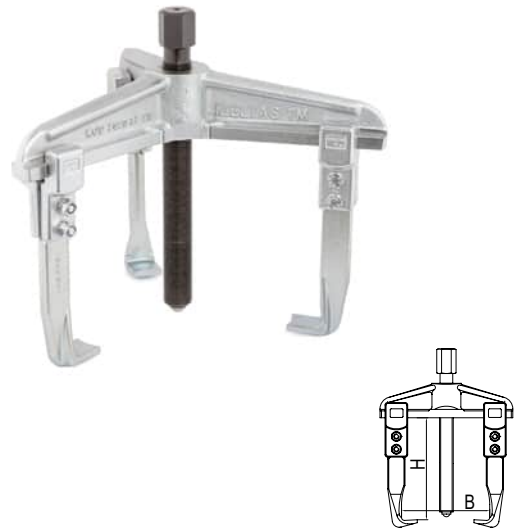

Spare parts page 231

Chrom vanadium, Zinc plated,
Arms hardened, Spindle induction hardened

| CODE | | B mm | H mm | g | |
|--------------|-------|------|------|-------|---|
| 7020 29 3720 | 37x20 | 370 | 200 | 14750 | 1 |
| 7020 29 5220 | 52x20 | 520 | 200 | 20000 | 1 |

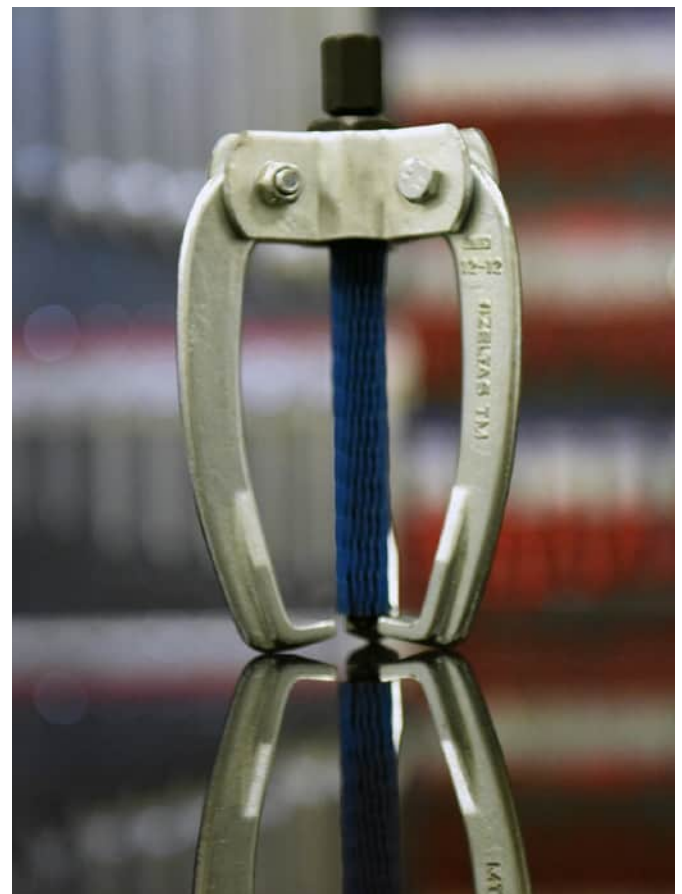

7030

Master Puller (Two Arms)



Spare parts page 231

Chrom vanadium, Zinc plated,
Arms hardened, Spindle induction hardened

| CODE | | B mm | H mm | g | |
|--------------|-------|------|------|------|---|
| 7030 29 0808 | 8x8 | 80 | 80 | 545 | 1 |
| 7030 29 1212 | 12x12 | 120 | 120 | 1075 | 1 |
| 7030 29 1616 | 16x16 | 160 | 160 | 1885 | 1 |
| 7030 29 2320 | 23x20 | 230 | 200 | 3240 | 1 |

7040

Master Puller (Three Arms)



Spare parts page 231

Chrom vanadium, Zinc plated,
Arms hardened, Spindle induction hardened

| CODE | | B mm | H mm | g | |
|--------------|-------|------|------|------|---|
| 7040 29 0808 | 8x8 | 80 | 80 | 680 | 1 |
| 7040 29 1212 | 12x12 | 120 | 120 | 1355 | 1 |
| 7040 29 1616 | 16x16 | 160 | 160 | 2320 | 1 |
| 7040 29 2320 | 23x20 | 230 | 200 | 4025 | 1 |

7050

Battery Puller (Two Arms)



Spare parts page 231

Chrom vanadium, Zinc plated,
Arms hardened, Spindle induction hardened

| CODE | | B mm | H mm | g |
|--------------|-----|------|------|-----|
| 7050 29 0604 | 6x4 | 60 | 40 | 245 |
| 7050 29 0606 | 6x6 | 60 | 60 | 275 |
| 7050 29 0808 | 8x8 | 80 | 80 | 555 |

7060

Battery Puller (Three Arms)



Spare parts page 231

Chrom vanadium, Zinc plated,
Arms hardened, Spindle induction hardened

| CODE | | B mm | H mm | g | |
|--------------|-----|------|------|-----|---|
| 7060 29 0604 | 6x4 | 60 | 40 | 300 | 1 |
| 7060 29 0606 | 6x6 | 60 | 60 | 345 | 1 |
| 7060 29 0808 | 8x8 | 80 | 80 | 715 | 1 |

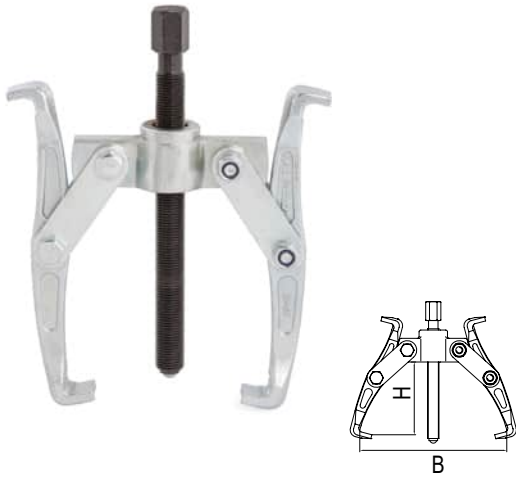
7070 29 2013
S Type Puller (Two Arms)

Spare parts page 231

 Chrom vanadium, Zinc plated,
Arms hardened, Spindle induction hardened

| CODE | | B mm | H mm | g | |
|--------------|-------|------|------|------|---|
| 7070 29 2013 | 20x13 | 200 | 130 | 2420 | 1 |

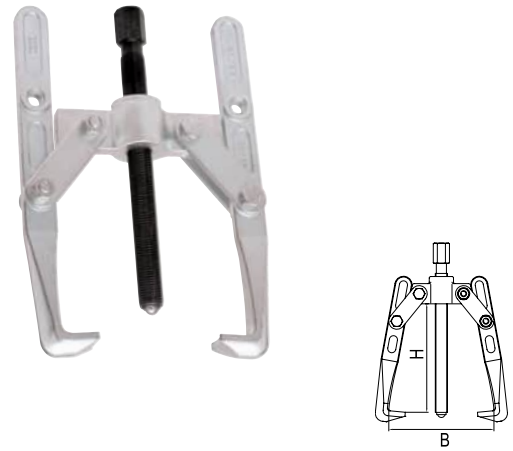
7090 29 2022
Universal Puller (Two Arms)

Spare parts page 231

 Chrom vanadium, Zinc plated,
Arms hardened, Spindle induction hardened

| CODE | | B mm | H mm | g | |
|--------------|-------|------|------|------|---|
| 7090 29 2222 | 22x22 | 220 | 220 | 3085 | 1 |

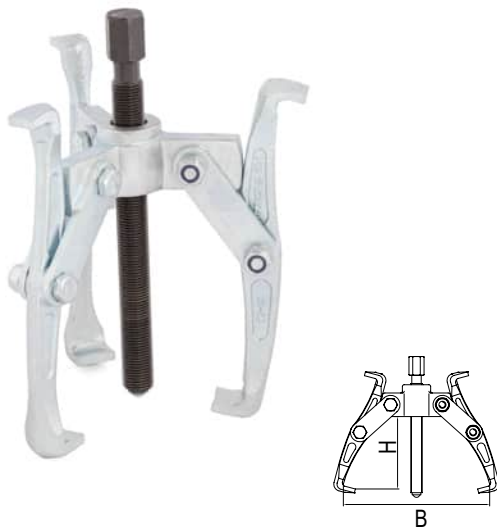
7080 29 2013
S Type Puller (Three Arms)

Spare parts page 231

 Chrom vanadium, Zinc plated,
Arms hardened, Spindle induction hardened

| CODE | | B mm | H mm | g | |
|--------------|-------|------|------|------|---|
| 7080 29 2013 | 20x13 | 200 | 130 | 3250 | 1 |

7100 29 2022
Universal Puller (Three Arms)

Spare parts page 231

 Chrom vanadium, Zinc plated,
Arms hardened, Spindle induction hardened

| CODE | | B mm | H mm | g | |
|--------------|-------|------|------|------|---|
| 7100 29 2222 | 22x22 | 220 | 220 | 4125 | 1 |

Internal Expansion Puller - Model A

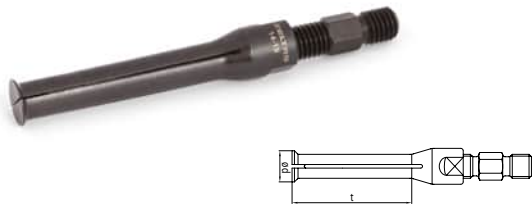

| CODE | ØD mm | t mm | Arm/ For | | g | |
|--------------|---------|------|---------------------|-----|-----|---|
| 7120 29 0507 | 5 - 7 | 30 | 35 - 75 | M10 | 40 | 1 |
| 7120 29 0709 | 7 - 9 | 30 | 35 - 75 | M10 | 40 | 1 |
| 7120 29 0912 | 9 - 12 | 30 | 35 - 75 | M10 | 40 | 1 |
| 7120 29 1013 | 10 - 13 | 30 | 35 - 75 | M10 | 40 | 1 |
| 7120 29 1317 | 13 - 17 | 50 | 35 - 75 | M10 | 60 | 1 |
| 7120 29 1419 | 14 - 19 | 60 | 35 - 75 | M10 | 75 | 1 |
| 7120 29 1621 | 16 - 21 | 60 | 35 - 75 | M10 | 75 | 1 |
| 7120 29 1823 | 18 - 23 | 60 | 35 - 75 | M10 | 100 | 1 |
| 7120 29 2025 | 20 - 25 | 60 | 35 - 75 | M10 | 100 | 1 |
| 7120 29 2530 | 25 - 30 | 60 | 35 - 75 | M10 | 110 | 1 |
| 7120 29 3037 | 30 - 37 | 70 | 35 - 75 60 - 130 | M10 | 250 | 1 |
| 7120 29 3542 | 35 - 42 | 70 | 35 - 75 60 - 130 | M10 | 250 | 1 |
| 7120 29 3845 | 38 - 45 | 70 | 35 - 75 60 - 130 | M10 | 250 | 1 |
| 7120 29 4350 | 43 - 50 | 70 | 35 - 75 60 - 130 | M10 | 400 | 1 |

7120 29 2540

Internal Expansion Puller - Model B



| CODE | ØD mm | t mm | Arm/ For | | g | |
|--------------|---------|------|---------------------|-----|-----|---|
| 7120 29 2540 | 25 - 40 | 45 | 35 - 75 60 - 130 | M10 | 235 | 1 |

Arms For Internal Expansion Puller



Chrom vanadium, Zinc plated,
Arms hardened, Spindle induction hardened

| CODE | Capacity mm | Used for | Screw Adapter | g | |
|------|-------------|----------|---------------|---|--|
|------|-------------|----------|---------------|---|--|

| | | | | | |
|--------------|---------|---|-----|-----|---|
| 7120 29 3575 | 35 - 75 | Model A 5 - 7den 43 - 50'ye Model B 25 - 40 | M10 | 625 | 1 |
|--------------|---------|---|-----|-----|---|

| | | | | | |
|--------------|----------|---|-----|------|---|
| 7120 29 6013 | 60 - 130 | Model A 30 - 37den 43 - 50'ye Model B 25 - 40 | M10 | 1000 | 1 |
|--------------|----------|---|-----|------|---|



7122

Seperator



Chrom vanadium, Zinc plated,
Arms hardened, Spindle induction hardened

| CODE | Ø mm | Arm / For | Screw Adapter | g | |
|--------------|----------|-----------|---------------|-------|---|
| 7122 29 0560 | 5 - 60 | 40 - 115 | M12 | 370 | 1 |
| 7122 29 1275 | 12 - 75 | 40 - 115 | M12 | 635 | 1 |
| 7122 29 2211 | 22 - 115 | 55 - 205 | M16 | 1780 | 1 |
| 7122 29 2515 | 25 - 155 | 90 - 260 | M20x1.5 | 3940 | 1 |
| 7122 29 3022 | 30 - 220 | 100 - 360 | M20x1.5 | 11000 | 1 |
| 7122 29 4028 | 40 - 280 | 140 - 435 | M24x3 | 15000 | 1 |

7122

Puller Arms For Separator

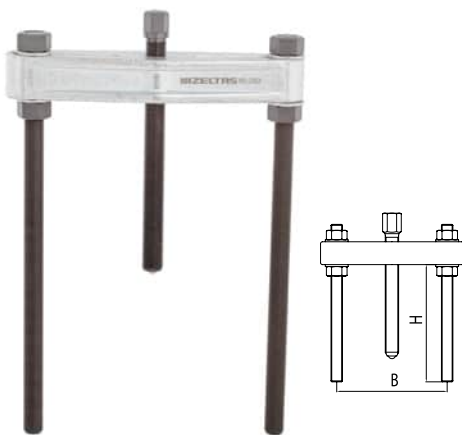

Chrom vanadium, Zinc plated,
Arms Spindle induction hardened

| CODE | B mm | H mm | Jaw / For | Screw Adapter | g | |
|--------------|---------|------|-------------------|---------------|-------|---|
| 7122 29 4011 | 40-115 | 150 | 5 - 60 12 - 75 | M12 | 990 | 1 |
| 7122 29 5520 | 55-205 | 210 | 22 - 115 | M16 | 2700 | 1 |
| 7122 29 9026 | 90-260 | 315 | 25 - 155 | M20x1.5 | 4965 | 1 |
| 7122 29 1036 | 100-360 | 305 | 30 - 220 | M20x1.5 | 7000 | 1 |
| 7122 29 1443 | 140-435 | 320 | 40 - 280 | M24x3 | 11000 | 1 |

7126

Extractor For Ball Joint

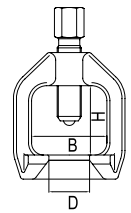

| CODE | øD mm | B mm | H mm | g | |
|--------------|-------|------|------|------|---|
| 7126 29 0018 | 18 | 40 | 40 | 315 | 1 |
| 7126 29 0025 | 25 | 50 | 50 | 540 | 1 |
| 7126 29 0029 | 29 | 60 | 60 | 915 | 1 |
| 7126 29 0040 | 40 | 80 | 80 | 1965 | 1 |
| 7126 29 0045 | 45 | 90 | 100 | 2670 | 1 |

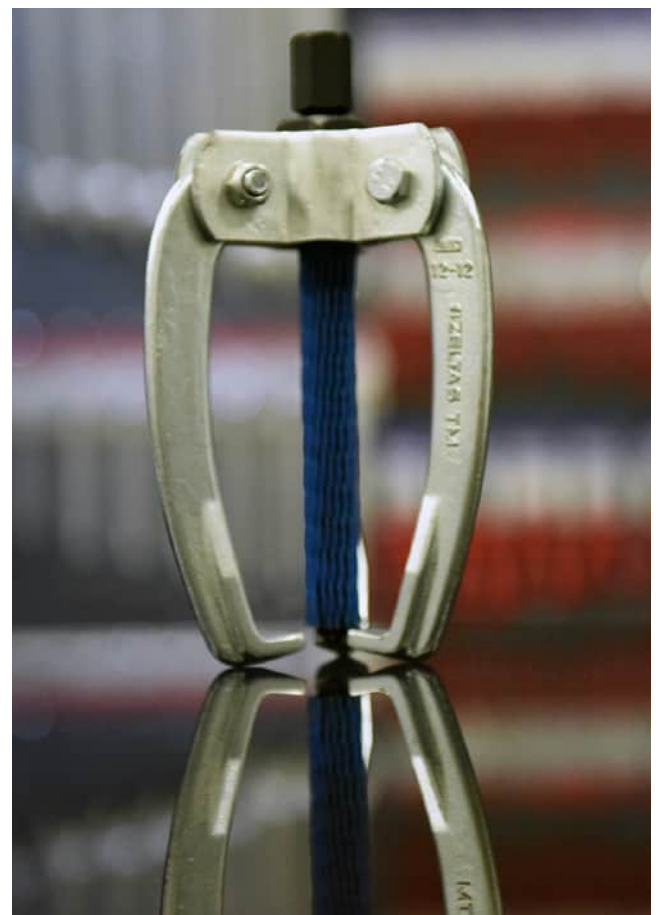



SPARE PARTS



Adjustable Wrench, Spare Parts

| | CODE | L mm | L inch | g | |
|--------|--------------|------|--------|----|----|
| Nut | 0600 01 0206 | 160 | 6" | 5 | 10 |
| | 0600 01 0208 | 208 | 8" | 10 | 10 |
| | 0600 01 0210 | 260 | 10" | 10 | 10 |
| | 0600 01 0212 | 308 | 12" | 20 | 10 |
| | 0600 01 0215 | 388 | 15" | 65 | 10 |
| Bolt | 0600 01 0306 | 160 | 6" | 3 | 10 |
| | 0600 01 0308 | 208 | 8" | 5 | 10 |
| | 0600 01 0310 | 260 | 10" | 5 | 10 |
| | 0600 01 0312 | 308 | 12" | 10 | 10 |
| | 0600 01 0315 | 388 | 15" | 20 | 10 |
| Spring | 0600 01 0406 | 160 | 6" | 1 | 10 |
| | 0600 01 0408 | 208 | 8" | 1 | 10 |
| | 0600 01 0410 | 260 | 10" | 1 | 10 |
| | 0600 01 0412 | 308 | 12" | 1 | 10 |
| | 0600 01 0415 | 388 | 15" | 3 | 10 |

Stillson Wrench Spare Part

| | CODE | FOR | g | |
|--------------|-----------------|--------------|-----|----|
| Jaw | 2100 10 0108 | 8" | 80 | 5 |
| | 2100 10 0110 | 10" | 180 | 5 |
| | 2100 10 0112 | 12" | 320 | 5 |
| | 2100 10 0114 | 14" | 400 | 5 |
| | 2100 10 0118 | 18" | 575 | 5 |
| | 2100 10 0124 | 24" | 980 | 5 |
| | Connection Part | 2100 10 0208 | 8" | 60 |
| 2100 10 0210 | | 10" | 95 | 5 |
| 2100 10 0212 | | 12" | 100 | 5 |
| 2100 10 0214 | | 14" | 195 | 5 |
| 2100 10 0218 | | 18" | 345 | 5 |
| 2100 10 0224 | | 24" | 445 | 5 |
| Somun Nut | 2100 10 0308 | 8" | 10 | 5 |
| | 2100 10 0310 | 10" | 30 | 5 |
| | 2100 10 0312 | 12" | 25 | 5 |
| | 2100 10 0314 | 14" | 45 | 5 |
| | 2100 10 0318 | 18" | 75 | 5 |
| | 2100 10 0324 | 24" | 105 | 5 |

Spare Chain For Chain Pipe Wrench

| | CODE | SIZE Inch | L mm | g | |
|--|--------------|-----------|------|------|---|
| | 14000 005039 | 4" | 555 | 840 | 1 |
| | 14000 005040 | 6" | 785 | 1635 | 1 |
| | 14000 005139 | 8" | 990 | 2400 | 1 |

Pipe Wrench, Heavy Duty Spare Parts

| | CODE | FOR | g | |
|-----|--------------|-----|------|---|
| Jaw | 2110 10 0108 | 8" | 100 | 5 |
| | 2110 10 0110 | 10" | 205 | 5 |
| | 2110 10 0112 | 12" | 235 | 5 |
| | 2110 10 0114 | 14" | 400 | 5 |
| | 2110 10 0118 | 18" | 675 | 5 |
| | 2110 10 0124 | 24" | 900 | 5 |
| | 2110 10 0136 | 36" | 1820 | 5 |
| | 2110 10 0148 | 48" | 3410 | 5 |
| Nut | 2110 10 0308 | 8" | 10 | 5 |
| | 2110 10 0310 | 10" | 25 | 5 |
| | 2110 10 0312 | 12" | 35 | 5 |
| | 2110 10 0314 | 14" | 40 | 5 |
| | 2110 10 0318 | 18" | 65 | 5 |
| | 2110 10 0324 | 24" | 115 | 5 |
| | 2110 10 0336 | 36" | 230 | 5 |
| | 2110 10 0348 | 48" | 305 | 5 |

| | | | |
|--------------|-----|-----|---|
| 2110 10 0408 | 8" | 15 | 5 |
| 2110 10 0410 | 10" | 40 | 5 |
| 2110 10 0412 | 12" | 60 | 5 |
| 2110 10 0414 | 14" | 60 | 5 |
| 2110 10 0418 | 18" | 90 | 5 |
| 2110 10 0424 | 24" | 125 | 5 |
| 2110 10 0436 | 36" | 225 | 5 |
| 2110 10 0448 | 48" | 285 | 5 |

Somun

| | CODE | FOR | g | |
|-----|--------------|--------|----|----|
| Nut | 2201 10 0110 | 1" | 25 | 10 |
| | 2201 10 0115 | 1 1/2" | 40 | 10 |
| | 2201 10 0120 | 2" | 60 | 10 |
| | 2201 10 0130 | 3" | 75 | 10 |
| | 2201 10 0140 | 4" | 75 | 10 |

Bolt Cutters Spare Part

| | CODE | SIZE | CAPACITY ø mm | g | |
|-----|--------------|------|---------------|------|---|
| Jaw | 2350 27 0118 | 18" | 6 - 8 | 850 | 1 |
| | 2350 27 0124 | 24" | 8 - 10 | 870 | 1 |
| | 2350 27 0130 | 30" | 9 - 13 | 1250 | 1 |
| | 2350 27 0136 | 36" | 11 - 16 | 1850 | 1 |

5850

Plastic Hammer Spare Head



| CODE | ØD mm | g | □ |
|--------------|-------|-----|----|
| 5850 25 0130 | 30 | 35 | 10 |
| 5850 25 0140 | 40 | 70 | 10 |
| 5850 25 0150 | 50 | 120 | 10 |

6400

Adze Handle



| CODE | L mm | g | □ |
|--------------|------|-----|----|
| 6400 25 0001 | 400 | 140 | 10 |

5800

Hammer Handle (With Pin)



| CODE | L mm | g | g | □ |
|--------------|------|------|-----|----|
| 5800 25 0001 | 260 | 100 | 60 | 10 |
| 5800 25 0002 | 280 | 200 | 60 | 10 |
| 5800 25 0003 | 300 | 300 | 95 | 10 |
| 5800 25 0005 | 320 | 500 | 100 | 10 |
| 5800 25 0010 | 360 | 1000 | 165 | 10 |
| 5800 25 0015 | 380 | 1500 | 185 | 10 |
| 5800 25 0020 | 400 | 2000 | 205 | 10 |

5865

Mallet Handle (With Pin)



| CODE | L mm | g | g | □ |
|--------------|------|------|-----|----|
| 5865 25 0001 | 260 | 1000 | 210 | 10 |
| 5865 25 0002 | 280 | 1500 | 270 | 10 |

6410

Hatchet Handle (With Pin)



| CODE | L mm | g | g | □ |
|--------------|------|-----|-----|----|
| 6410 25 0001 | 380 | 800 | 250 | 10 |

03755

Cable Strippers Spare Blade



| CODE | SIZE | g | □ |
|--------------|-----------------|----|---|
| 03755 50 625 | ø 4-16 / ø 8-28 | 25 | 5 |

06375

Adjustable Slot Type Oil Filter Wrench Spare Clamp



| CODE | Ø mm | g | □ |
|--------------|------|----|---|
| 06375 50 010 | 65 | 20 | 5 |



6230

Grease Gun Nozzle



500cc
300cc

| | | | | |
|--------------|----|----|----|----|
| 6230 26 2500 | 38 | 15 | 31 | 10 |
|--------------|----|----|----|----|

Hose for Grease Gun



| CODE | ∅ mm | L mm | g | |
|--------------|------|------|-----|----|
| 6230 26 3300 | 8 | 300 | 34 | 10 |
| 6230 26 3500 | 12 | 500 | 102 | 10 |

05898

Hacksaw Blade HSS



| CODE | SIZE | g | |
|--------------|------------|----|-----|
| 05898 50 283 | 13x0.65x18 | 20 | 100 |

05899

Hacksaw Blade Bimetal



| CODE | SIZE | g | |
|--------------|------------|----|-----|
| 05899 50 283 | 13x0.65x18 | 20 | 100 |

6735

Spare Blade for Pruning Saw



| CODE | L mm | g | |
|--------------|------|----|---|
| 6735 27 1300 | 300 | 60 | 5 |

06765

Plastic Pipe Cutter Spare Blade



| CODE | SIZE | g | |
|--------------|------|-----|---|
| 06765 50 042 | 42 | 73 | 5 |
| 06765 50 063 | 63 | 105 | 5 |

6850

Blade For Mini Tube Cutter
Blade For Standard Tube Cutter



| CODE | SIZE | g | |
|--------------|---------------|---|----|
| 6850 28 1322 | 1/4" - 1 3/8" | 5 | 10 |

6865

Blade For Professional Tube Cutter



| CODE | SIZE | g | |
|--------------|-----------|----|---|
| 6865 28 0150 | 1/8" - 2" | 30 | 5 |

14000 005090

Pro Safety Utility Knife Spare Blade 18 mm



| CODE | (mm) | |
|--------------|------|----|
| 14000 005090 | 18 | 10 |

14000 005088

Pro Utility Knife Spare Blade 18 mm



| CODE | (mm) | |
|--------------|------|----|
| 14000 005088 | 18 | 10 |

14000 005089

Pro Utility Knife Spare Blade 9 mm



| CODE | (mm) | |
|--------------|------|----|
| 14000 005089 | 9 | 10 |

1400C

Pro Util
are Blade 30° 9 mm



| CODE | (mm) | |
|--------------|------|----|
| 14000 005091 | 9 | 10 |

7010-7020

Spare Parts For Standard Pullers

Connection Part, Extension



| CODE | L mm | Used Puller | g | |
|--------------|------|---------------|------|---|
| 7010 29 2033 | 200 | 8x10 - 12x10 | 415 | 1 |
| 7010 29 3033 | 300 | 16x15 - 20x15 | 890 | 1 |
| 7010 29 4033 | 400 | 25x20 - 35x20 | 2350 | 1 |
| | | 37x20 - 52x20 | | |

Arm



| | | | |
|--------------|---------------|-----|---|
| 7010 29 0822 | 8x10 - 12x10 | 110 | 1 |
| 7010 29 1622 | 16x15 - 20x15 | 330 | 1 |
| 7010 29 2522 | 25x20 - 35x20 | 775 | 1 |
| | 52x20 - 37x20 | | |

Connection Part



| | | | |
|--------------|---------------|-----|---|
| 7010 29 0833 | 8x10 - 12x10 | 160 | 1 |
| 7010 29 1633 | 16x15 - 20x15 | 325 | 1 |
| 7010 29 2533 | 25x20 - 35x20 | 930 | 1 |
| | 52x20 - 37x20 | | |

Spindle



| | | | |
|--------------|---------------|------|---|
| 7010 29 0844 | 8x10 - 12x10 | 185 | 1 |
| 7010 29 1644 | 16x15 - 20x15 | 555 | 1 |
| 7010 29 2544 | 25x20 | 1400 | 1 |
| 7010 29 3544 | 35x20 - 37x20 | 2185 | 1 |
| 7010 29 5244 | 52x20 | 3210 | 1 |

7030-7040

Spare Parts For Master Puller

Arm



| CODE | Used Puller | g | |
|--------------|-------------|-----|---|
| 7030 29 0822 | 8x8 | 110 | 1 |
| 7030 29 1222 | 12x12 | 215 | 1 |
| 7030 29 1622 | 16x16 | 345 | 1 |
| 7030 29 2322 | 23x20 | 580 | 1 |

Spindle



| | | | |
|--------------|-------|------|---|
| 7030 29 0844 | 8x8 | 180 | 1 |
| 7030 29 1244 | 12x12 | 360 | 1 |
| 7030 29 1644 | 16x16 | 680 | 1 |
| 7030 29 2344 | 23x20 | 1230 | 1 |

7050-7060

Spare Parts For Battery Pullers

Arm



| CODE | Used Puller | g | |
|--------------|-------------|-----|---|
| 7050 29 0422 | 6x4 | 40 | 1 |
| 7050 29 0622 | 6x6 | 50 | 1 |
| 7050 29 0822 | 8x8 | 110 | 1 |

Spindle



| | | | |
|--------------|-----|-----|---|
| 7050 29 0444 | 6x4 | 95 | 1 |
| 7050 29 0644 | 6x6 | 105 | 1 |
| 7050 29 0844 | 8x8 | 200 | 1 |

7070-7080

Spare Parts For S Type Puller

Arm



| CODE | Used Puller | g | |
|--------------|-------------|-----|---|
| 7070 29 2022 | 20x13 | 405 | 1 |

Spindle



| | | | |
|--------------|-------|-----|---|
| 7070 29 2044 | 20x13 | 520 | 1 |
|--------------|-------|-----|---|

7090-7100

Spare Parts For Universal Puller

Arm



| CODE | Used Puller | g | |
|--------------|-------------|-----|---|
| 7090 29 2322 | 22x22 | 690 | 1 |

Spindle



| | | | |
|--------------|-------|-----|---|
| 7090 29 2244 | 22x22 | 565 | 1 |
|--------------|-------|-----|---|



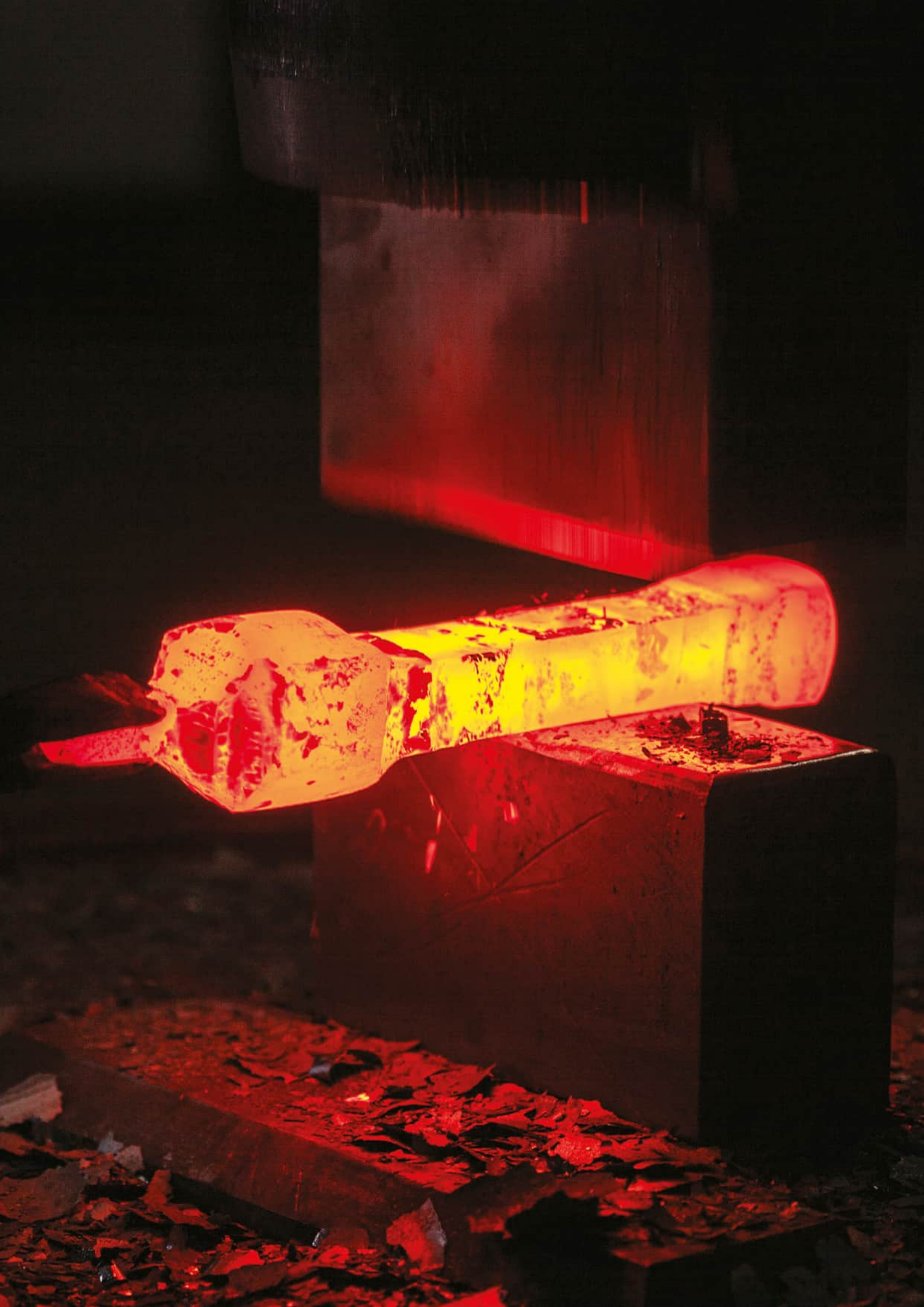

COMMERCIAL DISPLAY PRODUCTS



Display Frame for Sockets



1/2"

| CODE | SIZE mm | g | |
|--------------|-------------|------|---|
| 1113 31 6100 | 175x360x605 | 5800 | 1 |

Display Frame For Pullers



| CODE | CONTENTS | g | |
|--------------|-------------|------|---|
| 7010 31 6105 | Boş - Empty | 2000 | 1 |

Display Frame for Bolt Cutters

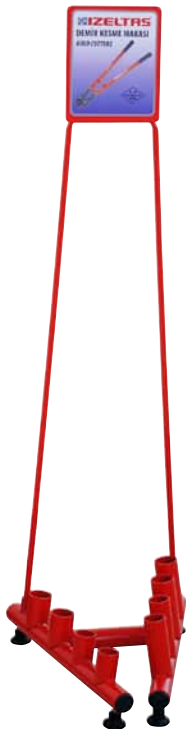

| CODE | CONTENTS | g | |
|--------------|-------------|------|---|
| 2350 31 6104 | Boş - Empty | 7400 | 1 |

Display Frame for Screw Clamps



| CODE | SIZE mm | g | |
|--------------|--------------|------|---|
| 7300 31 6150 | 100x520x1420 | 8000 | 1 |

8001-8002

Display Frame For Wrenches



Made from metal sheet, Electrostatic paint

| CODE | SIZE mm | g | CONTENTS | |
|--------------|---------|------|------------------|---|
| 8001 31 6012 | 160x500 | 800 | Çatal / Open Jaw | 1 |
| 8002 31 6012 | 170x560 | 1000 | Yıldız / Ring | 1 |

8015 31 6001

Triangular Display Frame



Made from metal sheet, Electrostatic paint

| CODE | SIZE mm | g | |
|--------------|----------|-------|---|
| 8015 31 6001 | 520x1670 | 29500 | 1 |

8004 31 6004

Forged Steel Vice Frame



| CODE | CONTENTS | g | |
|--------------|-------------|------|---|
| 8004 31 6004 | Boş - Empty | 8000 | 1 |

İzeltaş's Product Exhibition Board has been specially designed for selling points. These boards have been formed from easily mountable 19 main parts and have the dimensions as following, width 46 cm, length 100 cm and height 220 cm.

Board features an impressive looking and displays the products all together, which makes it easy to choose desired tools during retail selling activities.

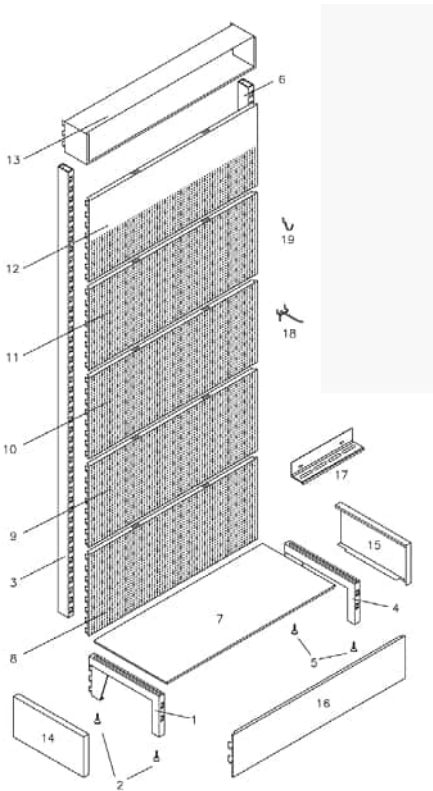

- Montage Order
- Stand right leg
 - Plastic leg
 - Stand right column
 - Stand left leg
 - Plastic leg
 - Stand left column
 - Drilled panel
 - Drilled panel
 - Drilled panel
 - Drilled panel
 - Half - drilled panel
 - Illumination panel
 - Side cover
 - Side cover
 - Front cover
 - Screwdriver hanger
 - Long hanger
 - Short hanger

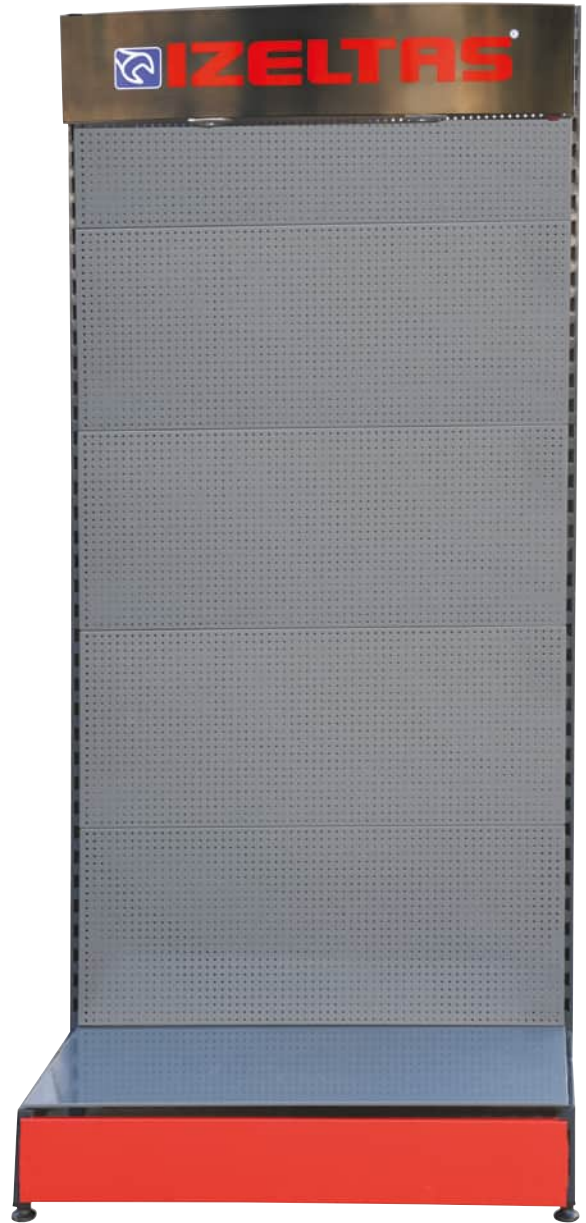

Display Panel (Empty)

| CODE | SIZE mm | Type |  g |  |
|--------------|---------------|-------|--|---|
| 8010 31 6001 | 460x1000x2200 | Empty | 43000 | 1 |

TECHNICAL INFORMATIONS



WORK SAFETY AND INCORRECT USE OF TOOLS



Hand tools with IEC 60900 compliant isolation must be used for any work involving risk of electrical current (excluding 1000V and above).



Make sure to wear goggles in work areas with dust and burrs.



Use box wrenches with bolts of appropriate size, placed perpendicularly on the largest area of contact. Use of a box wrench at an angle will reduce the gripping surface and result in a shorter useful life.



Make sure to wear ear protection in work areas with high levels of noise.



Do not use a hammer outside its intended purpose or to hit objects harder than the hammer. Do not hit at an angle. Make sure to clean weakened parts before use.



Make sure to wear gloves and facemask for works involving chemical materials.

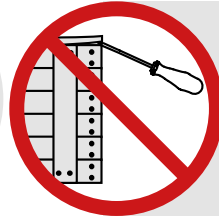

Do not use the screwdriver as a levering tool out of its intended purpose.



Use wrenches with bolts of appropriate size. Size discrepancy between wrench and bolt will lead to wear on tool edge.



Do not use the screwdriver as a chiselling tool or for impacting out of its intended purpose.



Do not grind or expose the edge of wrenches to hard objects. This will deform the tool edge structure.



Do not pull the set cabinets. Push to move the cabinets.



Do not apply force to the wrench by attaching a pipe to the tool body. This may result in deformation of tool edge, breakage or injury.



Do not leave multiple drawers of set cabinets open at the same time. This will move the centre of gravity and cause toppling.



Do not hit the wrench body with a hammer. This may result in deformation of tool edge, breakage or injury.



Do not use your foot to close a cabinet drawer or attempt to use cabinet drawers as a stepladder. Such actions will result in injury.

TECHNICAL DATA

SPANNER JAW WIDTH ACCROSS FLATS and THREAD DIAMETERS

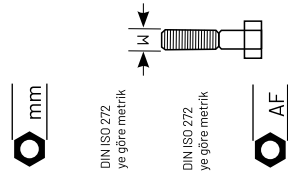

| mm | | DIN ISO 272 ye göre metrik | DIN ISO 272 ye göre metrik | AF | Whitw. | BS 916 1083 | inch | mm |
|-----------|--------|-------------------------------|-------------------------------|--------|--------|-------------------|-------|--------|
| 4 | 2 | | 5/32 | 0,1562 | 3,97 | 8 BA | 0,152 | 3,86 |
| 4,5 | 2,3 | | | | | 7 BA | 0,172 | 4,87 |
| 5 | 2,5 | | 3/16 | 0,1875 | 4,76 | 6 BA | 0,193 | 4,90 |
| 5,5 | 3,5 | | 7/32 | 0,2187 | 5,56 | 5 BA | 0,220 | 5,59 |
| 6 | 26,8 | | 1/4 | 0,2500 | 6,35 | 4 BA | 0,248 | 6,30 |
| | | | | | | 1/16 W | 0,256 | 6,50 |
| 7 | 4 | | 9/32 | 0,2812 | 7,14 | 3 BA | 0,282 | 7,16 |
| | | | | | | 3/32 W | 0,297 | 7,54 |
| 7-8 | 5 | | 5/16 | 0,3125 | 7,94 | 2 BA | 0,324 | 8,23 |
| 9 | 5 Alt | | 11/32 | 0,3438 | 8,73 | 1/8 W (3/16) | 0,340 | 8,64 |
| | | | 3/8 | 0,3750 | 9,52 | 1 BA | 0,365 | 9,27 |
| 8-10 | 6 | | 13/32 | 0,4062 | 10,32 | 0 BA (7/32) | 0,413 | 10,49 |
| 11 | 7 | | 7/16 | 0,4375 | 11,11 | 3/16 W 1/4 | 0,445 | 11,30 |
| 12 | | | | | | | | |
| 10-13 | 8 | | 1/2 | 0,5000 | 12,70 | 1/4 W 5/16 | 0,525 | 13,34 |
| 14* | 8 Alt | | 9/16 | 0,5625 | 14,29 | | | |
| 15 | 10 KFZ | | 19/32 | 0,5938 | 15,08 | 5/16 W 3/8 | 0,600 | 15,24 |
| 16 | 10 | | 5/8 | 0,6250 | 15,88 | | | |
| 13-15-17 | 10 | | 11/16 | 0,6875 | 17,46 | | | |
| 18 | 12 | | | | | 3/8 W 7/16 | 0,710 | 18,03 |
| 15-18-19 | 12 | | 3/4 | 0,7500 | 19,05 | | | |
| 20* | | | 25/32 | 0,7812 | 19,84 | | | |
| 18-21 | 14 | | 13/16 | 0,8125 | 20,64 | 7/16 W 1/2 | 0,820 | 20,83 |
| 22-24 | 14 | 12 | 7/8 | 0,8750 | 22,22 | | | |
| 23* | | | | | | 1/2 W 9/16 | 0,920 | 23,37 |
| 21-24* | 16 | | 15/16 | 0,9375 | 23,81 | | | |
| 25*-27* | | | 1, | 1,0000 | 25,40 | | | |
| 26* | | | | | | 9/16 W 5/8 | 1,010 | 25,65 |
| 27 | 18 | 16 | 1.1/16 | 1,0625 | 26,99 | | | |
| 27-28*-30 | | | | | | 5/8 W (11/16) | 1,100 | 27,94 |
| | | | 1.1/8 | 1,1250 | 28,58 | | | |
| 27-30-34 | 20 | | 1.3/16 | 1,1875 | 30,16 | 11/16 W 3/4 | 1,200 | 30,48 |
| 32-36-41 | 22 | 20 | 1.1/4 | 1,2500 | 31,75 | | | |
| | | | 1.5/16 | 1,3125 | 33,34 | 3/4 W 7/8 | 1,300 | 33,02 |
| 34 | 22 | | 1.3/8 | 1,3750 | 34,92 | 13/16 W (15/16) | 1,390 | 35,31 |
| 36-41 | 24 | 22 | 1.7/16 | 1,4375 | 36,51 | | | |
| 38* | | | 1.1/2 | 1,5000 | 38,10 | 7/8 W 1 | 1,480 | 37,59 |
| 41-46 | 27 | 24 | 1.5/8 | 1,6250 | 41,28 | | | |
| | | | 1.11/16 | 1,6875 | 42,86 | 1. W 1.1/8 | 1,670 | 42,42 |
| | | | 1.3/4 | 1,7500 | 44,45 | | | |
| 46-50 | 30 | 27 | 1.13/16 | 1,8125 | 46,04 | | | |
| | | | 1.7/8 | 1,8750 | 47,62 | 1.1/8 W 1.1/4 | 1,860 | 47,24 |
| 50-55 | 33 | 30 | 2, | 2,0000 | 50,80 | | | |
| | | | 2.1/16 | 2,0625 | 52,39 | 1.1/4 W 1.3/8 | 2,050 | 52,07 |
| 55-60 | 36 | | 2.3/16 | 2,1875 | 55,56 | | | |
| | | | 2.1/4 | 2,2500 | 57,15 | 1.3/8 W 1.1/2 | 2,220 | 56,39 |
| 60-65 | 39 | 36 | 2.3/8 | 2,3750 | 60,32 | | | |
| | | | 2.7/16 | 2,4375 | 61,91 | 1.1/2 W 1.5/8 | 2,410 | 61,21 |
| 65 | 42 | | 2.9/16 | 2,5625 | 65,09 | 1.5/8 1.3/4 | 2,580 | 65,53 |
| | | | 2.5/8 | 2,6250 | 66,68 | | | |
| 70 | 45 | | 2.3/4 | 2,7500 | 69,85 | 1.3/4 W 2, | 2,760 | 70,10 |
| | | | 2.13/16 | 2,8125 | 71,44 | | | |
| 75 | 48 | | 2.15/16 | 2,9375 | 74,61 | | | |
| | | | 3, | 3,0000 | 76,20 | (1.7/8 W) 2.1/4 | 3,150 | 80,01 |
| 80 | 52 | | 3.1/8 | 3,1250 | 79,38 | | | |
| 85 | 56 | | 3.3/8 | 3,3750 | 85,72 | | | |
| 90 | 60 | | 3.1/2 | 3,5000 | 88,90 | 2.1/2 | 3,550 | 90,17 |
| 95 | 64 | | 3.3/4 | 3,7500 | 92,25 | | | |
| | | | 3.7/8 | 3,8750 | 98,42 | 2.3/4 | 3,890 | 98,81 |
| 100 | 68 | | | | | | | |
| 105 | 72 | | 4.1/8 | 4,1250 | 104,78 | 3, | 4,180 | 106,17 |
| 110 | 76 | | 4.1/4 | 4,2500 | 107,95 | | | |
| 115* | 80 | | 4.1/2 | 4,5000 | 114,30 | 3.1/4 | 4,530 | 115,06 |

TEST TORQUE VALUES FOR SPANNERS ISO 1711-1

| | 0430 0320 0330 0370 | 0440 | 0100 0130 | 1800 | 1870 1874 |
|------|------------------------------|------|--------------|------|--------------|
| 4 | | | 1,90 | | |
| 4.5* | | | 2,64 | | |
| 5 | | | 3,55 | | |
| 5,5 | | | 4,64 | | |
| 6* | 17,6 | 7,4 | 5,92 | 17,6 | |
| 7 | 25,2 | 11,4 | 9,12 | 25,2 | |
| 8 | 34,5 | 16,6 | 13,3 | 34,5 | 34,5 |
| 9* | 45,5 | 23,0 | 18,4 | 45,5 | 45,5 |
| 10 | 58,1 | 31,0 | 24,8 | 58,1 | 58,1 |
| 11 | 72,7 | 40,4 | 32,3 | 72,7 | 72,7 |
| 12 | 89,1 | 51,5 | 41,2 | 89,1 | 89,1 |
| 13 | 107 | 64,5 | 51,6 | 107 | 107 |
| 14* | 128 | 79,4 | 63,5 | 128 | 128 |
| 15 | 150 | 96,2 | 77,0 | 150 | 150 |
| 16 | 175 | 115 | 92,3 | 175 | 175 |
| 17 | 201 | 134 | 107 | 201 | 201 |
| 18 | 230 | 160 | 128 | 230 | 230 |
| 19* | 261 | 186 | 149 | 261 | 261 |
| 20* | 294 | 215 | 172 | 294 | 294 |
| 21 | 330 | 247 | 198 | 330 | 330 |
| 22* | 368 | 281 | 225 | 368 | 368 |
| 23* | 408 | 319 | 255 | 408 | 408 |
| 24 | 451 | 359 | 287 | 451 | 451 |
| 25* | 496 | 402 | 322 | 496 | 496 |
| 26* | 544 | 449 | 359 | 544 | 544 |
| 27 | 594 | 499 | 399 | 594 | 594 |
| 28* | 647 | 552 | 442 | 647 | 647 |
| 30 | 760 | 670 | 536 | 760 | 760 |
| 32* | 884 | 804 | 643 | 884 | 884 |
| 34 | 1019 | 951 | 761 | 1019 | 1019 |
| 36 | 1165 | 1117 | 994 | 1165 | 1165 |
| 41 | 1579 | 1442 | 1154 | 1579 | 1579 |
| 46 | 2067 | 1816 | 1453 | 2067 | 2067 |
| 50 | 2512 | 2145 | 1716 | 2512 | 2512 |
| 55 | 3140 | | 2077 | 3140 | 3140 |
| 60 | 3849 | | 2471 | 3849 | |
| 65 | 4021 | | | | |
| 70 | 4658 | | | | |
| 75 | 5394 | | | | |



GUIDELINE FOR SCREWDRIVERS

|  | | | | | | | | | | | |
|---|------------------|-----------|-----------|--------------------|-----------|-----------|-----------|-----------|----------|----------|----------|
| Metric screw" | M 1.6 (M 1.7) | M 2 | M 2.3 | (M 2.3) (M 2.6) | M 3 | (M 3.5) | M 4 | M 5 | M 6 | M 8 | M 10 |
| Flat head screws | 0.4 x 3 (3.2) | 0.5 x 3.8 | 0.6 x 4.4 | 0.6 x 4.5 (5) | 0.8 x 5.5 | 0.8 x 6 | 1 x 7 | 1.2 x 8.5 | 1.6 x 10 | 2 x 13 | 2.5 x 16 |
| Flat head screws | — | — | — | — | 0.8 x 6 | 0.8 x 7 | 1 x 8 | 1.2 x 10 | 1.6 x 12 | 2 x 16 | 2.5 x 20 |
| Flat head screws (small sizes) | — | — | — | 0.4 x 3.5 | 0.5 x 4 | 0.5 x 4.5 | 0.6 x 5.5 | 0.8 x 6.5 | 1 x 8 | 1.2 x 10 | 1.6 x 13 |
| Oval head screws | 0.4 x 3 | 0.5 x 3.8 | — | 0.6 x 4.7 | 0.8 x 5.6 | — | — | — | — | — | — |
| Countersank head screws | 0.4 x 3 | 0.5 x 3.8 | — | 0.6 x 4.7 | 0.8 x 5.6 | 0.8 x 6.5 | 1 x 7.5 | 1.2 x 9.2 | 1.6 x 11 | 2 x 14.5 | 2.5 x 18 |

SUITABLE TIPS FOR CROSS HEAD SCREWS

|  | | |
|---|-----------------|-------------------|
| | Cross Slot Size | Metric Screw |
| | 0 | M 1.6 - M 2 |
| | 1 | M 2 - M 2.5 - M 3 |
| | 2 | M 3.5 - M 5 |
| | 3 | M 6 |
| | 4 | M 8 - M 10 |



TECHNICAL DATA

GUIDE TO METRIC SIZES COVERED BY SOCKET WRENCHES FOR EACH DRIVE

| | 1107 6.3 | 1110 10 | 1113 12.5 | 1119 20 | 1125 25 | | |
|-------|-------------|------------|--------------|------------|------------|----|----|
| | 1/4" | 3/8" | 1/2" | 3/4" | 1" | | |
| M 2 | 4 | | | | | | |
| | 4,5 | | | | | | |
| M 2.5 | 5 | | | | | | |
| M 3 | 5,5 | | | | | | |
| M 3.5 | 6 | 6 | | | | | |
| M 4 | 7 | 7 | | | | | |
| M 5 | 8 | 8 | 8 | | | | |
| | 9 | 9 | 9 | | | | |
| M 6 | 10 | 10 | 10 | 10 | | | |
| M 7 | 11 | 11 | 11 | 11 | | | |
| | 12 | 12 | 12 | 12 | | | |
| M 8 | 13 | 13 | 13 | 13 | | | |
| | | 14 | 14 | 14 | | | |
| | | 15 | 15 | 15 | | | |
| M 10 | | 16 | 16 | 16 | | | |
| M 10 | | 17 | 17 | 17 | 17 | | |
| M 12 | | 18 | 18 | 18 | 18 | | |
| M 12 | | 19 | 19 | 19 | 19 | | |
| | | 20 | 20 | | | | |
| M 14 | | 21 | 21 | 21 | 21 | | |
| M 14 | | 22 | 22 | 22 | 22 | 22 | 22 |
| | | 23 | 23 | 23 | | | |
| M 16 | | | 24 | 24 | 24 | 24 | 24 |
| | | | 25 | | | | |
| | | | 26 | | | | |
| M 18 | | | 27 | 27 | 27 | 27 | 27 |
| | | | 28 | | | | |
| M 20 | | | 30 | 30 | 30 | 30 | 30 |
| M 22 | | | 32 | 32 | 32 | 32 | 32 |
| | | | | 33 | 33 | 33 | 33 |
| M 22 | | | 34 | 34 | 34 | 34 | 34 |
| M 24 | | | | 36 | 36 | 36 | 36 |
| | | | | 38 | 38 | 38 | 38 |
| M 27 | | | | 41 | 41 | 41 | 41 |
| | | | | | 42 | | |
| M 30 | | | | 46 | 46 | 46 | |
| M 33 | | | | 50 | 50 | | |
| M 36 | | | | 55 | 55 | | |
| M 39 | | | | 60 | 60 | | |
| M 42 | | | | | 65 | | |
| M 45 | | | | | 70 | | |
| M 48 | | | | | 75 | | |
| M 52 | | | | | | | |

TEST TORQUE VALUES FOR SOCKET WRENCHES ISO 1711-1(N-m)

| | | 6,3 1107 | 10 1110 | 12,5 1113 1114 | 20 1119 1120 | 25 1125 |
|-------|------|-------------|------------|----------------------|--------------------|------------|
| | | 1/4" | 3/8" | 1/2" | 3/4" | 1" |
| M2 | 4 | 10,4 | | | | |
| M 2.2 | 4,5* | 12,6 | | | | |
| M 2.5 | 5 | 15,1 | | | | |
| M 3 | 5,5 | 17,8 | | | | |
| M 3.5 | 6* | 20,6 | 23,2 | | | |
| M 4 | 7 | 26,8 | 33,2 | | | |
| M 5 | 8 | 33,6 | 45,5 | 94,1 | | |
| | 9* | 41,1 | 59,9 | 119,2 | | |
| M 6 | 10 | 49,1 | 76,7 | 147 | | |
| M 7 | 11 | 57,8 | 96 | 178 | | |
| | 12 | 67,0 | 118 | 212 | | |
| M 8 | 13 | 68,6 | 141 | 249 | | |
| | 14* | 569 68,6 | 169 | 288 | | |
| | 15 | | 198 | 331 | | |
| | 16 | | 225 | 377 | | |
| M 10 | 17 | | 225 | 425 | | |
| | 18 | | 225 | 477 | | |
| M 12 | 19* | | 225 | 531 | | |
| | 20* | | 225 | | | |
| | 21 | | 225 | 569 | - | |
| M 14 | 22* | | 225 | 569 | 569 | |
| | 23* | | | 569 | 569 | |
| M 16 | 24 | | | 569 | 569 | |
| | 25* | | | 569 | 583 | |
| | 26* | | | 569 | 624 | |
| M 18 | 27 | | | 569 | 665 | |
| | 28* | | | 569 | 707 | |
| M 20 | 30 | | | 569 | 795 | |
| M 22 | 32* | | | 569 | 888 | |
| | 34 | | | 569 | 984 | |
| M 24 | 36 | | | | 1084 | 1677 |
| M 27 | 41 | | | | 1353 | 1910 |
| M 30 | 46 | | | | 1569 | 2143 |
| M 33 | 50 | | | | 1569 | 2329 |
| M 36 | 55 | | | | 1569 | 2562 |
| M 39 | 60 | | | | 1569 | 2795 |
| M 42 | 65 | | | | | 2795 |
| M 45 | 70 | | | | | 2795 |
| M 48 | 75 | | | | | 2795 |
| M 52 | 80 | | | | | 2795 |



TIGHTENING / TEST TORQUE VALUES

Suggested (Not Compulsory) Bolt Tightening Torque in Nm (Newton Meter)

Tightening Torques Values According to Quality Class DIN 267

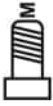
|  | 4.6 | 5.6 | 6.9 | 8.8 | 10.9 | 12.9 |
|---|-------|--------|--------|--------|--------|--------|
| M 2 | 0,123 | 0,162 | 0,314 | 0,373 | 0,520 | 0,628 |
| M 2,2 | 0,196 | 0,265 | 0,510 | 0,598 | 0,843 | 1,010 |
| M 2,5 | 0,284 | 0,373 | 0,726 | 0,863 | 1,206 | 1,451 |
| M 3 | 0,441 | 0,588 | 1,128 | 1,344 | 1,883 | 2,256 |
| M 3,5 | 0,677 | 0,902 | 1,736 | 2,060 | 2,893 | 3,481 |
| M 4 | 1,000 | 1,344 | 2,599 | 3,040 | 4,315 | 5,148 |
| M 5 | 1,916 | 2,648 | 5,099 | 6,031 | 8,483 | 10,200 |
| M 6 | 3,432 | 4,511 | 8,728 | 10,300 | 14,710 | 17,652 |
| M 7 | 5,590 | 7,453 | 14,220 | 17,162 | 24,517 | 28,439 |
| M 8 | 8,238 | 10,787 | 21,575 | 25,497 | 35,304 | 42,168 |
| M 10 | 16,67 | 21,575 | 42,168 | 50,014 | 70,608 | 85,317 |
| M 12 | 28,44 | 38,246 | 73,550 | 87,279 | 122,60 | 147,10 |
| M 14 | 45,11 | 60,801 | 116,70 | 138,30 | 194,20 | 235,40 |
| M 16 | 69,63 | 93,163 | 178,5 | 210,80 | 299,10 | 357,90 |
| M 18 | 95,12 | 127,50 | 245,20 | 289,3 | 411,90 | 490,30 |
| M 20 | 135,3 | 180,45 | 384,10 | 411,90 | 578,60 | 696,30 |
| M 22 | 182,4 | 245,16 | 470,70 | 559,00 | 784,50 | 941,40 |
| M 24 | 230,5 | 308,91 | 598,20 | 711,00 | 1000 | 1196 |
| M 27 | 343,2 | 460,90 | 887,50 | 1049 | 1481 | 1775 |
| M 30 | 465,8 | 622,72 | 1206 | 1422 | 2010 | 2403 |
| M 33 | 632,5 | 848,30 | 1628 | 1932 | 2716 | 3266 |
| M 36 | 814,0 | 1089 | 2099 | 2481 | 3491 | 4197 |
| M 39 | 1059 | 1412 | 2716 | 3226 | 4531 | 5443 |
| M 42 | 1304 | 1746 | 3364 | 3991 | 5609 | 6727 |
| M 45 | 1638 | 2177 | 4207 | 4992 | 7012 | 8414 |
| M 48 | 1981 | 2638 | 5080 | 6021 | 8473 | 10150 |
| M 52 | 2540 | 3393 | 6541 | 7747 | 10885 | 13092 |
| M 56 | 3168 | 4227 | 8149 | 9650 | 13582 | 16279 |
| M 60 | 3932 | 5247 | 10101 | 11964 | 16867 | 20202 |
| M 64 | 4737 | 6306 | 12160 | 14416 | 20300 | 24320 |

Torque Values Should be Decreased of 20% for Lubricated Screws

TECHNICAL DATA

Measuring Units

| | | | | |
|-------|---|---------------|-------------------|---------------------------|
| Giga | G | 1.000.000.000 | =10 ⁹ | 1GW= 1 Milyar Watt |
| Mega | M | 1.000.000 | =10 ⁶ | 1 MW= 1 Milyon Watt |
| Kilo | k | 1.000 | =10 ³ | 1 kW= Bin Watt |
| Milli | m | 0.001 | =10 ⁻³ | 1 mm= Binde Bir Watt |
| Mikro | m | 0.000001 | =10 ⁻⁶ | 1 mm= 1 Milyonda Bir Watt |
| Nano | n | 0.000000001 | =10 ⁻⁹ | 1 nm= 1 Milyarda Bir Watt |

Conversion Table For Essential Measuring Units

| | | | | |
|---------------------------------------|-------------|----|----------------------|--------------------------|
| Uzunluk Length | Metre | m | | |
| Kütle Weight | Kilogram | kg | | |
| Zaman Time | Saniye | s | | |
| Kuvvet Force | Newton | N | =kg m/s ² | 1 N= 0.102 kp |
| Döndürme Mom. Torque | Newtonmetre | | | 9.81 Nm= 1kpm |
| İş Enerjisi Work | Joule | J | =Nm | |
| Isı Enerjisi Heat | Joule | J | | 1 J= 0.239 cal |
| Güç Power | Watt | W | =Nm/s | 1 kW= 1.36 PS=860 kcal/h |
| Basınç Pressure | Pascal | Pa | =N/m ² | 100.000 Pa=1 bar=10 mWS |
| Elektrik Akımı Electricity Current | Amper | A | | |
| Sıcaklık Temperature | Kelvin | K | | 1K= -272.15 °C |

Conversion Table For Bending Moments

| Var Olan Ölçüler/ present units | İstenen Ölçüler / Wanted Units | | | | | |
|--|--------------------------------|---------|---------|---------|----------|----------|
| | =Ncm | =Nm | =kpcm | =kpm | =lbf.in. | =lbf.ft. |
| Ncm | 1 | 0.01 | 0.10197 | 0.00102 | 0.0885 | 0.00738 |
| Nm | 100 | 1 | 10.197 | 0.10197 | 8.851 | 0.7376 |
| kpcm | 9.807 | 0.09807 | 1 | 0.01 | 0.868 | 0.0723 |
| kpm | 980.07 | 9.807 | 100 | 1 | 86.796 | 7.233 |
| lbf.in. | 11.298 | 0.11298 | 1.152 | 0.01152 | 1 | 0.0833 |
| lbf.ft. | 135.58 | 1.3558 | 13.825 | 0.13825 | 12 | 1 |

Conversion Table Of Newton-Meter And Librefoot (1 Nm=0.738 lbf.ft.)

| Nm | ft.,lbs. | | | | | | | | | |
|-----|----------|-------|-------|-------|-------|-------|-------|-------|-------|-------|
| | 0 | 1 | 2 | 3 | 4 | 5 | 6 | 7 | 8 | 9 |
| 0 | 0 | 0.74 | 1.48 | 2.21 | 2.95 | 3.69 | 4.43 | 5.17 | 5.90 | 6.64 |
| 10 | 7.38 | 8.12 | 8.86 | 9.59 | 10.33 | 11.07 | 11.81 | 12.54 | 13.28 | 14.02 |
| 20 | 14.76 | 15.50 | 16.2 | 16.97 | 17.71 | 18.45 | 19.19 | 19.93 | 20.65 | 21.40 |
| 30 | 22.14 | 22.88 | 23.62 | 24.35 | 25.10 | 25.83 | 26.57 | 27.31 | 28.04 | 28.78 |
| 40 | 29.52 | 30.26 | 31.00 | 31.73 | 32.47 | 33.21 | 33.95 | 34.69 | 35.42 | 36.16 |
| 50 | 36.90 | 37.64 | 38.38 | 39.11 | 39.85 | 40.59 | 41.33 | 42.07 | 42.80 | 43.54 |
| 60 | 44.28 | 45.02 | 45.76 | 46.49 | 47.23 | 47.97 | 48.71 | 49.45 | 50.18 | 50.92 |
| 70 | 51.66 | 52.40 | 53.14 | 53.87 | 54.61 | 55.35 | 56.09 | 56.83 | 57.56 | 58.30 |
| 80 | 59.04 | 59.78 | 60.52 | 61.25 | 62.00 | 62.73 | 63.47 | 64.21 | 64.94 | 65.68 |
| 90 | 66.42 | 67.16 | 67.90 | 68.63 | 69.37 | 70.11 | 70.85 | 71.59 | 72.32 | 73.06 |
| 100 | 73.80 | 74.54 | 75.28 | 76.01 | 76.75 | 77.49 | 78.23 | 78.97 | 79.70 | 80.44 |

Conversion Table Of Librefoot And Newton-Meter (1 lbf.ft.=1.356 Nm)

| ft.- lbs. | Nm | | | | | | | | | |
|--------------|--------|--------|--------|--------|--------|--------|--------|--------|--------|--------|
| | 0 | 1 | 2 | 3 | 4 | 5 | 6 | 7 | 8 | 9 |
| 0 | 0 | 1.36 | 2.71 | 4.07 | 5.42 | 6.78 | 8.14 | 9.49 | 10.85 | 12.20 |
| 10 | 13.56 | 14.92 | 16.27 | 17.63 | 18.98 | 20.34 | 21.70 | 23.05 | 24.41 | 25.76 |
| 20 | 27.12 | 28.48 | 29.83 | 31.19 | 32.54 | 33.90 | 35.26 | 36.61 | 37.97 | 39.32 |
| 30 | 40.68 | 42.04 | 43.39 | 44.75 | 46.10 | 47.46 | 48.82 | 50.17 | 51.53 | 52.88 |
| 40 | 54.24 | 55.60 | 56.95 | 58.31 | 59.66 | 61.02 | 62.38 | 63.73 | 65.09 | 66.44 |
| 50 | 67.80 | 69.16 | 70.51 | 71.87 | 73.22 | 74.58 | 75.94 | 77.29 | 78.65 | 80.00 |
| 60 | 81.36 | 82.72 | 84.07 | 85.43 | 86.78 | 88.14 | 89.50 | 90.85 | 92.21 | 93.56 |
| 70 | 94.92 | 96.28 | 97.63 | 98.99 | 100.34 | 101.70 | 103.06 | 104.41 | 105.77 | 107.12 |
| 80 | 108.48 | 109.84 | 111.19 | 112.55 | 113.90 | 115.26 | 116.62 | 117.97 | 119.33 | 120.68 |
| 90 | 122.04 | 123.40 | 124.75 | 126.11 | 127.46 | 128.82 | 130.18 | 131.53 | 132.89 | 134.24 |
| 100 | 135.60 | 136.96 | 138.31 | 139.67 | 141.02 | 142.38 | 143.74 | 145.09 | 146.45 | 147.80 |

Conversion Table Of Newton-Meter and Kilopound-Meter (1 Nm=0.102 kpm)

| Nm | kpm | | | | | | | | | |
|------|--------|--------|--------|--------|--------|--------|--------|--------|--------|--------|
| | 0 | 1 | 2 | 3 | 4 | 5 | 6 | 7 | 8 | 9 |
| 0 | 0.00 | 1.02 | 2.04 | 3.06 | 4.08 | 5.10 | 6.12 | 7.14 | 8.16 | 9.18 |
| 100 | 10.20 | 11.22 | 12.24 | 13.26 | 14.28 | 15.30 | 16.31 | 17.33 | 18.35 | 19.37 |
| 200 | 20.39 | 21.41 | 22.43 | 23.45 | 24.47 | 25.49 | 26.51 | 27.53 | 28.55 | 29.57 |
| 300 | 30.59 | 31.61 | 32.63 | 33.65 | 34.67 | 35.69 | 36.71 | 37.73 | 38.75 | 39.77 |
| 400 | 40.79 | 41.81 | 42.83 | 43.85 | 44.87 | 45.89 | 46.91 | 47.93 | 48.95 | 49.97 |
| 500 | 50.99 | 52.00 | 53.02 | 54.04 | 55.06 | 56.08 | 57.10 | 58.12 | 59.14 | 60.16 |
| 600 | 61.18 | 62.20 | 63.22 | 64.24 | 65.26 | 66.28 | 67.30 | 68.32 | 69.34 | 70.36 |
| 700 | 71.38 | 72.40 | 73.42 | 74.44 | 75.46 | 76.48 | 77.50 | 78.52 | 79.54 | 80.56 |
| 800 | 81.58 | 82.60 | 83.62 | 84.64 | 85.66 | 86.68 | 87.70 | 88.71 | 89.73 | 90.75 |
| 900 | 91.77 | 92.79 | 93.81 | 94.83 | 95.85 | 96.87 | 97.89 | 98.91 | 99.93 | 100.95 |
| 1000 | 101.97 | 102.99 | 104.01 | 105.03 | 106.05 | 107.07 | 108.09 | 109.11 | 110.13 | 111.15 |









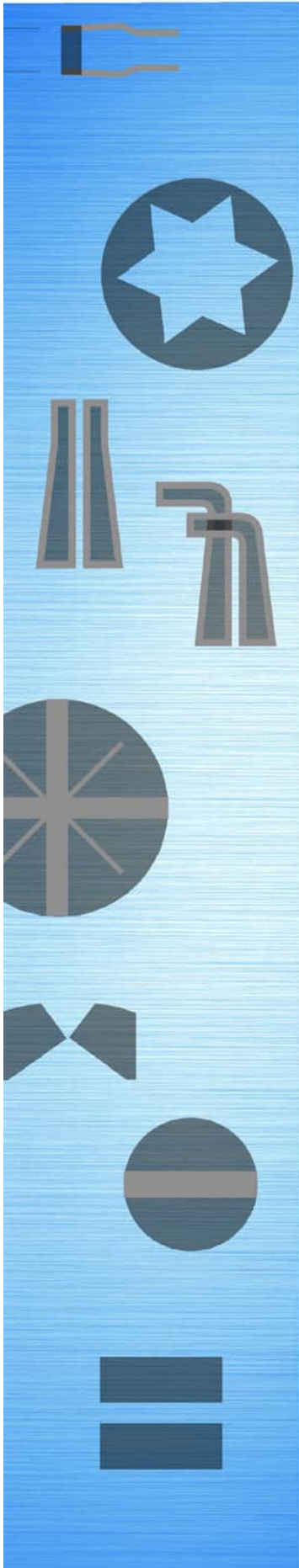













Hardness Conversion Table

| Sertlik Hardness | | | | | Sertlik Hardness | | | | | | | | | |
|------------------|-------|------------------|------|----------------------|------------------|------------------|-----|------|----------------------|-------|------------------|-----|------|----------------------|
| Sertlik Hardness | | Sertlik Hardness | | Sertlik Hardness | | Tensile Strength | | | Sertlik Hardness | | Tensile Strength | | | |
| HV 30 | HB 30 | HRB | HRC | sB N/mm ² | HV 30 | HB 30 | HRB | HRC | sB N/mm ² | HV 30 | HB 30 | HRB | HRC | sB N/mm ² |
| 80 | 80.7 | 36.4 | - | 270 | 340 | 340 | - | 34.9 | 1140 | 340 | 340 | - | 34.9 | 1140 |
| 85 | 85 | 42.4 | - | 290 | 350 | 350 | - | 36.0 | 1170 | 350 | 350 | - | 36.0 | 1170 |
| 90 | 90 | 47.4 | - | 310 | 360 | 359 | - | 37.0 | 1200 | 360 | 359 | - | 37.0 | 1200 |
| 95 | 95 | 52.00 | - | 320 | 370 | 368 | - | 38.0 | 1260 | 370 | 368 | - | 38.0 | 1260 |
| 100 | 100 | 56.4 | - | 340 | 380 | 376 | - | 38.9 | 1260 | 380 | 376 | - | 38.9 | 1260 |
| 105 | 105 | 60.0 | - | 360 | 390 | 385 | - | 39.8 | 1290 | 390 | 385 | - | 39.8 | 1290 |
| 110 | 110 | 63.4 | - | 380 | 400 | 392 | - | 40.7 | 1320 | 400 | 392 | - | 40.7 | 1320 |
| 115 | 115 | 66.4 | - | 390 | 410 | 400 | - | 41.5 | 1350 | 410 | 400 | - | 41.5 | 1350 |
| 120 | 120 | 69.4 | - | 410 | 420 | 408 | - | 42.4 | 1380 | 420 | 408 | - | 42.4 | 1380 |
| 125 | 125 | 72.0 | - | 420 | 440 | 423 | - | 44.0 | 1430 | 440 | 423 | - | 44.0 | 1430 |
| 130 | 130 | 74.4 | - | 440 | 450 | 430 | - | 44.8 | 1460 | 450 | 430 | - | 44.8 | 1460 |
| 135 | 135 | 76.4 | - | 460 | 460 | - | - | 45.6 | - | 460 | - | - | - | - |
| 140 | 140 | 78.4 | - | 470 | 470 | - | - | 46.3 | - | 470 | - | - | - | - |
| 145 | 145 | 80.4 | - | 490 | 480 | - | - | 47.0 | - | 480 | - | - | - | - |
| 150 | 150 | 82.2 | - | 500 | 490 | - | - | 47.7 | - | 490 | - | - | - | - |
| 155 | 155 | 83.8 | - | 520 | 500 | - | - | 48.3 | - | 500 | - | - | - | - |
| 160 | 160 | 85.4 | - | 540 | 510 | - | - | 49.1 | - | 510 | - | - | - | - |
| 165 | 165 | 86.8 | - | 550 | 520 | - | - | 49.7 | - | 520 | - | - | - | - |
| 170 | 170 | 88.2 | - | 570 | 530 | - | - | 50.4 | - | 530 | - | - | - | - |
| 175 | 175 | 89.6 | - | 590 | 540 | - | - | 51.0 | - | 540 | - | - | - | - |
| 180 | 180 | 90.8 | - | 600 | 550 | - | - | 51.6 | - | 550 | - | - | - | - |
| 185 | 185 | 91.8 | - | 620 | 560 | - | - | 52.2 | - | 560 | - | - | - | - |
| 195 | 190 | 91.5 | - | 640 | 570 | - | - | 52.8 | - | 570 | - | - | - | - |
| 200 | 195 | 94.0 | - | 660 | 580 | - | - | 53.3 | - | 580 | - | - | - | - |
| 200 | 200 | 95.0 | - | 670 | 590 | - | - | 53.9 | - | 590 | - | - | - | - |
| 205 | 205 | 95.8 | - | 680 | 600 | - | - | 54.4 | - | 600 | - | - | - | - |
| 210 | 210 | 96.6 | - | 710 | 610 | - | - | 55.0 | - | 610 | - | - | - | - |
| 215 | 215 | 97.4 | - | 720 | 620 | - | - | 55.5 | - | 620 | - | - | - | - |
| 220 | 220 | 98.2 | - | 730 | 630 | - | - | 56.0 | - | 630 | - | - | - | - |
| 225 | 225 | 99.0 | - | 750 | 640 | - | - | 56.5 | - | 640 | - | - | - | - |
| 230 | 230 | - | 19.2 | 760 | 650 | - | - | 57.0 | - | 650 | - | - | - | - |
| 235 | 235 | - | 20.2 | 780 | 660 | - | - | 57.5 | - | 660 | - | - | - | - |
| 240 | 240 | - | 21.2 | 800 | 670 | - | - | 58.0 | - | 670 | - | - | - | - |
| 245 | 245 | - | 22.1 | 820 | 680 | - | - | 58.5 | - | 680 | - | - | - | - |
| 250 | 250 | - | 23.0 | 830 | 690 | - | - | 59.0 | - | 690 | - | - | - | - |
| 255 | 255 | - | 23.8 | 850 | 700 | - | - | 59.5 | - | 700 | - | - | - | - |
| 260 | 260 | - | 24.6 | 870 | 720 | - | - | 60.4 | - | 720 | - | - | - | - |
| 265 | 265 | - | 25.4 | 880 | 740 | - | - | 61.2 | - | 740 | - | - | - | - |
| 280 | 280 | - | 27.1 | 900 | 760 | - | - | 62.0 | - | 760 | - | - | - | - |
| 275 | 275 | - | 26.9 | 920 | 780 | - | - | 62.8 | - | 780 | - | - | - | - |
| 280 | 280 | - | 27.6 | 940 | 800 | - | - | 63.6 | - | 800 | - | - | - | - |
| 285 | 285 | - | 28.3 | 950 | 820 | - | - | 64.3 | - | 820 | - | - | - | - |
| 290 | 290 | - | 29.0 | 970 | 840 | - | - | 65.0 | - | 840 | - | - | - | - |
| 295 | 295 | - | 29.6 | 990 | 860 | - | - | 65.7 | - | 860 | - | - | - | - |
| 300 | 300 | - | 30.3 | 1010 | 880 | - | - | 66.3 | - | 880 | - | - | - | - |
| 310 | 310 | - | 31.5 | 1040 | 900 | - | - | 66.9 | - | 900 | - | - | - | - |
| 320 | 320 | - | 32.7 | 1080 | 920 | - | - | 67.5 | - | 920 | - | - | - | - |
| 330 | 330 | - | 33.8 | 1110 | 940 | - | - | 68.0 | - | 940 | - | - | - | - |





Symbols

| | | | |
|---|---------------------------|---|-----------------------------|
|  | Size |  | POZIDRIV [®] Tip |
|  | Opening Limit of Jaws |  | TORX [®] Tip |
|  | Six Point Sockets |  | TORX [®] with hole |
|  | Eight Point Wrench |  | Bit Holders |
|  | Twelve Point Wrench |  | Hexagonal Allen Keys |
|  | Square Adapter |  | Circlip |
|  | Tubular Socket Wrench |  | Weight of Body |
|  | Single Ended Rim Wrench |  | Wrench for Carter Case |
|  | TORX [®] Socket |  | Screw Clamp |
|  | Flat Tip |  | Puller |
|  | PHILLIPS [®] Tip | | |



| in. | dec.in. | 0" | 1" | 2" | 3" | 4" | 5" | 6" | 7" | 8" | 9" | 10" | 11" |
|-------|-----------|------------------|----------|----------|----------|-----------|-----------|-----------|-----------|-----------|-----------|-----------|-----------|
| | | millimeters (mm) | | | | | | | | | | | |
| 0 | 0 | 0 | 25.400 0 | 50.800 0 | 76.200 0 | 101.600 0 | 127.000 0 | 152.400 0 | 177.800 0 | 203.200 0 | 228.600 0 | 254.000 0 | 279.400 0 |
| 1/64 | 0.015 625 | 0.396 9 | 25.796 9 | 51.196 9 | 76.596 9 | 101.996 9 | 127.396 9 | 152.796 9 | 178.196 9 | 203.596 9 | 228.996 9 | 254.396 9 | 279.796 9 |
| 1/32 | 0.031 25 | 0.793 8 | 26.193 8 | 51.593 8 | 76.993 8 | 102.393 8 | 127.793 8 | 153.193 8 | 178.593 8 | 203.993 8 | 229.393 8 | 254.793 8 | 280.193 8 |
| 3/64 | 0.046 875 | 1.190 6 | 26.590 6 | 51.990 6 | 77.390 6 | 102.790 6 | 128.190 6 | 153.590 6 | 178.990 6 | 204.390 6 | 229.790 6 | 255.190 6 | 280.590 6 |
| 1/16 | 0.062 5 | 1.587 5 | 26.987 5 | 52.387 5 | 77.787 5 | 103.187 5 | 128.587 5 | 153.987 5 | 179.387 5 | 204.787 5 | 230.187 5 | 255.587 5 | 280.987 5 |
| 5/64 | 0.078 125 | 1.984 4 | 27.384 4 | 52.784 4 | 78.184 4 | 103.584 4 | 128.984 4 | 154.384 4 | 179.784 4 | 205.184 4 | 230.584 4 | 255.984 4 | 281.384 4 |
| 3/32 | 0.093 75 | 2.381 2 | 27.781 2 | 53.181 2 | 78.581 2 | 103.981 2 | 129.381 2 | 154.781 2 | 180.181 2 | 205.581 2 | 230.981 2 | 256.381 2 | 281.781 2 |
| 7/64 | 0.109 375 | 2.778 1 | 28.178 1 | 53.578 1 | 78.978 1 | 104.378 1 | 129.778 1 | 155.178 1 | 180.578 1 | 205.978 1 | 231.378 1 | 256.778 1 | 282.178 1 |
| 1/8 | 0.125 | 3.175 0 | 28.575 0 | 53.975 0 | 79.375 0 | 104.775 0 | 130.175 0 | 155.575 0 | 180.975 0 | 206.375 0 | 231.775 0 | 257.175 0 | 282.575 0 |
| 9/64 | 0.140 625 | 3.571 9 | 28.971 9 | 54.371 9 | 79.771 9 | 105.171 9 | 130.571 9 | 155.971 9 | 181.371 9 | 206.771 9 | 232.171 9 | 257.571 9 | 282.971 9 |
| 5/32 | 0.156 25 | 3.968 8 | 29.368 8 | 54.768 8 | 80.168 8 | 105.568 8 | 130.968 8 | 156.368 8 | 181.768 8 | 207.168 8 | 232.568 8 | 257.968 8 | 283.368 8 |
| 11/64 | 0.171 875 | 4.365 6 | 29.765 6 | 55.165 6 | 80.565 6 | 105.965 6 | 131.365 6 | 156.765 6 | 182.165 6 | 207.565 6 | 232.965 6 | 258.365 6 | 283.765 6 |
| 3/16 | 0.187 5 | 4.762 5 | 30.162 5 | 55.562 5 | 80.962 5 | 106.362 5 | 131.762 5 | 157.162 5 | 182.562 5 | 207.962 5 | 233.362 5 | 258.762 5 | 284.162 5 |
| 13/64 | 0.203 125 | 5.159 4 | 30.559 4 | 55.959 4 | 81.359 4 | 106.759 4 | 132.159 4 | 157.559 4 | 182.959 4 | 208.359 4 | 233.759 4 | 259.159 4 | 284.559 4 |
| 7/32 | 0.218 75 | 5.556 2 | 30.956 2 | 56.356 2 | 81.756 2 | 107.156 2 | 132.556 2 | 157.956 2 | 183.356 2 | 208.756 2 | 234.156 2 | 259.556 2 | 284.956 2 |
| 15/64 | 0.234 375 | 5.953 1 | 31.353 1 | 56.753 1 | 82.153 1 | 107.553 1 | 132.953 1 | 158.353 1 | 183.753 1 | 209.153 1 | 234.553 1 | 259.953 1 | 285.353 1 |
| 1/4 | 0.25 | 6.350 0 | 31.750 0 | 57.150 0 | 82.550 0 | 107.950 0 | 133.350 0 | 158.750 0 | 184.150 0 | 209.550 0 | 234.950 0 | 260.350 0 | 285.750 0 |
| 17/64 | 0.265 625 | 6.746 9 | 32.146 9 | 57.546 9 | 82.946 9 | 108.346 9 | 133.746 9 | 159.146 9 | 184.546 9 | 209.946 9 | 235.346 9 | 260.746 9 | 286.146 9 |
| 9/32 | 0.281 25 | 7.143 8 | 32.543 8 | 57.943 8 | 83.343 8 | 108.743 8 | 134.143 8 | 159.543 8 | 184.943 8 | 210.343 8 | 235.743 8 | 261.143 8 | 286.543 8 |
| 19/64 | 0.296 875 | 7.540 6 | 32.940 6 | 58.340 6 | 83.740 6 | 109.140 6 | 134.540 6 | 159.940 6 | 185.340 6 | 210.740 6 | 236.140 6 | 261.540 6 | 286.940 6 |
| 5/16 | 0.312 5 | 7.937 5 | 33.337 5 | 58.737 5 | 84.137 5 | 109.537 5 | 134.937 5 | 160.337 5 | 185.737 5 | 211.137 5 | 236.537 5 | 261.937 5 | 287.337 5 |
| 21/64 | 0.328 125 | 8.334 4 | 33.734 4 | 59.134 4 | 84.534 4 | 109.934 4 | 135.334 4 | 160.734 4 | 186.134 4 | 211.534 4 | 236.934 4 | 262.334 4 | 287.734 4 |
| 11/32 | 0.343 75 | 8.731 2 | 34.131 2 | 59.531 2 | 84.931 2 | 110.331 2 | 135.731 2 | 161.131 2 | 186.531 2 | 211.931 2 | 237.331 2 | 262.731 2 | 288.131 2 |
| 23/64 | 0.359 375 | 9.128 1 | 34.528 1 | 59.928 1 | 85.328 1 | 110.728 1 | 136.128 1 | 161.528 1 | 186.928 1 | 212.328 1 | 237.728 1 | 263.128 1 | 288.528 1 |
| 3/8 | 0.375 | 9.525 0 | 34.925 0 | 60.325 0 | 85.725 0 | 111.125 0 | 136.525 0 | 161.925 0 | 187.325 0 | 212.725 0 | 238.125 0 | 263.525 0 | 288.925 0 |
| 25/64 | 0.390 625 | 9.921 9 | 35.321 9 | 60.721 9 | 86.121 9 | 111.521 9 | 136.921 9 | 162.321 9 | 187.721 9 | 213.121 9 | 238.521 9 | 263.921 9 | 289.321 9 |
| 13/32 | 0.406 25 | 10.318 8 | 35.718 8 | 61.118 8 | 86.518 8 | 111.918 8 | 137.318 8 | 162.718 8 | 188.118 8 | 213.518 8 | 238.918 8 | 264.318 8 | 289.718 8 |
| 27/64 | 0.421 875 | 10.715 6 | 36.115 6 | 61.515 6 | 86.915 6 | 112.315 6 | 137.715 6 | 163.115 6 | 188.515 6 | 213.915 6 | 239.315 6 | 264.715 6 | 290.115 6 |
| 7/16 | 0.437 5 | 11.112 5 | 36.512 5 | 61.912 5 | 87.312 5 | 112.712 5 | 138.112 5 | 163.512 5 | 188.912 5 | 214.312 5 | 239.712 5 | 265.112 5 | 290.512 5 |
| 29/64 | 0.453 125 | 11.509 4 | 36.909 4 | 62.309 4 | 87.709 4 | 113.109 4 | 138.509 4 | 163.909 4 | 189.309 4 | 214.709 4 | 240.109 4 | 265.509 4 | 290.909 4 |
| 15/32 | 0.468 75 | 11.906 2 | 37.306 2 | 62.706 2 | 88.106 2 | 113.506 2 | 138.906 2 | 164.306 2 | 189.706 2 | 215.106 2 | 240.506 2 | 265.906 2 | 291.306 2 |
| 31/64 | 0.484 375 | 12.303 1 | 37.703 1 | 63.103 1 | 88.503 1 | 113.903 1 | 139.303 1 | 164.703 1 | 190.103 1 | 215.503 1 | 240.903 1 | 266.303 1 | 291.703 1 |
| 1/2 | 0.5 | 12.700 0 | 38.100 0 | 63.500 0 | 88.900 0 | 114.300 0 | 139.700 0 | 165.100 0 | 190.500 0 | 215.900 0 | 241.300 0 | 266.700 0 | 292.100 0 |
| 33/64 | 0.515 625 | 13.096 9 | 38.496 9 | 63.896 9 | 89.296 9 | 114.696 9 | 140.096 9 | 165.496 9 | 190.896 9 | 216.296 9 | 241.696 9 | 267.096 9 | 292.496 9 |
| 17/32 | 0.531 25 | 13.493 8 | 38.893 8 | 64.293 8 | 89.693 8 | 115.093 8 | 140.493 8 | 165.893 8 | 191.293 8 | 216.693 8 | 242.093 8 | 267.493 8 | 292.893 8 |
| 35/64 | 0.546 875 | 13.890 6 | 39.290 6 | 64.690 6 | 90.090 6 | 115.490 6 | 140.890 6 | 166.290 6 | 191.690 6 | 217.090 6 | 242.490 6 | 267.890 6 | 293.290 6 |
| 9/16 | 0.562 5 | 14.287 5 | 39.687 5 | 65.087 5 | 90.487 5 | 115.887 5 | 141.287 5 | 166.687 5 | 192.087 5 | 217.487 5 | 242.887 5 | 268.287 5 | 293.687 5 |
| 37/64 | 0.578 125 | 14.684 4 | 40.084 4 | 65.484 4 | 90.884 4 | 116.284 4 | 141.684 4 | 167.084 4 | 192.484 4 | 217.884 4 | 243.284 4 | 268.684 4 | 294.084 4 |
| 19/32 | 0.593 75 | 15.081 2 | 40.481 2 | 65.881 2 | 91.281 2 | 116.681 2 | 142.081 2 | 167.481 2 | 192.881 2 | 218.281 2 | 243.681 2 | 269.081 2 | 294.481 2 |
| 39/64 | 0.609 375 | 15.478 1 | 40.878 1 | 66.278 1 | 91.678 1 | 117.078 1 | 142.478 1 | 167.878 1 | 193.278 1 | 218.678 1 | 244.078 1 | 269.478 1 | 294.878 1 |
| 5/8 | 0.625 | 15.875 0 | 41.275 0 | 66.675 0 | 92.075 0 | 117.475 0 | 142.875 0 | 168.275 0 | 193.675 0 | 219.075 0 | 244.475 0 | 269.875 0 | 295.275 0 |
| 41/64 | 0.640 625 | 16.271 9 | 41.671 9 | 67.071 9 | 92.471 9 | 117.871 9 | 143.271 9 | 168.671 9 | 194.071 9 | 219.471 9 | 244.871 9 | 270.271 9 | 295.671 9 |
| 21/32 | 0.656 25 | 16.668 8 | 42.068 8 | 67.468 8 | 92.868 8 | 118.268 8 | 143.668 8 | 169.068 8 | 194.468 8 | 219.868 8 | 245.268 8 | 270.668 8 | 296.068 8 |
| 43/64 | 0.671 875 | 17.065 6 | 42.465 6 | 67.865 6 | 93.265 6 | 118.665 6 | 144.065 6 | 169.465 6 | 194.865 6 | 220.265 6 | 245.665 6 | 271.065 6 | 296.465 6 |
| 11/16 | 0.687 5 | 17.462 5 | 42.862 5 | 68.262 5 | 93.662 5 | 119.062 5 | 144.462 5 | 169.862 5 | 195.262 5 | 220.662 5 | 246.062 5 | 271.462 5 | 296.862 5 |
| 45/64 | 0.703 125 | 17.859 4 | 43.259 4 | 68.659 4 | 94.059 4 | 119.459 4 | 144.859 4 | 170.259 4 | 195.659 4 | 221.062 5 | 246.459 4 | 271.859 4 | 297.259 4 |
| 23/32 | 0.718 75 | 18.256 2 | 43.656 2 | 69.056 2 | 94.456 2 | 119.856 2 | 145.256 2 | 170.656 2 | 196.056 2 | 221.456 2 | 246.856 2 | 272.256 2 | 297.656 2 |
| 47/64 | 0.734 375 | 18.653 1 | 44.053 1 | 69.453 1 | 94.853 1 | 120.253 1 | 145.653 1 | 171.053 1 | 196.453 1 | 221.853 1 | 247.253 1 | 272.653 1 | 298.053 1 |
| 3/4 | 0.75 | 19.050 0 | 44.450 0 | 69.850 0 | 95.250 0 | 120.650 0 | 146.050 0 | 171.450 0 | 196.850 0 | 222.250 0 | 247.650 0 | 273.050 0 | 298.450 0 |
| 49/64 | 0.765 625 | 19.446 9 | 44.846 9 | 70.246 9 | 95.646 9 | 121.046 9 | 146.446 9 | 171.846 9 | 197.246 9 | 222.646 9 | 248.046 9 | 273.446 9 | 298.846 9 |
| 25/32 | 0.781 25 | 19.843 8 | 45.243 8 | 70.643 8 | 96.043 8 | 121.443 8 | 146.843 8 | 172.243 8 | 197.643 8 | 223.043 8 | 248.443 8 | 273.843 8 | 299.243 8 |
| 51/64 | 0.796 875 | 20.240 6 | 45.640 6 | 71.040 6 | 96.440 6 | 121.840 6 | 147.240 6 | 172.640 6 | 198.040 6 | 223.440 6 | 248.840 6 | 274.240 6 | 299.640 6 |
| 13/16 | 0.812 5 | 20.637 5 | 46.037 5 | 71.437 5 | 96.837 5 | 122.237 5 | 147.637 5 | 173.037 5 | 198.437 5 | 223.837 5 | 249.237 5 | 274.637 5 | 300.037 5 |
| 53/64 | 0.828 125 | 21.034 4 | 46.434 4 | 71.834 4 | 97.234 4 | 122.634 4 | 148.034 4 | 173.434 4 | 198.834 4 | 224.234 4 | 249.634 4 | 275.034 4 | 300.434 4 |
| 27/32 | 0.843 75 | 21.431 2 | 46.831 2 | 72.231 2 | 97.631 2 | 123.031 2 | 148.431 2 | 173.831 2 | 199.231 2 | 224.631 2 | 250.031 2 | 275.431 2 | 300.831 2 |
| 55/64 | 0.859 375 | 21.828 1 | 47.228 1 | 72.628 1 | 98.028 1 | 123.428 1 | 148.828 1 | 174.228 1 | 199.628 1 | 225.028 1 | 250.428 1 | 275.828 1 | 301.228 1 |
| 7/8 | 0.875 | 22.225 0 | 47.625 0 | 73.025 0 | 98.425 0 | 123.825 0 | 149.225 0 | 174.625 0 | 200.025 0 | 225.425 0 | 250.825 0 | 276.225 0 | 301.625 0 |
| 57/64 | 0.890 625 | 22.621 9 | 48.021 9 | 73.421 9 | 98.821 9 | 124.221 9 | 149.621 9 | 175.021 9 | 200.421 9 | 225.821 9 | 251.221 9 | 276.621 9 | 302.021 9 |
| 29/32 | 0.906 25 | 23.018 8 | 48.418 8 | 73.818 8 | 99.218 8 | 124.618 8 | 150.018 8 | | | | | | |

QUALITY ASSURANCE TEST







SEMY

ENGINEERING & CONSULTING GMBH



Shipping Address:
Logistikstraße 7, C12
2201 Hagenbrunn,
Österreich



+43 676 4040215
+43 660 1100811



www.shop.semy.at



Billing Address:
Ullmannstraße 50/2-3,
1150 Wien, Österreich



office@semy.at

 **IZELTAS[®]**